

100 MHz Dual-Channel Oscilloscope PM3267/PM3267U

Service Manual

9499 445 01111
821207/01

S&I
Scientific & Industrial Equipment Division



PHILIPS

100 MHz Dual-Channel Oscilloscope PM3267/PM3267U

Service Manual

9499 445 01111
821207/01

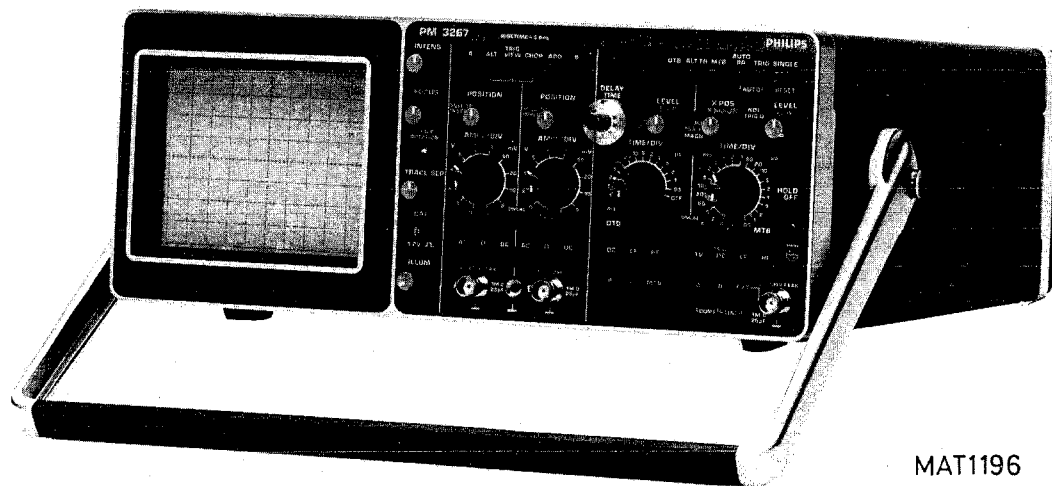

PHILIPS

IMPORTANT

In correspondence concerning this instrument, please quote the type number and serial number as given on the type plate.

NOTE: The design of this instrument is subject to continuous development and improvement. Consequently, this instrument may incorporate minor changes in detail from the information contained in this manual.

CONTENTS

Page

1. CHARACTERISTICS	1
1.1. Cathode ray tube	1
1.2. Vertical or Y-axis	1
1.3. Trigger view	3
1.4. Horizontal or X-axis	3
1.5. Triggering	5
1.6. Additional characteristics	6
1.7. Options	6
1.8. Mechanical data	8
1.9. Environmental characteristics	9
2. DESCRIPTION	14
2.1. Block diagram description	14
2.2. Circuit description of the vertical section	18
2.3. Circuit description of the horizontal section	25
2.4. C.R.T. display section, CAL generator and front-panel signal lamps	38
2.5. The power supply	39
2.6. Basic analog and digital circuits	44
3. DISMANTLING THE INSTRUMENT	49
3.1. General information	49
3.2. Removing the instruments covers	49
3.3. Access to parts necessary for the adjustment of the instrument	49
4. PERFORMANCE CHECK	52
4.1. General information	52
4.2. Preliminary settings of the controls	52
4.3. Recommended test equipment	53
4.4. Checking procedure	54
5. CHECKING AND ADJUSTING	76
5.1. General information	76
5.2. Recommended test equipment	76
5.3. Preliminary settings of the controls	76
5.4. Survey of adjusting elements and auxiliary equipment	77
5.5. Adjusting procedure	83
5.6. Adjustment interactions	94

6. CORRECTIVE MAINTENANCE	95
6.1. Important notes	95
6.2. Replacements	95
6.2.1. Standard parts	95
6.2.2. Special parts	95
6.2.3. Transistors and integrated circuits	95
6.2.4. Replacing knobs	96
6.2.5. Removing the carrying handle	96
6.2.6. Replacing the cathode ray tube	97
6.2.7. Removing the printed circuit boards	98
6.2.8. Soldering techniques	102
6.3. Recalibration after repair	102
6.4. Instrument repacking	102
6.5. Trouble-shooting	102
6.5.1. Introduction	102
6.5.2. Trouble-shooting hints	102
6.5.3. Checks after repair and maintenance	103
6.6. Optional MTB gate output, DTB gate output, MTB sweep output and TTL or ECL triggering	103
6.7. Accessory information	105
7. PARTS LIST	108
7.1. Parts indicated in the figures	108
7.2. Parts not indicated in the figures	114
7.3. Electrical parts	115
7.4. Location list of parts situated on the time-base unit A2	148
7.5. Location list of parts situated on the pre-amplifier and trigger unit 3	153
8. DIAGRAMS AND PRINT LAY-OUTS	161
8.1. Location of electrical parts	161
9. VOLTAGE-WAVEFORMS IN THE INSTRUMENT	202
9.1. Introduction	202
9.2. Vertical deflection and triggering	203
9.3. Horizontal deflection	210
9.4. Power supply	214
10. MODIFICATION	215

LIST OF FIGURES

Fig. 1.1.	Rise-time measurement	7
Fig. 1.2.	Dimensions of the instrument	8
Fig. 2.1.	Blockdiagram	12
Fig. 2.2.	Impedance converter	19
Fig. 2.3.	Continuous control circuit	20
Fig. 2.4.	Vertical channel selection logic	21
Fig. 2.5.	Important voltage waveforms in the MTB logic	30
Fig. 2.6.	Important voltage waveforms in the Z-modulation control logic	33
Fig. 2.7.	Important voltage waveforms in the alternate mode control logic	35
Fig. 2.8.	Important voltage waveforms in the DTB control logic	37
Fig. 2.9.	Converter-driver	40
Fig. 2.10.	Fly-back converter	41
Fig. 2.11.	Pulse-width modulation	42
Fig. 2.12.	Basic analog circuits	46
Fig. 2.13.	Basic digital circuits	46
Fig. 4.1.	Preliminary settings	51
Fig. 5.1.	Adjustment points top view	74
Fig. 5.2.	Adjustment points bottom view	74
Fig. 5.3.	Adjustment points right side	73
Fig. 5.4.	Geometry check	84
Fig. 5.5.	Dummy probe 2 : 1	87
Fig. 5.6.	Adjustment of HF square wave response	87
Fig. 6.1.	Removing the knobs	96
Fig. 6.2.	Removal of centre knobs from carrying handle	96
Fig. 6.3.	Removal of time-base unit	99
Fig. 6.4.	Time-base unit removed	99
Fig. 6.5.	Removal of pre-amplifier and trigger unit	99
Fig. 6.6.	Pre-amplifier and trigger unit removed	99
Fig. 6.7.	Over-compensation (C2), attenuator probe	105
Fig. 6.8.	Correct compensation (C2), attenuator probe	105
Fig. 6.9.	Under-compensation (C2), attenuator probe	105
Fig. 6.10.	Preset potentiometers correctly adjusted, attenuator probe	105
Fig. 6.11.	Rounding due to incorrectly adjusted potentiometers, attenuator probe	105
Fig. 6.12.	Overshoot due to incorrectly adjusted potentiometers, attenuator probe	105
Fig. 6.13.	Mechanical parts of attenuator probe	106
Fig. 6.14.	Electrical parts of attenuator probe	107
Fig. 7.1.	Mechanical parts, front view	109
Fig. 7.2.	Mechanical parts, rear view	109
Fig. 7.3.	Internal view of bottom view of instrument	111
Fig. 7.4.	Mechanical parts, top view	112
Fig. 7.5.	Mechanical parts, unit 3 and 4 removed	111
Fig. 7.6.	Mechanical parts, unit 2 removed	112
Fig. 7.7.	Time-base unit p.c.b. with component location raster	146
Fig. 7.8.	Pre-amplifier and trigger unit p.c.b. with component location raster	152

Fig. 8.1.	Pre-amplifier and trigger unit (unit 3), p.c.b. lay-out	164
Fig. 8.2.	Final Y amplifier (unit 5), p.c.b. lay-out	166
Fig. 8.3.	Circuit diagram, vertical deflection	170
Fig. 8.4.	Pre-amplifier and trigger unit (unit 3), p.c.b. lay-out	171
Fig. 8.5.	Circuit diagram main time base triggering (unit 3)	173
Fig. 8.6.	Circuit diagram delayed time base triggering (unit 3)	176
Fig. 8.7.	Trigger selection unit (unit 4), p.c.b. lay-out	177
Fig. 8.8.	Time base unit (unit 2), p.c.b. lay-out	179
Fig. 8.9.	Circuit diagram main time base	184
Fig. 8.10.	Time base unit (unit 2), p.c.b. lay-out	185
Fig. 8.11.	Circuit diagram delayed time base	188
Fig. 8.12.	Final X/Z amplifier unit (unit 5), p.c.b. lay-out	189
Fig. 8.13.	Circuit diagram final X-amplifier, Z-amplifier, calibration unit and display section	192
Fig. 8.14.	Power supply unit (unit 6), p.c.b. lay-out	193
Fig. 8.15.	Circuit diagram of power supply and H.V. generator	196
Fig. 8.16.	Switch unit (unit 102), p.c.b. lay-out	198
Fig. 8.17.	Potentiometer unit (unit 103), wiring lay-out	200

1. CHARACTERISTICS

This instrument has been designed and tested in accordance with IEC Publication 348 for Class II instruments* and UL1244** and has been supplied in a safe condition. The present Service Manual contains information and warnings that shall be followed by the purchaser to ensure safe operation and to retain the instrument in a safe condition.

- This specification is valid after the instrument has warmed up for 15 minutes (reference temperature 23°C).
- Properties expressed in numerical values with tolerance stated, are guaranteed by the manufacturer. Numerical values without tolerances are typical and represent the characteristics of an average instrument.
- Inaccuracies (absolute or in %) relate to the indicated reference value.

1.1. CATHODE RAY TUBE

Measuring area	8 cm x 10cm.
Screen type	P31 phosphor (GH). Phosphors optionally available: P7 (GM), long persistence. P11 (BE), blue, high photographic writing speed.
Acceleration voltage	10kV.
Display resolution	20 lines/div in vertical and horizontal direction.
Orthogonality	Angle between X and Y trace $90^{\circ} \pm 1^{\circ}$.
Engravings	cm divisions with 2mm subdivisions along central axes and 3rd and 7th horizontal graticule lines. Dotted lines at 1.5 and 6.5 div from top of display area.
Trace rotation	Provides adjustment of a horizontal trace in parallel with graticule lines. Screwdriver-operated adjustment at front panel. Minimum overrange 4° .

1.2. VERTICAL OR Y-AXIS

Display modes	<ul style="list-style-type: none"> – Channel A only – Channel B only – Trigger view only – Channels A and B chopped – Channels A and B alternated – Channels A, B and trigger view chopped – Channels A, B and trigger view alternated – Channel A and B added
Polarity inversion	Channel A and B can be inverted
Chopped mode: display time per channel	900ns
blanking time per channel	100ns
Frequency response (Ch. A and B) DC coupled	DC .. 100MHz (–3dB)
AC coupled	2Hz ... 100MHz (–3dB)
Derated bandwidth in 2,5 and 10mV/div	DC ... 80MHz (–3dB)
Rise-time (Ch. A and B)	≤ 3.5 ns
Derated rise-time in 2,5 and 10mV/div	≤ 4.4 ns

Pulse aberrations (Ch. A and B)	<p>$\leq 3\%$ ($\leq 4\%$ p.p.)</p> <p>Outside the centre 6 div additional pulse aberrations of 1%. In added and invert mode additional pulse aberrations of 1%.</p>
Deflection coefficients	<p>2mV/div ... 10V/div in 1-2-5 sequence.</p> <p>Uncalibrated continuous control between the steps.</p> <p>Operation indicated by uncal LED.</p>
Error limit	3%
Input impedance	<p>$1\text{m}\Omega (\pm 1\%)$ in parallel with $25\text{pF} (\pm 2.5\text{pF})$.</p> <p>Difference in input cap. of vertical and trigger inputs $\leq 2\text{pF}$.</p>
**  Max. safe input voltage	400V (DC + AC peak)
* Rated input voltage	42V (DC + AC peak)
** PM3267U only	Test voltage 500V (rms) according to IEC348.
* PM3267 only	
Dynamic range	<p>24 div up to 40MHz.</p> <p>8 div up to 100MHz.</p>
Shift range	+ and - 8 div from screen centre.
Linearity error	$\leq 3\%$ Non linearity of CRT included. Measured at a frequency of 50kHz.
Visible signal delay	30ns approx. at max. intensity and well-focused display.
Base line instability	<p>≤ 0.2 div between AMPL/DIV steps.</p> <p>Additional 0.2 div when switching between 20mV/div, 10mV/div, 5mV/div and 10mV/div</p> <p>≤ 1 div when operating the invert switch.</p> <p>≤ 2 div: 10mV ... 2mV/div</p> <p>≤ 0.6 div when switching to or from added mode.</p> <p>≤ 0.3 div when rotating the continuous AMPL/DIV control.</p>
Base line drift	$\leq 0.5\text{div/h.}$ measured in 2mV/div
Base line temp. coefficient	≤ 0.025 div/K. measured in 2mV/div
Decoupling factor	<p>≥ 40 dB at 50MHz</p> <p>≥ 35 dB at 100MHz</p> <p>Input signal at one channel (up to full screen) shall not cause a display via the other channel, more than given by the stated value, according to IEC351.</p> <p>≤ 0.2 div at equal AMPL/DIV settings.</p>
Common mode rejection ratio (CMRR)	<p>≥ 100 at 2MHz</p> <p>≥ 20 at 50MHz</p> <p>≥ 10 at 100MHz</p> <p>All measured at 8 div common mode signal, after adjustment of continuous AMPL/DIV for max. CMRR and in equal AMPL/DIV settings.</p>

1.3. TRIGGER VIEW

Trigger view	Display of internal or external main time-base trigger signal.
Frequency response	internal: DC ... 60MHz external: DC ... 70MHz Both in DC trigger coupling.
Rise-time	internal: $\leq 5.8\text{ns}$ external: $\leq 5\text{ns}$ Both in DC trigger coupling.
Pulse aberrations	internal: 10% p.p. pushbutton MTB of S22 depressed. external: $\leq 6\%$ ($\leq 8\%$ p.p.)
Deflection coefficients	internal: see Ch. A or B deflection coefficients. external: 200mV/div.
Error limit	internal: $\leq 10\%$ external: $\leq 3\%$
Trigger point	In screen centre ± 0.3 div.
Time delay between trig. view via external trigger input and vertical channels	6ns
Dynamic range	+ and - 8 div up to 40MHz

1.4. HORIZONTAL OR X-DEFLECTION

Display modes	MTB (main time-base) MTB intensified DTB (delayed time-base) MTB and DTB in alternate time-base mode EXT X deflection via MTB trigger source
Trace separation	Symmetrical vertical separation between MTB and DTB of ≥ 5 div
Main time-base	
MTB modes	Auto pp, Auto, Trig, Single In Auto pp and Auto modes a bright base line is displayed if no trigger signal is present. In Auto pp the trigger level is adjustable between the max and min value of the trigger signal. In Auto mode the trigger level range is independent on the trigger signal. In SINGLE the NOT TRIG'D LED is on after reset of the time-base and extinguishes after the start of the time-base.
Position range	+ and - 5 div from screen centre
Horizontal drift	≤ 0.5 div/h.
Horizontal temp. coefficient	≤ 0.025 div/K.
MTB time coefficients	50ns/div ... 0.5 s/div in 1-2-5- sequence. Uncalibrated continuous control between the steps. Operation indicated by uncal LED.
Error Limit	$\pm 3\%$. Measured over centre 8 div of screen.
Expansion (X MAGN pulled)	X10

Additional error in X MAGN mode	$\pm 2\%$. Excluded are the first and last 50ns of which additional error is $\pm 5\%$. Measured over centre 8 div of screen.
Expansion balance	1 div O-jump between expanded and unexpanded sweep should not deviate from centre graticule more than the specified value.
Linearity	5%. Excluded are the first and last 50ns. Deviation of first and last div with respect to centre 8 div.
Hold off	Continuously adjustable up to 10x minimum value.
Delayed time-base	
DTB modes	Started after delay time. Triggered upon first trigger after delay time.
Position range	} see main time-base
Horizontal drift	
Horizontal temp. coefficient	
Error limit	
Expansion (X MAGN pulled)	
Additional error in X MAGN mode	
Expansion balance	
Linearity	
DTB time coefficients	50ns/div ... 1ms/div in 1-2-5- sequence. Uncalibrated continuous control between the steps. Operation indicated by uncal LED.
Delay time	Variable between 5s and 500ns.
Delay time error limit	$\pm 3\% + 60\text{ns}$.
Incremental delay error limit	0.5%
Delay time jitter	1 : ≥ 20.000 . Regardless of sweep speed.
External X deflection	
Frequency response	DC ... 100kHz (-0.5dB). MTB trigger coupling in DC. For frequency response in non DC coupling refer to MTB trigger coupling.
Deflection coefficients	internal: see Ch. A and B deflection coefficients. external X input: 200mV/div.
Error limit	10%. Via Ch. A, Ch. B or external X input.
Expansion	X10
Additional error limit	2%
Input impedance	$1\text{M}\Omega (\pm 1\%)$ in parallel with $25\text{pF} (\pm 2.5\text{pF})$. Input impedance such that a 10 : 1 attenuator probe after being adjusted on Ch. A or B can be applied to the ext. trig. input without readjustment.
**  Max. safe input voltage	400V (DC + AC peak)
* Rated input voltage	42V (DC + AC peak)
** PM3267U only	Test voltage 500V (rms) according to IEC348.
* PM3267 only	

Dynamic range	≥ 20 div
Position range	+ or - 5 div from screen centre
Linearity error	$\leq 5\%$
Compression	$\leq 1\%$
Phase shift between X and Y deflection	$\leq 3^\circ$ at 100kHz
Horizontal drift	≤ 0.5 div/h. Measured at 2mV/div.
Horizontal temp. coefficient	≤ 0.025 div/K. Measured at 2mV/div.
X-deflection via line	8 div ($\pm 10\%$) at line frequency.

1.5. TRIGGERING

Triggering of main time-base

Source	Ch. A, Ch. B, composite, external line.
Trigger coupling	DC, LF, HF. Bandpass: DC: DC ... full bandwidth LF: 2Hz ... 25kHz (External 7Hz ... 25kHz). HF: 25kHz ... full bandwidth Lower frequency limit 10Hz in auto and auto pp mode.
Slope	Positive or negative
Level range: trig, auto, single	internal: + and - 8 div external: + 1.6V and - 1.6V
auto pp	Within pp value of trigger signal.
TV	Fixed level.
Sensitivity (in DC mode)	internal: 0.5 div up to 40MHz 1.5 div up to 100MHz external: 100mV up to 40MHz 300mV up to 100MHz
TV triggering	Positive and negative video selection via slope switch. TV frame triggering at MTB TIME/DIV 0.5 s/div ... 50 μ s/div. TV line triggering at MTB TIME/DIV 20 μ s/div ... 50ns/div.
TV trigger sensitivity	internal: 0.7 div synch. pulse. external: 150mV synch. pulse.
NOT TRIG'D LED	LED is on in absence of trigger signal.

Triggering of delayed time-base

Source	Ch. A, Ch. B, MTB. In MTB mode the DTB starts immediately after the delay time.
Trigger coupling	} See main time-base triggering.
Slope	
Level range	
Sensitivity	

1.6. ADDITIONAL CHARACTERISTICS

Calibration voltage generator

Output	1.2V rectangular. Starting from zero level negative going.
Error limit	$\pm 1\%$. ($\geq 1M\Omega$ load impedance)
Frequency	2kHz approx.

Additional input

External Z-modulation	DC coupled TTL compatible "1" is normal intensity "0" blanks display
Min. required pulse width	10ns

Power supply

AC ranges	90 ... 132V 195 ... 245V 210 ... 270V
Power consumption	45W
AC frequency	46 ... 440Hz
DC range	20 ... 32V
DC current	1.45A at 24V

1.7. OPTIONS

TTL triggering

Internal	The correct TTL level is obtained with the AMPL/DIV in position 2V/div.
External	The correct TTL level is obtained via a 10 : 1 attenuator probe.

ECL triggering

Internal	The correct ECL level is obtained with the AMPL/DIV in position 0.5V/div.
----------	---

NOTE: Instead of TV triggering, you can modify the instrument for TTL or ECL triggering. If modified the main time-base triggering is automatically set for TTL or ECL triggering. The level control is not operative then.

Sweep out MTB

Output voltage	From $-1.8V$ to $+3.8V$. Output short-circuit protected.
----------------	--

Gate out MTB

Output voltage	At TTL level: "high" during MTB sweep. Output short-circuit protected.
----------------	---

Gate out DTB

Output voltage	At TTL level: "high" during DTB sweep. Output short-circuit protected.
----------------	---

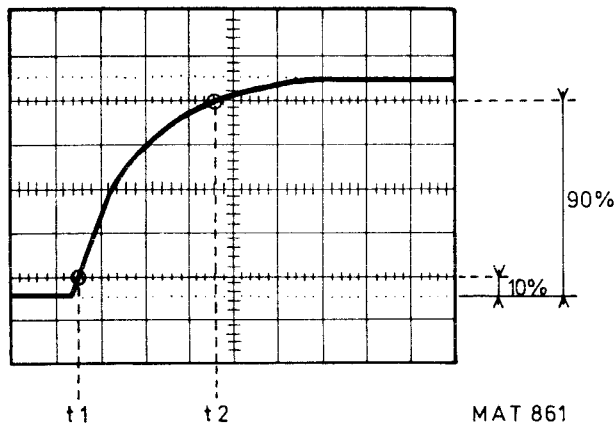

Fig. 1.1. Rise-time measurement $t_R = t_2 (90\%) - t_1 (10\%)$ (general formula)

$$\text{Rise-time of oscilloscope} = \frac{0.35}{\text{bandwidth (Hz) of the instrument}}$$

NOTE: Bear in mind that inaccuracies of CRT and time-base and rise-time of generator (measured with an input pulse with a rise-time $\leq 1\text{ns}$) influence this measurement.

Rise-time measurement of a signal applied to the vertical inputs:

Bear in mind that the rise-time measured on the oscilloscope screen is influenced by the rise-time of the oscilloscope according to the formula:

$$T_R (\text{measured}) = \sqrt{(T_R (\text{signal})^2 + (T_R (\text{oscilloscope})^2)}$$

The measuring fault $\leq 3\%$, if the rise-time of the input pulse is ≥ 4 times the rise-time of the oscilloscope.

1.8. MECHANICAL DATA

Dimensions:

Depth	445mm.	Handle and controls excluded
Width	335mm.	Handle excluded
Height	137mm.	Feet excluded
Mass	10.6 kg. (23,3 lb)	

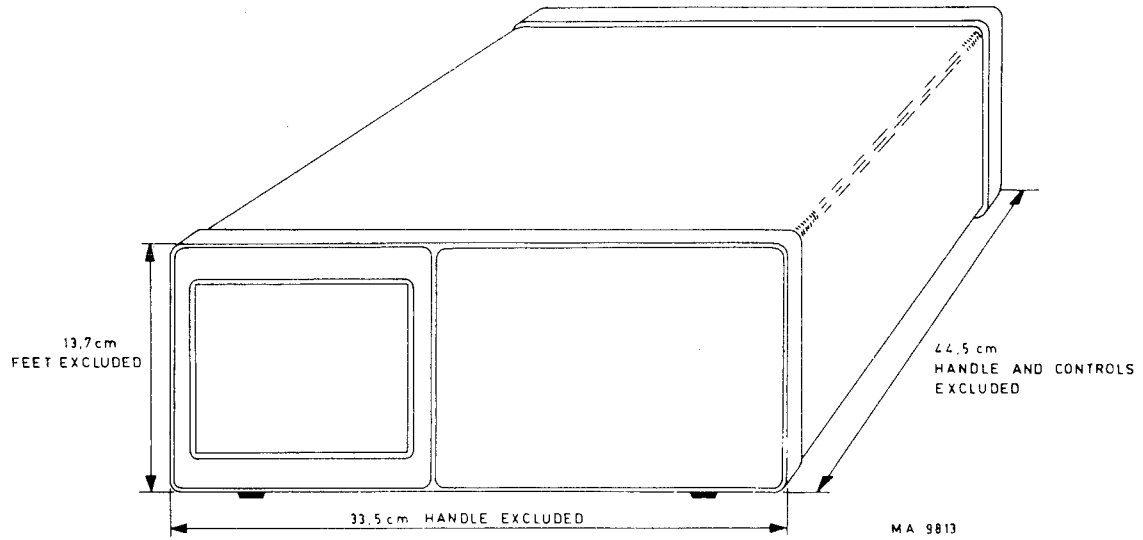
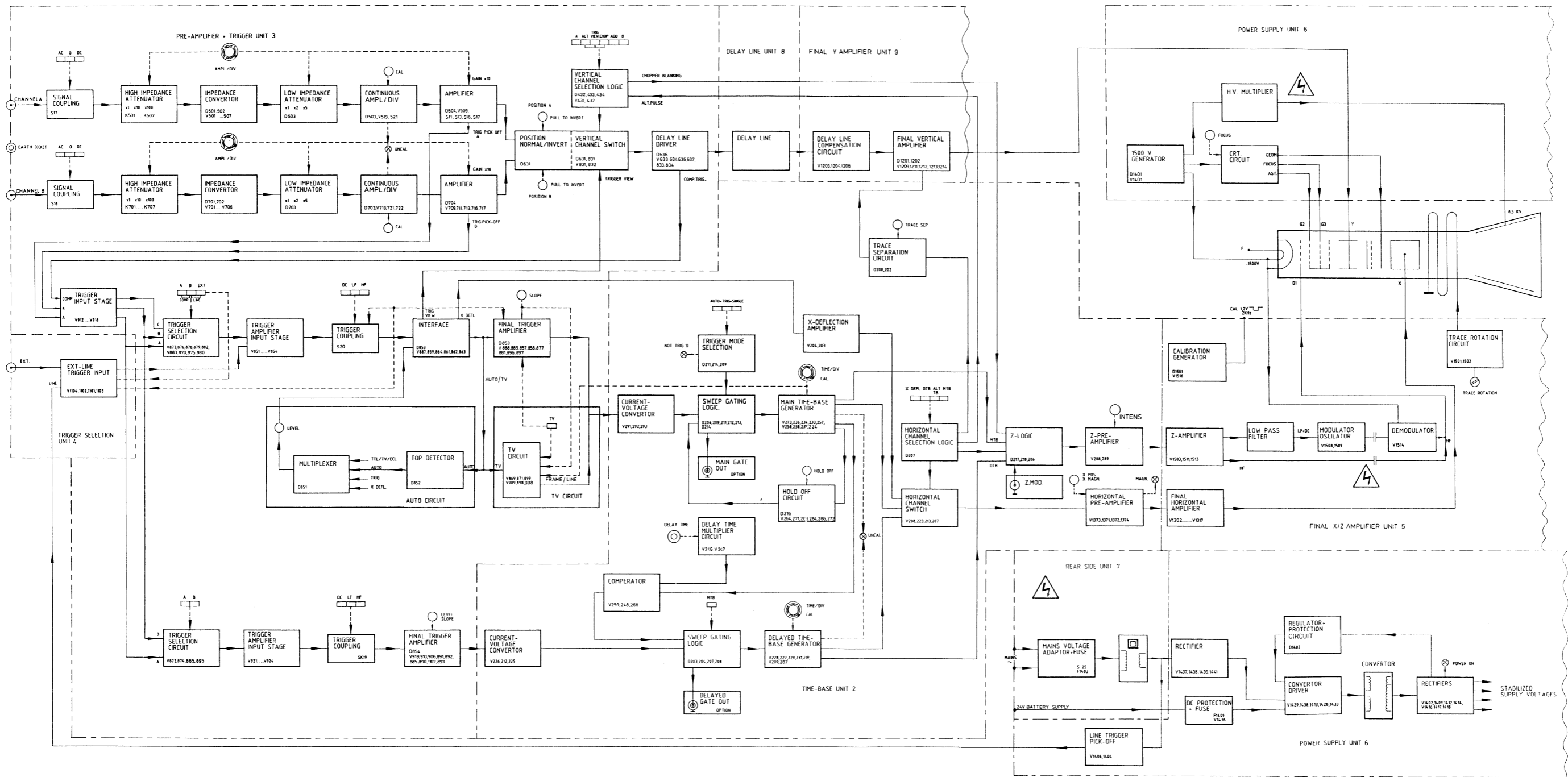

Fig. 1.2. Dimensions of instrument

1.9. ENVIRONMENTAL CHARACTERISTICS

NOTE: The characteristics are valid only if the instrument is checked in accordance with the official checking procedure. Details on these procedures and failure criteria are supplied on request by the PHILIPS-organisation in your country, or by N.V. PHILIPS' GLOEILAMPENFABRIEKEN, TEST AND MEASURING DEPARTMENT, EINDHOVEN, THE NETHERLANDS.

Ambient temperature	
Rated range of use	0°C ... +40°C
Limit range of operation	-10°C ... +55°C
Storage conditions	-40°C ... +70°C
Humidity	According to IEC68 dB
Bump	300m/s ² half sine 11ms duration, 3 shocks per direction with a total of 18
Vibration	20 minutes in each of 3 directions, 5 ... 55Hz 1mm (PP) and 40m/s ² max. acceleration
Altitude	Limit range of operation: 5000m (15000 feet) Limit range of transport: 15000m (50000 feet)
Recovery time	30 min. if ambient temperature is raised from -10°C to +20°C at 60% relative humidity.
Electromagnetic interference	Meets VDE 0871 and VDE 0875 Grenzwertklasse B.



MAT 159

Fig. 2.1. Block diagram

2. CIRCUIT DESCRIPTION

2.1. BLOCK DIAGRAM DESCRIPTION (see Fig. 2.1.)

2.1.1. Vertical Deflection

The vertical deflection system is located on the PRE-AMPLIFIER + TRIGGER UNIT 3, DELAY LINE UNIT 8 AND FINAL AMPLIFIER UNIT 9.

The instrument has two identical vertical channels, A and B: only channel A is described.

Channel A vertical input signal is fed via the SIGNAL COUPLING switch AC-0-DC (S17) to the HIGH IMPEDANCE ATTENUATOR, which is controlled via reed relays by the AMPL/DIV switch. Attenuation factors of x1, x10 and x100 are achieved in this portion of the attenuator circuit.

The IMPEDANCE CONVERTER adapts the output of the HIGH IMPEDANCE ATTENUATOR to the input of the LOW IMPEDANCE ATTENUATOR, which is also controlled via reed relays by the AMPL/DIV switch to give attenuations of x1, x2 and x5.

For the three most sensitive ranges (2-5-10 mV/div), the signal is amplified by a factor of 10. This is achieved in the AMPLIFIER circuit controlled by the AMPL/DIV switch.

Via the CONTINUOUS AMPL/DIV, controlled by the AMPL/DIV continuous control, the signal is fed to the AMPLIFIER circuit. The AMPLIFIER stage converts the voltage signal into a current signal.

From the TRIG. PICK-OFF of the AMPLIFIER, the channel A trigger signal is routed to both time-bases.

Returning to the display signal path, the output signal of the AMPLIFIER is fed to an integrated circuit comprising the vertical POSITION, the NORMAL/INVERT circuit and the VERTICAL CHANNEL SWITCH circuit. The vertical POSITION control circuit allows vertical shift of the c.r.t. trace. Incorporated in the POSITION control, the PULL TO INVERT switch controls the NORMAL/INVERT circuit.

The VERTICAL CHANNEL SWITCH is controlled by the vertical display mode switches A, ALT, TRIG VIEW, CHOP, ADD, B, via the VERTICAL CHANNEL SELECTION LOGIC circuit. In ALT mode, the A and B channel switching is controlled by the ALT pulse derived from the HORIZONTAL CHANNEL SELECTION LOGIC.

In the CHOP mode, the switching period between channels A and B is blanked by the Z amplifier (via the Z-logic) controlled by the CHOPPER BLANKING signal derived from the VERTICAL CHANNEL SELECTION LOGIC.

The TRIG VIEW signal, derived from the MTB trigger INTERFACE, can also be selected by the vertical display mode switches to enable display of the MTB trigger signal.

When the pushbutton ADD is depressed, the input signals of both vertical channels are added.

From the VERTICAL CHANNEL SWITCH, the selected vertical signal is fed via the DELAY LINE DRIVER to the DELAY LINE.

In the DELAY LINE DRIVER the current signal is converted to a voltage signal and the common-mode signals are also suppressed in this stage.

The COMP. TRIG. signal is routed to the TRIGGER INPUT STAGE of the time-base for composite triggering. From the DELAY LINE DRIVER, the adapted output signal is fed to the DELAY LINE, which gives sufficient delay to ensure that the steep leading edges of fast signals are displayed.

To reduce and to compensate for interference and distortion originating in the DELAY LINE, the signal is fed to the DELAY LINE COMPENSATION CIRCUIT before being applied to the FINAL VERTICAL AMPLIFIER. The vertical distance on the screen between the traces of the two time-bases in the ALT TB mode, is controlled by the trace separation signal applied to the FINAL VERTICAL AMPLIFIER.

The output signal of the FINAL VERTICAL AMPLIFIER feeds the vertical deflection plates of the c.r.t.

2.1.2. Horizontal Deflection

The triggering circuits for both the MTB and the DTB are located on the PRE-AMPLIFIER - TRIGGER UNIT 3. Both the main time-base and the delayed time-base are located on the TIME-BASE UNIT 2.

The FINAL HORIZONTAL AMPLIFIER and the Z-AMPLIFIER are situated on the FINAL AMPLIFIER UNIT 5.

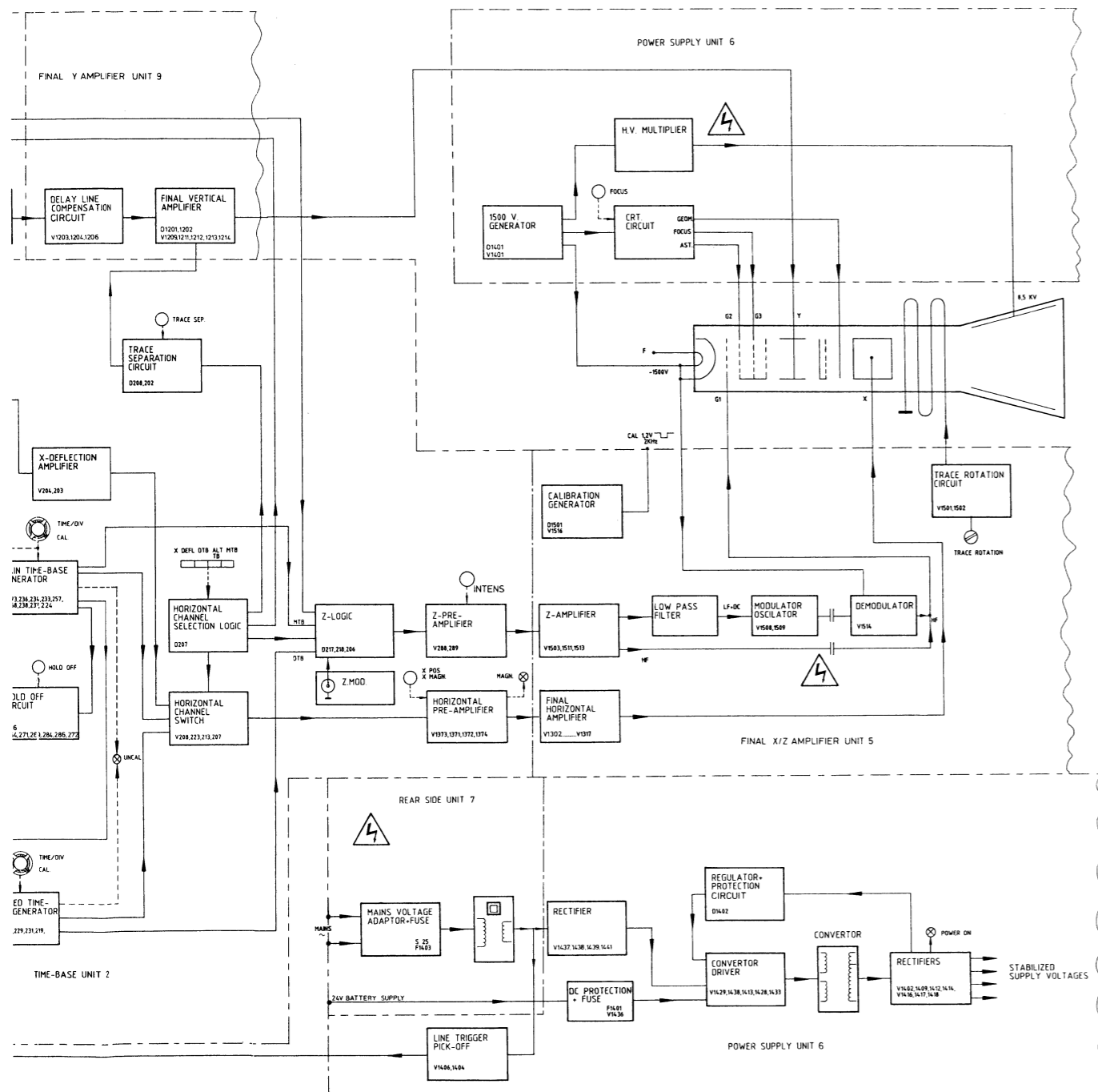

The trigger signals derived from the AMPLIFIER circuits of channel A and B, and from the DELAY LINE DRIVER are routed to the TRIGGER INPUT STAGE. These signals are in current form, which makes them less sensitive to interference; often a problem with long signal wires. In the TRIGGER INPUT STAGE, these current signals are converted into voltage form, and fed to the TRIGGER SELECTION CIRCUIT. The EXT trigger signal from the EXT input socket, and the LINE signal from the LINE TRIGGER PICK-OFF are fed to the TRIGGER SELECTION CIRCUIT via the EXT-LINE TRIGGER INPUT circuit. In this stage, the EXT and LINE trigger signals are converted to symmetrical current signals and adapted to the A, B and COMP signals. The EXT-LINE TRIGGER INPUT stage is controlled by the EXT pushbutton and LINE (pushbuttons B and EXT depressed simultaneously). In addition, the A and B trigger signals are fed to the TRIGGER SELECTION CIRCUIT of the DTB.

2.1.2.1. Main time-base

The trigger signals are selected by the MTB trigger source switches A, B, EXT, COMP, LINE, which control the TRIGGER SELECTION CIRCUIT.

Common-mode interference is reduced by using a symmetrical configuration for the TRIGGER SELECTION CIRCUIT output signal. This output current signal is fed to the TRIGGER AMPLIFIER INPUT STAGE. This stage converts the symmetrical current signal to an asymmetrical voltage signal, which is fed to the INTERFACE via the TRIGGER COUPLING stage. The coupling is controlled by the MTB trigger coupling switches DC, LF, HF.

Several signals are produced by the INTERFACE, e.g. X DEFL, TRIG VIEW and AUTO/TV.

The X-DEFL signal is an asymmetrical signal that is fed to the X DEFLECTION AMPLIFIER.

The symmetrical TRIG VIEW signal is routed to the VERTICAL CHANNEL SWITCH; the asymmetrical AUTO/TV signal is routed to the AUTO and TV CIRCUIT.

The FINAL TRIGGER AMPLIFIER comprises the SLOPE circuit under the control of the SLOPE switch incorporated in the LEVEL control. It permits positive and negative triggering.

The output of the FINAL TRIGGER AMPLIFIER is fed to the CURRENT-VOLTAGE CONVERTER.

In the AUTO CIRCUIT, the TOP DETECTOR detects the amplitude of the AUTO SIGNAL. When in the AUTO Mode, the LEVEL range is determined by this detected amplitude. The MULTIPLEXER is an electronic switch which, depending on the selected mode, selects the different ranges for the LEVEL control.

Each mode has its own specific LEVEL range, for example:

TV	: fixed level
AUTO	: determined by TOP DETECTOR
TRIG	: ± 8 divisions
X DEFL	: 0 divisions (LEVEL inoperative)

If the instrument is provided with the TTL/ECL option, the TV pushbutton will function as the TTL or ECL mode switch.

The TV trigger signal is fed to the TV CIRCUIT.

When the TV pushbutton is selected, the TV CIRCUIT is inserted between the INTERFACE and the CURRENT-VOLTAGE CONVERTER of the MTB.

In the TV mode, the FINAL TRIGGER AMPLIFIER is switched off and also the LEVEL control is inoperative, a fixed trigger level being set.

For FRAME and LINE synchronisation, a frame or line filter is selected with the MTB TIME/DIV switch. Via the CURRENT-VOLTAGE CONVERTER, the trigger signal is routed to the SWEEP-GATING LOGIC.

The SWEEP-GATING LOGIC determines the start of the MAIN TIME-BASE GENERATOR sweep.

The SWEEP-GATING LOGIC is controlled by signals derived from the TRIGGER MODE SELECTION, the HOLD-OFF CIRCUIT and the CURRENT-VOLTAGE CONVERTER.

The TRIGGER MODE SELECTION is controlled by the MTB trigger mode selection pushbuttons AUTO, TRIG, SINGLE. In the AUTO mode, the MAIN TIME-BASE GENERATOR runs automatically when no trigger pulses are available.

In the TRIG mode, the MAIN TIME-BASE GENERATOR must be normally triggered by trigger signals derived from the CURRENT-VOLTAGE CONVERTER.

If the SINGLE pushbutton is selected, the SWEEP-GATING LOGIC will start the MAIN TIME-BASE GENERATOR for one sweep.

The MAIN GATE OUT signal (optional) is taken from the SWEEP-GATING LOGIC

This MAIN GATE OUT signal output is at logic H during the MTB sweep and L for other conditions.

The NOT TRIG LED lights up when the MTB is not triggered.

The MAIN TIME-BASE GENERATOR produces a sawtooth voltage, the repetition time being controlled by the TIME/DIV switch. To enable the capacitors that determine the repetition rate sufficient time to discharge, the HOLD-OFF CIRCUIT is employed. This time is adjustable with the HOLD-OFF control.

After the HOLD-OFF time, the HOLD-OFF CIRCUIT sends a signal to the SWEEP-GATING LOGIC, which in turn starts the next time-base sweep.

The repetition rate of the MTB sawtooth voltage is continuously variable with the continuous control CAL. The output sawtooth voltage from the MTB is fed to the HORIZONTAL CHANNEL SWITCH circuit.

2.1.2.2. *Delayed time-base*

Channel A and B trigger signals are fed to the DTB TRIGGER SELECTION CIRCUIT via the TRIGGER INPUT STAGE.

Trigger selection is controlled by the DTB trigger source selection pushbuttons A, B.

The symmetrical output current signal from the TRIGGER SELECTION CIRCUIT is converted to an asymmetrical voltage signal in the TRIGGER AMPLIFIER INPUT STAGE. This signal is then fed via the TRIGGER COUPLING circuit to the FINAL TRIGGER AMPLIFIER. Trigger coupling is selected by the DC, LF, HF pushbuttons.

The FINAL TRIGGER AMPLIFIER comprises the LEVEL/SLOPE controls and their associated circuits. The asymmetrical input voltage signal is converted to an asymmetrical current signal, which is fed to the CURRENT-VOLTAGE CONVERTER.

The output of the CURRENT-VOLTAGE CONVERTER and the output of the COMPARATOR are fed to the SWEEP-GATING LOGIC.

The COMPARATOR circuit compares the amplitude of the MTB sawtooth voltage with a d.c. voltage selected by the DELAY TIME control. If the amplitude of the MTB sawtooth is equal to the d.c. voltage, the COMPARATOR produces a signal that is then fed to the SWEEP-GATING LOGIC.

If the MTB pushbutton of the delayed time-base trigger source switches is depressed, the SWEEP-GATING LOGIC starts the DELAYED TIME-BASE GENERATOR immediately after the DELAY TIME selected.

If the A or B pushbutton is depressed, the SWEEP-GATING LOGIC detects the end of the delay time but waits for a trigger signal (A or B) from the CURRENT-VOLTAGE CONVERTER, after which the TIME-BASE GENERATOR starts.

The DELAYED GATE OUT is taken from the SWEEP-GATING LOGIC when this option is available. The output is at logic H during the DTB sweep and L for other conditions.

The DTB sawtooth voltage is produced in the DELAYED TIME-BASE GENERATOR under the control of the TIME/DIV switch and its continuous CAL control.

If the UNCAL LED lights up, it indicates that the continuous controls of one or both time-bases are not in the CAL position.

2.1.2.3. *Horizontal channel selection and final horizontal amplifier*

In the X DEFLECTION AMPLIFIER the X DEFL signal derived from the MTB INTERFACE is amplified and fed to the HORIZONTAL CHANNEL SWITCH circuit.

The HORIZONTAL CHANNEL SWITCH selects the X DEFL, MTB and/or DTB signals under the control of the HORIZONTAL CHANNEL SELECTION LOGIC, which in turn is controlled by the horizontal display mode switches X DEFL, DTB, ALT TB, MTB.

If the X DEFL pushbutton is selected, the signal chosen by the MTB trigger source selection switches A, B, EXT, LINE, will determine the horizontal deflection.

Horizontal deflection is performed by the sawtooth output of the DELAYED TIME-BASE GENERATOR if the DTB pushbutton is selected.

Similarly, the MTB pushbutton selects the MAIN TIME-BASE GENERATOR sawtooth for horizontal deflection.

If the ALT TB pushbutton is selected, the HORIZONTAL CHANNEL SWITCH alternates from the MTB sawtooth to the DTB sawtooth voltage at the end of every time-base sweep.

The selected signal is routed to the FINAL HORIZONTAL AMPLIFIER via the HORIZONTAL PRE-AMPLIFIER. This pre-amplifier comprises the X POS potentiometer for horizontal shift of the trace, and its associated circuit. It also includes the X MAGNIFIER for x10 magnification of the horizontal deflection. If the X MAGN push-pull switch, incorporated in the X POS control, is pulled for x10 magnification the MAGN LED lights-up.

The signal is converted into symmetrical current form in the HORIZONTAL PRE-AMPLIFIER and fed to the FINAL HORIZONTAL AMPLIFIER to drive the horizontal deflection plates of the c.r.t.

2.1.3. CRT Display Section

The Z-LOGIC and Z PRE-AMPLIFIER stages are part of the TIME-BASE UNIT 2.

The Z-AMPLIFIER, CALIBRATION GENERATOR and TRACE ROTATION CIRCUIT are located on the FINAL AMPLIFIER UNIT 5. The supply voltages for the c.r.t. are derived from the POWER SUPPLY UNIT 6.

The Z-LOGIC receives the following inputs to drive the Z PRE-AMPLIFIER and Z-AMPLIFIER:

- The external Z-MOD signal applied to the BNC connector on the rear panel. This Z-MOD signal must be TTL-compatible. An L level in gives trace blanking.
- Two signals produced in the MTB and DTB to unblank the trace during the sweeps.
- The chopper blanking signal from the VERTICAL CHANNEL SELECTION LOGIC to blank the trace during switching between channels A and B in the chopped mode.

The output signal from the Z-LOGIC that determines trace blanking or unblanking is routed to the Z PRE-AMPLIFIER. Here the trace intensity is determined by the front-panel INTENS potentiometer setting. In the Z AMPLIFIER, after amplification the Z-signal is split into two paths, an l.f. + d.c. and an h.f. path, because of the potential difference that exists between the Z AMPLIFIER output and the c.r.t. cathode (-1500 V).

The h.f. signals are fed via a high voltage capacitor directly to grid G1 of the c.r.t.

However, the d.c. and l.f. signals are blocked by this capacitor. These signals therefore are used to modulate an oscillator frequency, which is then passed via another high voltage capacitor and demodulated in the DEMODULATOR stage to retrieve the original signal.

The original h.f. and d.c. + l.f. signals are recombined on the grid G1

The c.r.t. supply voltages are derived from the 1500 V GENERATOR.

The CRT CIRCUIT comprises the FOCUS control circuit for the electron beam, and the preset potentiometers for GEOMETRY and ASTIGMATISM.

The post-acceleration anode potential of 8,5 kV is produced in the HV MULTIPLIER and derived from the -1500 V cathode supply.

A preset front-panel control TRACE ROTATION enables the trace to be aligned in parallel with the graticule lines. This preset controls the TRACE ROTATION CIRCUIT that drives the trace rotation coil situated on the c.r.t.

2.1.4. Power Supply

The instrument may be powered either by an a.c. supply voltage or by a 24 V battery supply voltage.

By means of the MAINS VOLTAGE ADAPTOR the instrument can be set to the local mains voltage. This circuit incorporates a fuse for the a.c. supply.

This a.c. supply voltage is fed via the double-insulated mains transformer to the full-wave RECTIFIER. A LINE trigger signal at mains frequency is fed via the LINE TRIGGER PICK-OFF circuit to the EXT-LINE TRIGGER INPUT.

From the RECTIFIER the unregulated d.c. supply is fed to the CONVERTER DRIVER. When a 24 V battery supply is used, this is fed via the DC PROTECTION + FUSE stage to the CONVERTER DRIVER. This protection stage safeguards the instrument against reversed polarity of the battery supply source.

THE CONVERTER DRIVER stage drives the CONVERTER transformer. The rectified +14V output-voltage is fed back as control via the REGULATOR + PROTECTION circuit.

In this way, the voltages on the secondary windings of the CONVERTER transformer are stabilised. After rectification and smoothing, the stabilised supply voltages are fed to the various electronic circuits in the instrument.

2.2. CIRCUIT DESCRIPTION OF THE VERTICAL SECTION

As the channel A and B attenuators are almost identical, only the channel A is described.

2.2.1. Input Signal Coupling (see Fig. 8.3.)

Input signals applied to input socket A (X2) can be either a.c.-coupled, d.c.-coupled or internally disconnected, depending on the coupling mode switch position of S17 (AC-O-DC).

In the AC position (S17A points 2 and 3) a blocking capacitor C501 paralleled by series circuit R502 and C502 are inserted in the signal path which prevents the d.c. component being applied to the attenuator. In this mode, the lower frequency limit is 2 Hz and some pulse droop may occur when low-frequency square-wave signals are displayed.

When DC is selected (S17A points 1 and 2 and S17B points 4 and 5) the complete input signal (a.c. + d.c. components) is fed to the attenuator input R503, R504, R506. Thus the full bandwidth of the oscilloscope is available.

If the 0 pushbutton is depressed, the input signal is isolated from the attenuator and the attenuator input is earthed, as a reference for calibration or trace centering, etc.

2.2.2. Attenuator and Impedance Converter (see Fig. 2.2. and 8.3)

The attenuator consists of a triple high-impedance voltage divider, an impedance converter and a low-impedance voltage divider.

High-impedance and low-impedance attenuator

The overall attenuation is determined by the combinations of the selected sections of the high- and low-impedance attenuator.

The voltage dividers of the high-impedance attenuator are controlled by reed relays.

Reed relay K503 and K504 are activated in the AMPL/DIV (S9) positions 2 mV/DIV ... 100 mV/DIV (x 1 stage).

In the 0.2 V/DIV ... 1 V/DIV positions of S9, reed relays K506 and K507 are activated. The input signal is x10 attenuated by voltage divider R514 and R516.

When positions 2 V/DIV ... 10 V/DIV are selected, reed relays K501 and K502 are activated, and the input signal is x100 attenuated by voltage divider R509 and R511.

The low impedance attenuator reduces the gain by x1, x2 and x5, using the voltage dividers R553, R551, R552, R554 and R556, selected by the FET switches inside D503.

For the various attenuation positions, the following FET switches are conductive:

Attenuation positions	FET switches conductive
x5	D503/9, 11, 12
x2.5	D503, 5, 6, 8
x1	D503/1, 3, 4

The AMPL/DIV switch S9 controls the FET switches via resistors R557, R559 and R562. These resistors have high-ohmic values to eliminate parasitic capacitance effects on the FET gates, thus preventing any loss of bandwidth. The trimmers C504 and C512 are adjustable to obtain constant input capacitance in all attenuator settings. The high-impedance attenuator sections are made independent of frequency (i.e. the capacitive attenuation for a.c. signals is adjusted to conform with the resistive attenuation for d.c. signals) by means of trimmers C503, C508 and C511.

Impedance converter (see Fig. 2.2. and 8.3.)

The input signal is fed via FET V501 (in source-follower configuration), transistors V503, V504 and V508 to the low-impedance attenuator.

The special type FET V501, with very fast rise-time response, reduces the source impedance which prevents bandwidth loss.

The FET consists of a double gate. One gate is not used and connected to the drain via R521.

The input signal is applied to the other gate.

The diodes inside this FET protect the input source follower of the impedance converter against excessive voltage swings.

The l.f. part of the signal is fed to the inverting input, pin 2, of D502 via the LF gain potentiometer R538. This l.f. signal is compared with a d.c. voltage on pin 3 of D502 that is adjustable with R547 (attenuator balance).

The output of D502 (frequencies up to 300 Hz, determined by R539 and C527) is routed to the voltage divider R543, R518.

The input signal of the impedance converter is fed to the other end of the voltage divider. The average value of both signals is fed to the inverting input of the correction amplifier D501. To reduce distortion originated in the current source V507, transistor V506 is mounted between the low-ohmic output of D501 and the base of V507.

The collector of V506 is high-ohmic, so the distortion on the base and on the emitter of V507 is equal and is eliminated.

If the feedback l.f. signal is, for example, too small, the correction amplifier will drive transistor V507 so that the amplitude of the l.f. part of the input signal is compensated.

Potentiometer R538 permits adjustment of the l.f. feedback gain. The d.c. offset of the operational amplifiers D502, D501 can be compensated by preset R547 (A, ATT. BAL.).

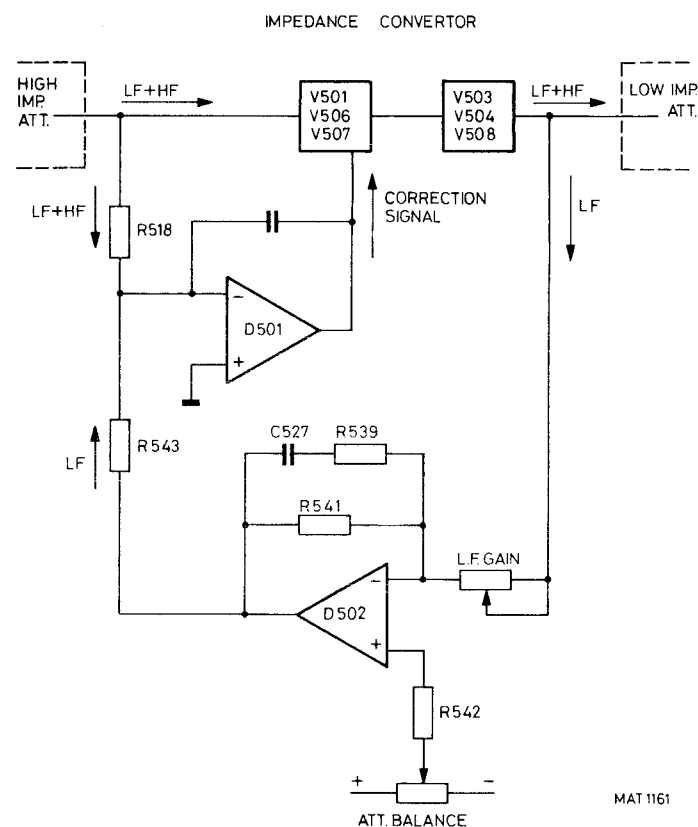

Fig. 2.2. Impedance converter

Continuous Control Circuit (see Fig. 2.3. and 8.3.)

The output signal of the low-impedance attenuator is fed to the integrated circuit D504 (3.6) via the continuous circuit comprising FET D503 (13, 14, 16).

This FET is located between the signal path, pin 6 of D504 and earth, via resistor R584. This resistor compensates the output impedance of the low-impedance attenuator (50Ω) and the impedance of the selected FET switch (30Ω), as shown in Fig. 2.3.

This compensation is necessary to obtain an equal bias current for the inputs (6,3) of integrated circuit D504. The continuous control R7 drives the FET (pin 14) more, or less conductive via transistor V519 and resistors R567, R566 and R568.

In the CAL position of the CONT. control R7, the FET drain-source junction (pin 13 and 16) is at a high ohmic level and thus the signal is not attenuated.

The CONT. control R7 is connected between +5 V and transistor V722, which functions as a voltage source. This also supplies the CONT. control (R8) of channel B.

If R7 is not in the CAL position, the current I increases (Fig. 2.3.). This increased the gate-source voltage of the FET, which results in a low drain-source resistance. The lower drain-source resistance reduces the amplitude of the signal fed to pin 6 of integrated circuit D504.

The CAL position of the CONT. control can be adjusted with the CAL CONT. potentiometer R622 that controls the current I through transistor V521. The CONT. control range can be adjusted with potentiometer R619.

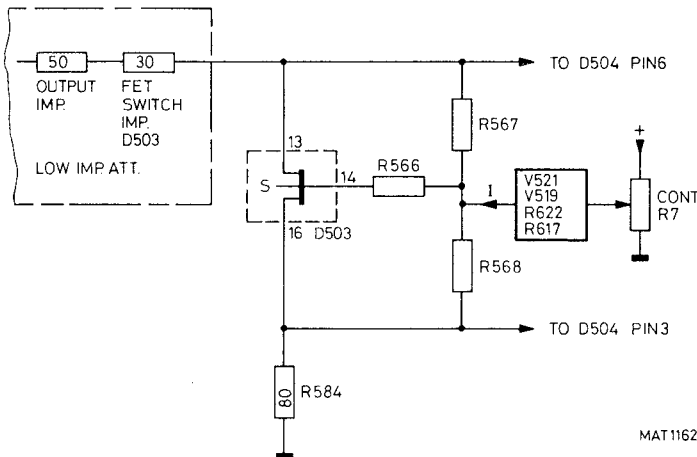

Fig. 2.3. Continuous control circuit

2.2.3. Amplifier

The channel A trigger signals for both time-bases are picked-off from pins 14 and 15 of integrated circuit D504. The circuit of D504 (known as a Cherry-stage) converts the voltage input signal into a current output signal (pins 12 and 13). Transistor V509 serves as a current source for D504.

In the three most sensitive AMPL/DIV positions (2,5, 10 mV/DIV) the amplifier has a gain of ten, controlled via D504, pin 2, from the AMPL/DIV switch.

Potentiometer R571 controls the current source circuit to give adjustment of the x1/x10 gain balance.

The x10 gain of the amplifier in the AMPL/DIV positions 2,5, 10 mV/DIV can be adjusted by potentiometer R586.

The supply voltage of D504 is applied to pin 9 via transistor V513.

In this way the temperature drift in the x10 gain mode is compensated to prevent bandwidth loss.

The gain x1 of channel B can be adjusted by potentiometer R779 to equalise the x1 gain of both vertical channels.

From the amplifier D504 (pins 12 and 13) the output current signal is routed to the vertical channel switch via transistors V516 and V517. These transistors function as a current mirror and also compensate for trace shift when the signal is inverted (POSITION control pulled). Potentiometer R604 (NORMAL/INVERT BAL) provides the shift compensation.

2.2.4. Vertical channel selection logic

VERTICAL DISPLAY MODE SWITCH S1	X501						D634				A	B	TRIG
	B4	A1	A3	A4	B2	A2	P5	P6	P7	P9	P8	P11	P3
A	*	*	0	1	0	1	1	0	0	1	1	0	0
B	0	1	1	0	0	1	0	1	0	1	0	1	0
TRIG VIEW	1	0	1	0	0	1	0	1	1	0	0	0	1
CHOP	0	1	1	1	1	1	1→0 0→1	0→1 1→0	0	1	1→0 0→1	0→1 1→1	0
ALT	0	1	1	1	0	0	1→0 0→1	0→1 1→0	0	1	1→0 0→1	0→1 1→0	0
ADD	0	1	0	0	0	1	1	1	0	1	1	1	0
CHOP + TRIG VIEW	1	1	1	1	1	1	1 0 0	0 1 1	1 1 0	0 0 1	1 0 0	0 0 1	0 1 0
ALT + TRIG VIEW	1	1	1	1	0	0	1 0 0	0 1 1	1 1 0	0 0 1	1 0 0	0 0 1	0 1 0

* = don't care
 1 = vertical channel is selected

Fig. 2.4. Vertical channel selection logic

The vertical channel switches D831 and D631 are controlled by the vertical channel selection logic (D632, D634, D633) which, in turn, is controlled by the vertical display mode switches: A, ALT, TRIG VIEW, CHOP, ADD, B.

These switches control the vertical logic via connectors X204 (on SWITCH UNIT A102) and X501.

Positive logic is used in the digital circuits; i.e. '1' is +5 V (H) and logic '0' is 0 V (L).

The table, Fig. 2.4., indicates the logic used for vertical mode selection.

Selection of the various vertical display mode pushbuttons has the following result:

A depressed: Pin 8 of D632 is H in this mode, opening the signal path for channel A in integrated circuit D631.
Signals on D631 pins 5 and 6 are routed to output pin 13, 14.

B depressed: Pin 11 of D632 is at H level in this mode, opening the signal path for channel B in integrated circuit D631.
Signals on D631 pins 3 and 4 are routed to the output (pins 13, 14).

TRIG VIEW

depressed: Pin 3 of D632 is H in this mode, opening the path for trigger view signals in integrated circuit D831.
The trigger view signal from the INTERFACE of the trigger amplifier (V861, V862) is routed to D831, pins 5 and 6, via transistors V831, V832.
In this mode, the TRIG VIEW signal is fed to the DELAY LINE DRIVER via the outputs (13, 14) of D831.

CHOP depressed: Pins 8 and 11 of D632 are alternately H and L at a fixed frequency of 500 kHz approx., generated by the chopper oscillator, consisting of transistor V632 and two NAND gates of D633 (11, 12, 13) (4, 5, 6) and capacitor C643.
If D632-6 is at H level, transistor V631 starts the chopper oscillator. Transistor V632 is blocked and C632 charges via R653.
If pins 12 and 13 of D633 are both H, its output goes to an L level, giving an H on pin 6 of D633. This H signal is fed back to the base of V632, which conducts and discharges C643 to give an L on D633-12.
Pin 6 of D633 goes L and blocks transistor V632, etc.
The chopper signal is applied to the clock inputs of the flip-flops D634 via D633, pins 10 and 8. The alternate pulse applied at D633-9 is overruled.
The J and K inputs (pins 2 and 3) and the preset and clear inputs (pins 4 and 15) of D634 are at level H, so this flip-flop switches on the chopper frequency applied to the clock input.
The input pin 10 of D634 is L and pin 14 is H, so output pin 7 is L in this mode, resulting in a level L on D632-3 (TRIG VIEW is off).

ALT depressed: In the ALT mode, the chopper oscillator is switched off (D632-6 = L).
However, D633-10 is H, which means that the alternate pulses from the HORIZONTAL CHANNEL SELECTION LOGIC are applied to the clock inputs of flip-flops D634 (pins 1 and 13), which make the D632 outputs (pins 8 and 11) alternately H and L.

ADD depressed: With ADD selected, D632 outputs 8 and 11 are both at H level.
Channel A and B signals are selected via pins 10 and 11 of D631, and are added in integrated circuit D631.

CHOP+TRIG VIEW

depressed: Vertical channels A, B and TRIG VIEW are displayed, the switching between these channels is being determined by the chopper oscillator. The chopper frequency is applied to the clock inputs of flip-flops D634 (pins 1 and 13).
The outputs of D832 (pins 8, 11, 3) are alternately H and L, controlled by the clock frequency (see Fig. 2.4.).

The display sequence is as follows:

Channel A
TRIG VIEW
Channel B

ALT+TRIG VIEW

depressed

Vertical channels A, B and TRIG VIEW are displayed, and in this mode the chopper oscillator is switched off, so D633-10 is at level H.

The alternate pulses are applied to the clock inputs of flip-flop D634, which control the switching between the three vertical channels. The display sequence is as follows:

Channel A
TRIG VIEW
Channel B

2.2.5. Vertical Channel Switch

The VERTICAL CHANNEL SWITCH consists of the two integrated circuits D831 and D631 (0Q0020), this IC being specially designed for application in vertical deflection systems.

This IC enables the following functions:

- Two differential input signals can be chopped (CHOP).
- One or two differential input signals can be selected (A and/or B).
- Two differential input signals can be added (ADD).
- Normal/invert mode is available per channel (PULL TO INVERT).
- Vertical Y shift is available per channel (POSITION).

The 0Q0020 is controlled by the outputs of D632 (pins 8, 11, 3) as follows:

0Q0020 pins		OUTPUT pins
10	11	13 and 14
0	0	NO
1	0	A
0	1	B
1	1	A + B

The normal/invert function is controlled by the PULL TO INVERT switches S4 and S5 via pins 7 and 2 of D631. If these inputs (7,2) are at level L the signal is inverted.

The vertical Y shift is controlled by the POSITION controls R1 and R2.

The variable voltages derived from the sliders of these controls are applied to pin 8 (channel A) and pin 1 (channel B).

The TRIG VIEW signal is derived from the INTERFACE of the MTB trigger amplifier and applied to D831 (pins 5 and 6) via transistors V831, V832, which adapt the trigger view signal to the input level of the channel switch D831.

The balance of the symmetrical TRIG VIEW signal is adjustable with R841. The trigger view signal is controlled by the signal applied to D831.

If this input is H, it opens the trigger view signal path to the DELAY LINE DRIVER.

2.2.6. Delay-line driver

The delay-line driver consists of the Hooper stage V633/V634 and Cherry stage V636/V637. The Hooper stage has an additional compensation circuit with operational amplifier D636. One input of D636 measures the emitter voltage of V633/V634; the other input is connected to a reference voltage derived from voltage divider R692/R693. In the event of voltage differences between both inputs, the output of D636 compensates for this via R662/R663 to the bases of V663 and V664. As a result, under no signal conditions, the collector voltages of V633 and V634 are constantly held at 9 V. This is necessary in order to obtain equivalent dynamic ranges for both halves of the amplifier stage.

The Cherry stage V636/V637 output is applied to the delay line (Unit 8). The output impedance of this stage matches the impedance of the delay line.

A signal used for composite triggering is picked off from the collectors of V 633 and V634 by Cherry stage V833/V834.

2.2.7. Final vertical amplifier

The signal from the delay line (Unit 8) is terminated by the delay line compensation circuit consisting of Cherry stage V1204/V1206 together with the common-current source V1203. The emitter circuit of V1204/V1206 comprises a number of square-wave signal adjustments, one of them formed by two varicapdiodes V1208 and V1207. Their capacitance value is determined by a d.c. voltage originating from NTC-resistor R1228. In this way, the amplifier is compensated for a decrease of rise-time in the event of higher ambient temperature. The Cherry stage V1204/V1206 is followed by a Hooper stage V1209/V1211. This stage also receives the trace separation control signal that gives a vertical shift between the main and delayed time-base displays in the alternate time-base mode.

The Hooper stage is followed by another Cherry stage V1213/V1214 with common-current source V1212. This stage incorporates a gain adjustment preset R1256 and a square-wave adjustment C1224. The Cherry stage drives output amplifier IC, D1201. The collector load resistors of the output amplifier are part of IC D1202. The vertical deflection plates of the CRT are driven by the output amplifier via coils D1203 and D1204. These coils form a resonant circuit together with the capacitive deflection plates of the CRT that results in an increase at the high frequency end of the bandwidth of the oscilloscope.

2.3. CIRCUIT DESCRIPTION OF THE HORIZONTAL SECTION

2.3.1. Main Time-base Triggering (see Fig. 8.5.)

a) Trigger selection circuit and trigger input stage (A, B, COMP)

The trigger signal from the vertical channel A is applied to shunt feedback amplifier V912, V913, as a symmetrical current signal. The output is a symmetrical voltage signal that is routed to the series feedback stage V873, V876 for MTB triggering, and to series feedback stage V872, V874 for DTB triggering. Channel A is selected as MTB trigger source if R918 in the emitter circuit of V873, V876 is connected to earth via the MTB trigger source selector switch S23, to switch on these transistors.

The trigger signal from vertical channel B is applied to shunt feedback amplifier V914, V916, which is followed by a series feedback stage V878, V879, for MTB triggering and a series feedback stage V877, V881 for DTB triggering. These amplifier stages are identical to those described above for channel A.

The composite trigger signal obtained from V833 and V834 in the delay line driver is applied to shunt feedback amplifier V917, V918.

This amplifier is followed by a series feedback stage, V882, V883 for MTB triggering. If R892 in the emitter circuit of V882, V883 is connected to earth via the MTB trigger source switch S23 via switching transistor V870, the composite signal is used for MTB triggering.

If in composite trigger mode TRIG VIEW is selected, a logic H level from D634-10 makes V880 conductive via R994 and V870 is switched off. Consequently, composite triggering is inhibited. In this event, V875 is conductive and an earth potential is applied to R918 via V860 to select channel A as MTB trigger source. As a result, it is not possible to switch on the trigger view and composite trigger modes together.

b) External and line trigger input

The external trigger signal can be applied to input socket X5. The signal is routed via a network that gives the correct external input impedance and sensitivity, and via C1109 (a.c.-component), R1122, R1123 (d.c.-component) to the gate of FET V1104. In the LF and HF trigger coupling modes the d.c. component of the signal is interrupted because the junction of R1122, R1123 is connected to earth via LF and HF switches S20.

FET V1104 is part of the balanced source-follower stage. One FET receives the external trigger signal and the other, the LINE trigger signal. The trigger source signal not desired is short-circuited to earth.

The LINE trigger signal, originated in the power supply, is routed via the potentiometer R891 (LINE) to the TRIGGER SELECTION UNIT.

The amplifier stage V1104 is followed by a series feedback stage V1102, V1103 that converts the asymmetrical input voltage signal into a symmetrical output current signal.

Transistor V1101 provides a common current-source in the emitter circuit, which is only switched in if EXT or LINE triggering is selected (an earth potential from trigger source selector switch S23).

For instruments with TTL trigger facilities (optional), the gain of the amplifier stage V1102, V1103 can be increased by a factor of 2.5 (relay contact K1101 closes in the TTL trigger mode).

c) Trigger amplifier input stage

This amplifier has two balanced inputs that apply an input signal to the common-base circuit V852, V853. The input current is routed via socket X859 and socket X863 for MTB triggering via channel A, B or composite. The input current signal is routed via sockets X861 and X862 for MTB triggering via the EXT input or LINE.

The common-base circuit V852, V853 is followed by a shunt feedback stage V851, V854 that converts the input current signal into an output voltage signal. This output signal is taken off asymmetrically and applied to the DC, LF, HF filter.

d) Trigger coupling

In the DC mode, relay contact K851 is closed and the signal is passed unattenuated via R868.

In the LF mode, K851 is open and switch contact S20C is closed. The signal is now passed via the series low-pass filter R872, C858, R869.

In the HF mode, K851 is open and switch contact S20D is closed (moving contact to earth). The signal is now passed via the high-pass filter C858, R872. Both in LF and HF modes, the d.c. component is blocked by C868.

In the AUTO mode, the trigger signal is a.c.-coupled (K851 is open).

Only in the external X deflection mode together with AUTO mode can d.c. coupling be selected.

If TTL trigger mode is available on the instrument, the signal is always d.c.-coupled (K851 closed).

e) Interface

This stage receives its input signal from the DC, LF, HF trigger coupling and produces asymmetrical output signals for the TOP DETECTOR, TV CIRCUIT and X DEFLECTION AMPLIFIER.

The INTERFACE also produces symmetrical output signals for TRIGGER VIEW and the FINAL TRIGGER AMPLIFIER.

The asymmetrical voltage signal from the TRIGGER COUPLING stage is applied to one gate of the symmetrical FET source-follower stage V887. The other gate of V887 receives a d.c. voltage that can be adjusted with the LEVEL control R6. As a result, the source outputs of V887 show a symmetrical voltage signal, the level of which can be varied by the LEVEL control.

The source-follower V887 is followed by an emitter-follower D853 (9,10,11) (6,7,8) with a common-current source V859. As the emitter-follower transistors are part of one IC, it results in better stability and closer-matched characteristics for these transistors. This technique is featured widely in the MTB and DTB trigger circuits.

An asymmetrical current signal for external X deflection is picked-off from D853-11 and routed via the switch unit to the horizontal channel switch on the time-base unit.

Another asymmetrical current signal is taken from D853-6 and is routed via shunt feedback amplifier V863 to the TOP DETECTOR and the TV CIRCUIT.

The symmetrical output voltage signal is available on D853-10 and D853-7, and applied to series feedback stage V862, V861, with common current source V864. This stage sends a symmetrical current signal to the vertical channel switch to facilitate trigger view.

f) Final trigger amplifier

The signal available on D853-10 and D853-7 is also applied to the series feedback amplifier D853 (12,13,14) and D853 (1,15,16). The common current source for this stage is D853 (2,3,4), switched on by an earth potential applied to R996 via selection switch S20A. In the external X deflection and TV trigger modes this is switched off and R996 floats.

In the TTL trigger mode (optional) the amplification of this stage is increased as relay contact K852 closes.

The symmetrical output current signals are available on D853-12 and D853-1 and have phase shift of 180 degrees.

Depending on the position of the +/- SLOPE switch S8, one of the two signals is used for MTB triggering.

Selection is by switching diodes: V888, V889 for the + slope, V857, V858 for the - slope.

If the + slope is selected (S8 open), V889 blocks and the signal from D853-12 is routed via V888 to the MTB.

Transistor V896 is not conducting so transistor V897 switches on. The positive potential on its emitter switches on diode V857 and the signal from D853-1 leaks away. Diode V858 is blocked and the connection between D853-1 and the MTB is interrupted.

If the - slope is selected (S8 closed), V889 conducts, so the signal from D853-12 leaks away. Diode V888 blocks so any signal at this point is also prevented from reaching the MTB.

In this event, transistor V896 conducts because the positive-going base potential and switches off transistor V897. Diode V857 blocks as a result, so diode V858 conducts and the output signal on D853-1 collector is routed to the input of the MTB.

g) TV circuit

With the TV CIRCUIT it is possible to trigger the MTB on television line signals (TIME/DIV = 20 μ s... 0,05 μ s/DIV) or TV frame signals (TIME/DIV = 0,5 s...50 μ s/DIV).

In the TV mode, the FINAL TRIGGER AMPLIFIER is inoperative and instead, the TV CIRCUIT triggers the MTB. The LEVEL control R6 is also inoperative and the +/- slope switch S8 permits selection between positive and negative video signals.

The input of the TV circuit is the base of transistor V869. For positive video signals V869 functions as an amplifier with a phase shift of 180 degrees between base and collector. In this mode, collector resistor R983 is connected to +14 V via transistor V897, which is conducting.

For negative video signals, V896 functions as an emitter-follower. As a result, there is no phase shift between base and collector. This collector now functions as an emitter, connected to -7 V via R1011 and R983. In this situation, transistor V897 is not conducting. The collector of V869 is direct-coupled to the base of emitter-follower V871. This is followed by a clamping stage formed by C904 and the base-emitter junction of V899, the synchronisation pulses being available on its collector. These pulses have a top level of +5 V and a bottom level of 0 V approx. In the TV line trigger mode, the pulses are routed via diode V901, transistor V898 and switching diode V894 to the MTB trigger circuit.

In the TV frame trigger mode (MTB TIME/DIV = 0,5 s...50 μ s/DIV), switching transistor V909 conducts via the TIME/DIV switch. As a result, C917 and C918 are switched into the circuit and line trigger pulses are suppressed.

Only frame trigger pulses can now reach the MTB trigger circuit.

Transistor V908 functions as a 'current mirror' in order to give the correct current ratio between the current in the diode V894 and in transistor V898.

The TV CIRCUIT is switched off by a 0 V applied to the cathode of diode V901.

h) Multiplexer

This circuit stage produces the supply voltage for the MTB LEVEL control R6. The integrated circuit multiplexer D851 contains two 4-way analog switches that select the voltages applied to both ends of the LEVEL control. These voltages depend on the selected trigger mode.

The four possible modes are:

- TV (TTL, ECL) mode
- AUTO (peak-peak level mode)
- TRIG mode
- EXT X DEFL mode

Switch position depends on the logic levels at control inputs pins 10 and 9 of multiplexer D851.

In the TV (TTL, ECL) mode, the control input D851-10 is at logic L and input D851-9 is also L.

Thus, inside the multiplexer points 1+3 are interconnected and also points 12+13.

As a result, the potential from voltage divider R907, R909 is connected to both ends of R6. The position of R6 is now irrelevant and the trigger level is fixed.

Note that circuit differences necessary to adapt the instrument from TV into TTL, ECL triggering are indicated in the table given in the circuit diagram.

In the AUTO mode, the control input D851-10 is at logic H and D851-9 is L. Internally, multiplexer points 2+3 and points 15+13 are interconnected. This results in one end of R6 being connected to D852-1 output, which carries a voltage proportional to the top level of the trigger signal. The other end of R6 is connected to output D852-7. This operational amplifier output carries a voltage that is proportional to the bottom level of the trigger signal. In this mode the MTB stays triggered in all positions of the LEVEL control since the voltage on R6 is proportional to the signal voltage.

In the TRIG mode, the control input D851-10 is at logic H, D851-9 is H and internally, points 4+3 and points 11+13 are interconnected. As a result, one end of R6 is connected to -3 V approx. from voltage divider R884, R903, and the other end of R6 is connected to +3 V approx. from voltage divider R951, R952.

The MTB trigger level can now be adjusted over approximately +8 or -8 divisions of the displayed signal.

In the modes described above, transistor V866 conducts and D851-6 is at logic L; as a result, the multiplexer input levels are applied to output pins 3 and 13. In the EXT X DEFLECTION mode however, transistor V866 blocks and D851-6 is at logic H. In this case, the multiplexer input levels are isolated from the outputs, which now float.

i) Top detector

This stage produces positive and negative output d.c. voltages that are proportional to the positive and negative top of the trigger signal. In the AUTO mode, these voltages are applied to the two ends of the LEVEL control R6. The input signal for the TOP DETECTOR is derived from shunt feedback stage V863. The positive top of this signal is rectified by diode V867 and smoothed by C872. The negative top is rectified by diode V868 and smoothed by C873.

Both voltages are applied to the non-inverting input of an operational amplifier D852 (inputs 3 and 5). The feedback loop of each amplifier is such that the gain is one. These operational amplifiers operate as emitter-followers with a high input impedance and a low output impedance.

2.3.2. Delayed Time-base Triggering (see Fig. 8.6.)

a) Trigger selection circuit (A, B)

Series feedback amplifier V872, V874 receives the channel A signal for DTB triggering. Channel A is selected as a DTB trigger source if R886 in the emitter circuit of V872, V874 is connected to earth via the DTB trigger source switch contacts S22A to make this stage conductive.

Series feedback amplifier V865, V895 receives the channel B signal for DTB triggering if R888 in the emitter circuit of V865, V895 is connected to earth via switch contacts S22B of the trigger source switch, which makes this stage conductive.

b) Trigger amplifier input stage

This is a balanced input amplifier that accepts input current signals via sockets X871 and X872 when triggering the DTB via channel A or B. The common-base circuit V921, V922 is followed by a shunt feedback stage V923, V924 that converts the input current signal into an output voltage signal.

This output signal is taken off asymmetrically from V923 collector and applied to the DC, LF, HF filter.

c) Trigger coupling (DC, LF, HF)

In the DC mode, switch contact S19A is closed and the trigger signal is passed via R1080 without frequency attenuation.

In the LF mode, the d.c. path is interrupted and switch contact S19B is closed. The signal is now passed via the low-pass filter R1057, C929.

In the HF mode, the d.c. path is interrupted and switch contact S19C is now closed. The signal is passed via the high-pass filter C929, R1057. Both in the LF and HF modes, the d.c. component is blocked by the series capacitor C931.

d) Final trigger amplifier

The asymmetrical voltage signal from the TRIGGER COUPLING stage is applied to one gate of the symmetrical FET source-follower stage V919. The other gate receives a d.c. voltage, adjustable by the LEVEL control R4. As a result, the source outputs of V919 show a symmetrical voltage signal, the d.c. level of which is adjustable by R4. This signal is fed to an emitter-follower stage D854 (9,10,11) and D854 (6,7,8), part of integrated circuit D854. The symmetrical output voltage signal on emitters D854-10 and D854-7 is applied to the series feedback amplifier D854 (12,13,14) and D854 (2,3,4), with common-current source D854 (1,15,16).

The symmetrical output current signals are available on collectors D854-12 and D854-2 and have a phase shift of 180 degrees. Depending on the position of the SLOPE switch S6, one of the two signals is selected for DTB triggering by means of switching diodes: V910, V906 for + slope, V892, V891 for - slope.

If the + SLOPE is selected (S6 open), V906 is not conducting and the signal from collector D854-12 is routed via diode V910 to the DTB.

Transistor V907 is not conducting and transistor V893 is therefore switched on. Diode V892 is blocked and the connection between collector D854-2 and the DTB is interrupted.

If the - SLOPE is selected (S6 closed), diode V906 now conducts, so the signal from collector D854-12 leaks away. Furthermore, diode V910 blocks and prevents any signal from collector D854-12 being passed to the DTB. The positive voltage applied to the base of V907 from S6 causes this transistor to conduct, which then turns off transistor V893. As a result, diode V891 is blocked and the output signal on collector D854-2 is routed via V892 to the input of the DTB.

2.3.3. Main Time-base (see Fig. 8.9)

For a fuller understanding of the functioning of the main time-base, important voltage waveforms in the MTB control logic are given in Fig. 2.5.

a) Auto mode without triggering (free-running time-base)

Consider the situation at the moment the main time-base starts.

With AUTO selected (S3A closed), NOR-gate output D209-13 is L and the switching transistors V233 and V234 are turned off. The MTB is therefore able to run and produces a time-linear sawtooth voltage. This is picked-off by the Darlington pair V257, V258 and applied to the X deflection selector via emitter-follower V224 and switching diode V217.

b) Main time-base generator

The MTB is based upon the principle that a timing capacitance charged by a constant-current source is capable of generating a time-linear sawtooth voltage that is ideal for c.r.t. forward trace sweep and flyback.

Transistor V236 provides the current source, the base of which is connected to a fixed voltage in the CAL position of R10. This voltage is only varied when the continuous control R10 is moved from the CAL position. The emitter resistance of V236 may have ten different values (R109...R113) selectable by the TIME/DIV switch S15, which has 22 positions. Three timing capacitors are also selectable. Capacitor C226 is permanently in circuit, capacitor C234 is selectable via switching transistor V238 and C241, C242 and C243 paralleled capacitance via transistor V237. These transistors function in 'reversed' mode (collector-emitter reversed) during charging of the timing capacitors and in the 'normal' way during the discharge period.

The following table indicates the capacitors and adjustment potentiometers that are brought into circuit in the various positions of S15.

TIME/DIV range	Timing capacitors in circuit	Adjustment point
0,05 μ s ... 5 μ s/DIV	C226	—
10 μ s ... 2 ms/DIV	C234 (via V238) (+C226)	R348
5 ms ... 0,5 s/DIV	C241, C242, C243 (via V237) (+C226)	R347

The MTB sawtooth voltage is also routed via voltage divider R327, R329 and emitter-follower V256 to the input of Schmitt trigger D214 (1,2,3), the end-of-sweep detector. It detects an H input level if the input voltage rises above +1,9 V, whereupon output D214-3 becomes L. This L level is applied to the set input, pin 4 of flip-flop D212, to make the inverting output (pin 6) logic L.

This L level is routed via NAND gate D211 (3,4,5,6) and NOR gate D209 (2,3,1) to input pin 12 of D209. Input pin 2 is always at logic L in the AUTO mode. If no trigger signal is present, the other input, pin 11 of D209 is permanently at L. The L level on input D209-12 makes output D209-13 go to level H, which makes transistors V233 and V234 conductive. Switching transistor V233 discharges the MTB timing capacitance and V234 takes over the current from current source V236. As a result, the MTB sweep is switched off.

The L level from the inverting output pin 6 of flip-flop D212 is applied to the base of switching transistor V271, to switch it off. The hold-off time now starts.

c) Hold-off circuit

The hold-off time-base circuit operates according to the same principle as for the MTB and DTB. Timing capacitors are charged by a constant-current source to generate a time-linear sawtooth voltage. The charging current can be adjusted in steps via the MTB TIME/DIV switch, which influences the voltage applied to the non-inverting input (pin 3) of operational amplifier D216. The HOLD-OFF potentiometer R11 permits continuous adjustment of the current.

The voltage on the hold-off timing capacitors is applied to the input of Schmitt trigger D214 (12,13,11) via Darlington pair V286, V272 and the voltage divider R339, R308.

If this voltage has reached a level of +1,9 V, an H level is detected. In this event, output D214-11 becomes L. This L level is applied to the reset input D212-1, which gives an H on inverting output pin 6. Switching transistor V271 conducts again and the hold-off time-base is switched off: the timing capacitance is discharge.

Schmitt output D214-11 and NAND gate input D211-3 are at level H when the hold-off capacitors are discharged. The H level on output pin 6 of flip-flop D212 is routed via D211 (3,4,5,6) and D209 (2,3,1) to D209-12 input and the time-base restarts.

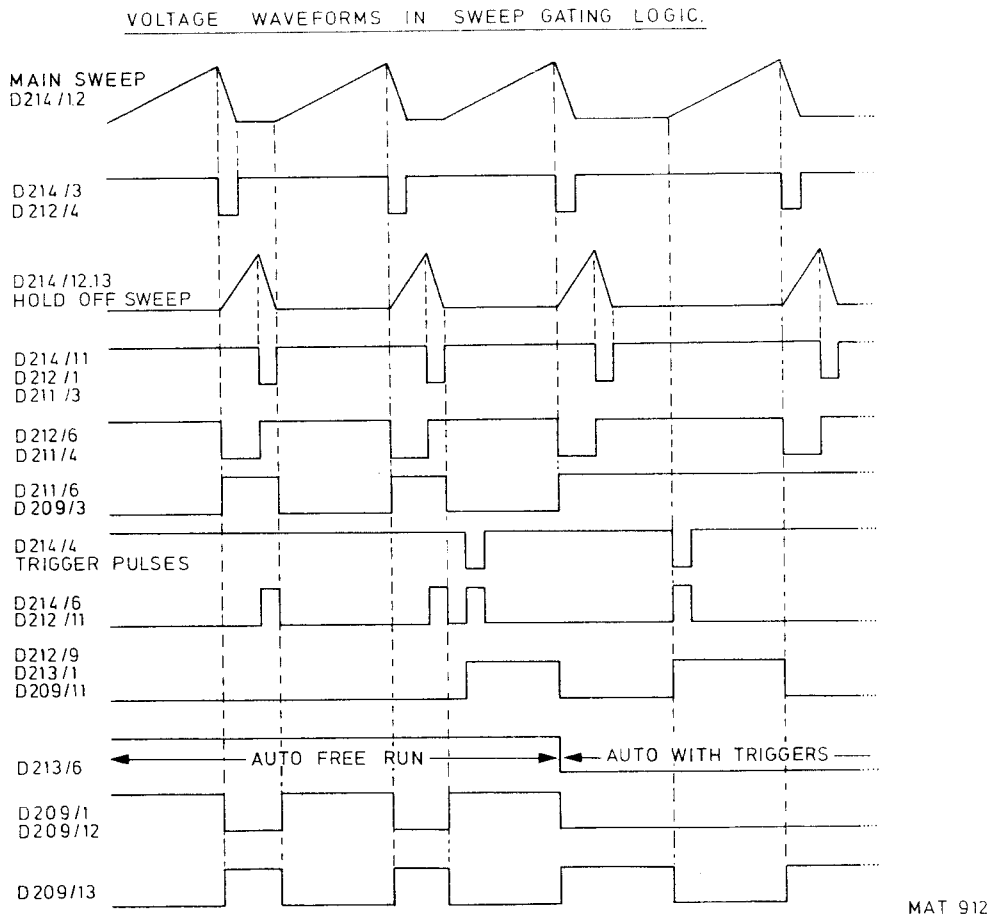

Fig. 2.5. Important voltage waveforms in the MTB control logic

d) AUTO mode with trigger pulses

MTB trigger pulses are applied as a current signal to the CURRENT-VOLTAGE CONVERTER. If a trigger pulse occurs in this mode, transistors V291 and V292 convert the selected trigger source current signal into a voltage signal, and emitter-follower V293 makes D214-4 input logic L. This trigger pulse is applied at H level to clock input pin 11 of flip-flop D212, which switches over to make output pin 9 logic H. This cannot occur during the hold-off period because D214-5 is L, or reset input D212-13 is L.

The H level from D212-9 output switches off transistor V233 and diode V234 via NOR gate D209 (11,12,13) to start the time-base.

As described for the free-run mode, the end of the time-base sweep is detected and the hold-off time-base is started.

When this occurs, output pin 6 of flip-flop D212 becomes L. This L level is routed via NAND gate D211 (1,2,13,12) and NOR gate D209 (8,9,10) to the reset input (13) of flip-flop D212. As a result, output pin 9 does L and the time-base is switched off. Moreover, the one-shot multivibrator D213 is triggered and output D213-6 stays at level L for 100 ms after the H to L transition of the clock input on pin 1.

If D213-6 is L, then D211-5 is also L. This means that it is not possible to start the time-base at the end of the hold-off period via the path D211 (3,4,5,6) and D209 (2,3,1). Now the MTB can only be started if a trigger pulse appears. An incoming trigger pulse is applied to the clock input (11) of flip-flop D212 to make output pin 9 logic H. This H level is applied to pin 11 of NOR gate D209, which makes output pin 13 a logic L and the MTB starts.

e) Triggered mode (see also AUTO mode with and without triggering)

In the triggered mode, the signal path that starts the MTB directly after the hold-off period (in auto free-run mode) is interrupted by an H level on NAND gate D209-2. This interrupted signal path is via D211 (3,4,5,6) and D209 (2,3,1).

The finish of the MTB sweep at the start of the hold-off period is identical to the situation described for AUTO mode. At the start of the hold-off period, input pin 2 of NAND gate D211 becomes L. As inputs 1 and 13 are both H, output pin 12 becomes H. This produces via NOR gate D209 (8,9,10) a logic L that is applied to reset input (13) of flip-flop D212. Consequently, the flip-flop switches over and the MTB stops.

f) SINGLE-SHOT mode (see also AUTO and TRIGGERED modes)

In this mode, the conditions of the Set-Reset (SR) flip-flop formed by NAND gates D211 (1,2,12,13) and D211 (8,9,10,11) are important.

Before the start of the hold-off period, the following apply:

D211 INPUTS	LEVEL		OUTPUTS	
2 1 13	H H H	only L in EXT X DEFL	12	L
11 9 10	L H H	only L in AUTO and TRIG	8	H

At the start of the hold-off period input pin 2 of D211 is made L and the flip-flop jumps to the set position (output 12 is H, output 8 is L).

This situation remains after the end of the hold-off period although input 2 is now H, because an L level from output 8 is applied to input 13 of D211. As a result of this SR flip-flop condition, the reset input pin 13 of flip-flop D212 stays at L and the time-base cannot be started by a further trigger pulse.

Only by forcing the SR flip-flop back to the reset condition (output 12 at L, output 8 at H) is it possible to re-trigger the time-base. Reset is achieved if the SINGLE/RESET pushbutton is depressed, to give an L level to input 10 of the SR flip-flop. However, the time-base can only be triggered if the SINGLE/RESET pushbutton is in the normal position. If it is depressed, the reset input (pin 13) of flip-flop D212 remains at level L via D214 (9,10,8) and D209 (8,9,10).

In the SINGLE mode, the signal path that starts the time-base directly after the hold-off period (in AUTO free-run mode) is interrupted by an H level on D209-2. This interrupted signal path is D211 (3,4,5,6) and D209 (2,3,1).

g) EXT X-DEFL mode

Input pin 1 of SR flipflop D211 is permanently at level L. Consequently, output D211-12 is H. This H level gives an L level on reset input pin 13 of D212, which inhibits the start of the time-base in this mode.

h) NOT TRIG'D indicator

The not triggered indicator, LED B1, is supplied with current from the current source V1512 on the FINAL AMPLIFIER UNIT A5 via X202-7.

If the time-base is running, flip-flop output D212-8 is L, this level being applied via diode V252 and via X202-7 to the anode of B1 to hold it off (see Fig. 8.12).

When trigger pulses occur with a time interval of 100 ms or less, pin 6 of one-shot multivibrator D213 is permanently at logic L. This L output is fed via diode V251 to the anode of B1 to switch it off.

In the SINGLE mode, the output 8 of flip-flop D211 is L from the start of the hold-off period until the moment when the SINGLE/RESET pushbutton is depressed. This L level is applied via diode V249 to the anode of B1 to hold it off.

The NOT TRIG'D indicator normally glows when awaiting a single-shot trigger.

i) HORIZONTAL CHANNEL SELECTION LOGIC & HORIZONTAL CHANNEL SWITCH

MTB only (S2D depressed or all horizontal display mode switches S2 released)

In this mode, S2D feeds a logic L to the set input (10) of flip-flop D207. The reset input (13) is H, therefore output pin 9 is H and inverting output pin 8 is L. This L level causes transistor V208 to conduct and thus opens a signal path for the MTB sweep via transistor V224 and the diode V217 to the input of the final X amplifier.

DTB only (S2B depressed)

In this mode, an L level is applied to the reset input pin 13 of D207. The set input (10) is H and inverting output pin 8 is H. The L output on pin 9 causes transistor V223 to conduct and thus opens the signal path for the DTB sweep via diodes V211 and V214 to the final X amplifier.

EXT X-DEFL only (S2A depressed)

In this mode, both the set input (10) and the reset input (13) of D207 are made logic L via diodes V294 and V295 and S2A-6 of the horizontal display mode switch. Consequently, outputs (pins 9 and 8) of flip-flop D207 are H and both the MTB and DTB sawtooths are prevented from reaching the input of the final X amplifier.

The external X deflection signal is now routed via transistors V203 and V204, in the X DEFLECTION AMPLIFIER, and switching diode V216 to the X FINAL AMPLIFIER.

ALT TB mode (S2C depressed)

Flip-flop D207 functions as a divide-by-two stage in this mode because the set and reset inputs are both at level H, and the data input (12) is connected to the inverting output (8). The signal applied to clock input (11) is the END OF SWEEP pulse. This signal goes L at the end of the MTB sweep and goes H when the MTB sweep reaches the 0 V level. When the clock-pulse input goes from L to H the condition of the flip-flop changes. For instance, output 9 goes H and the inverting output 8 goes L, so the MTB sawtooth is applied to the final X amplifier. After the L to H transition, on the clock input, output 9 is L and inverting output 8 is H, which applies the DTB sawtooth to the final X amplifier. At the next transition, the MTB is again applied, and so on.

j) Trace separation circuit

This stage is formed by integrated circuit D202, of which the transistors connected to pins 1, 15, 16 and 8, 9, 10 are not used (all pins wired to -7V). The TRACE SEPARATION CIRCUIT receives, via two outputs, current from R1238 and R1244 in the FINAL VERTICAL AMPLIFIER. These currents provide the trace shift in the ALT TB mode.

The transistor connected to pins 2 and 1, and the transistor connected to pins 7 and 8 are current sources.

If the ALT TB mode is not selected, the currents from both sources are equal because the switch contact S2C between pins 2 and 7 is closed. The output pin 1 of NOR gate D208 is at logic L. Therefore the current from R1244 is routed to D202-11 and via an internal transistor to the current source connected to pins 7, 8. The current from R1238 is routed to D202-14 and then via an internal transistor to the current source on pins 2, 1. When ALT TB mode is selected, the contact between pins 2 and 7 of D202 is open. Consequently, the current of both current sources is no longer equal. Current source pin 2, 1 carries a lower current than current source pin 7, 8. The difference depends on the setting of the TRACE SEPARATION potentiometer R15. With R15 at zero resistance both currents are identical. If the DTB is displayed, NOR gate output D208-1 is L and the routing of the currents of R1244 and R1238 over both current sources are identical to the situation without ALT TB selected. Only the magnitude of the currents differs, that from R1238 being higher than that from R1244. This results in a downwards shift of the time-base line in comparison with the situation where the currents in R1238 and R1244 are equal.

In the MTB sweep that follows, the MTB is displayed and the output D208-1 is now H. As a result, the currents from R1238 and R1244 in the FINAL VERTICAL AMPLIFIER are routed via another path in D202. The current from R1244 is routed to D202-12 and is lower than the current from R1238, which is routed to D202-13. In this case, the result is an upwards shift of the time-base line compared with the situation where the currents in R1238 and R1244 are equal.

k) Z-LOGIC

This stage sends a current signal to the Z amplifier to control the intensity of the spot on the c.r.t. screen. The spot intensity depends on the mode selected; e.g. MTB, MTB intensified by DTB, DTB, ALT TB, EXT X DEFL, and also on the position of the INTENS control R12.

During the hold-off period the display must be blanked. The current that determines the intensity is a summation of the collector currents of transistors V288 and V289. Both transistors are controlled by the logic circuits: V288 by NAND-gate output D218-12 and V289 by NAND-gate output D218-6.

If both logic outputs are L, V288 and V289 conduct and the display is unblanked. The logic levels on D218-12 and D218-6 as a function of the mode selected are given in Fig. 2.6.

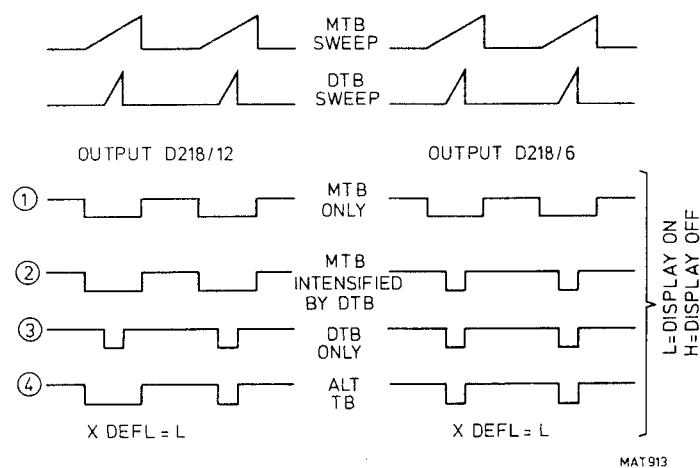

Fig. 2.6 Important voltage waveforms in the Z-modulation control logic

MTB only

During the MTB sweep, input D217-2 is H, resulting in OR-gate output D217-3 and D218-13 becoming H during the sweep.

Input D217-5 is H if the MTB output signal is routed to the final X amplifier. As a result, OR-gate output D217-6 is H during this time, and also D218-1.

NAND-gate input D218-2 is permanently H so output **D218-12 is L during the MTB sweep** (see Fig. 2.6/1 for comparison).

Input D217-12 is H during the MTB sweep, so OR-gate output D217-11 is H and also D218-5.

Input D217-9 is H. As a result for gate output D217-8 is H and also D218-4.

Input D218-3 is H. Output **D218-6 is L during the MTB sweep** (compare with Fig. 2.6/1).

DTB only

Input D217-4 is H during the DTB sweep, which makes output D217-6 and input D218-1 logic H.

Input D217-1 is H and consequently output D217-3 is H and also input D218-13.

Input D218-2 is permanently H, so output **D218-12 is L during the DTB sweep** (compare this with Fig. 2.6/3).

Input D217-10 is H during the DTB sweep, which makes output D217-8 and also input D218-4 at logic H during the DTB sweep.

Input D206-2 is L, so output D206-3 and also input D217-13 go to logic H. Consequently, the OR-gate output D217-11 and input D218-5 are at logic H.

Input D218-3 is permanently at H so output **D218-6 is L during the DTB sweep** (compare this with Fig. 2.6/3).

MTB intensified by DTB

When this mode is selected, the input of the FINAL HORIZONTAL AMPLIFIER is derived from the MTB output and the DTB TIME/DIV switch does not occupy the OFF position.

Input D217-2 is H during the MTB sweep, which means that D217-3 and input D218-13 are also H during the sweep period.

Input D217-5 is H if the MTB output signal is routed to the final X amplifier. As a result, OR-gate output D217-6 and input D218-1 are also H.

With input D218-1 also H, the output of this 3-input NAND gate **D218-12 is L during the MTB sweep** (compare this with Fig. 2.6/2).

Input D217-10 is H during the DTB sweep, which means that output D217-8 is H during the DTB sweep and also input D218-4.

A logic L on input D206-2 makes output D206-3 and also input D217-13 logic H. Output D217-11 is therefore H and also input D218-5.

Input D218-3 is H, so output **D218-6 is L during the DTB sweep** (compare this with Fig. 2.6/2).

Therefore with L signal on NAND-gate output D218-12 during the MTB sweep, transistor V288 conducts. With an L signal on NAND-gate output D218-6 during the DTB sweep, transistor V289 conducts, and during that time the current from the Z amplifier doubles providing that preset R401 is in mid-position. This increase in current produces the intensified part of the MTB trace during the DTB sweep.

ALT TB mode

When ALT TB is selected, NAND-gate output **D218-6 is L during the DTB sweep**, in the same way as described for the 'DTB only' mode (compare with Fig. 2.6/4 and Fig. 2.6/3).

For NAND-gate output **D218-12** this situation is as follows:

- for one MTB sweep, the output is **L during that MTB sweep**,
- for the next MTB sweep the output is **L during the DTB sweep**.

This depends on the condition of flip-flop D207 (8...13), which switches the final X amplifier input alternately between MTB (**D218-12 L during MTB sweep**) and DTB (**D218-12 L during DTB sweep**).

The generation of these pulses occurs as follows:

- If the MTB is used for X-deflection then D217-1 is L. Pin 2 is H during the MTB sweep, so D217-3 and D218-13 are also H during the MTB sweep.
Input D217-5 is also H, which makes output D217-6 a logic H.
Thus input D218-1 is H and since input D218-2 is H, the three inputs of the NAND-gate are at H, which gives a logic **L on output D218-12 during the MTB sweep** (compare with Fig. 2.6/4).
- If the DTB is used for X-deflection (the next MTB sweep) then D217-5 is L. Pin 4 is H during the DTB sweep, so D217-6 and D218-1 are also H during the DTB sweep.
Input D217-1 is H, which makes output D217-3 and input D218-13 logic H. As the remaining input, D218-2 is H, then the NAND-gate output **D218-12 is L during the DTB sweep** (compare with Fig. 2.6/4).
- At the next MTB sweep, the MTB is again selected for X-deflection and D218-12 is L during the MTB sweep, and so on.

Display Blanking

In the foregoing circuit descriptions for display blanking in MTB, MTB intensified DTB and ALT TB modes, it is assumed that inputs 2 and 3 of D218 are permanently at logic H. However, there are certain conditions, listed below, when these inputs are L and the display is blanked.

- In the chopped mode of the vertical channels the display is blanked during switching over between channels, by connecting the cathode of diode V296 to earth for this period.
- If a logic L is applied to the external Z MOD input on the rear-panel, this signal is routed via diode V297 to inputs 2 and 3 of D218 for blanking purposes.
- The display is blanked if an incorrect mode is selected. This condition is detected by NAND gates D218 (9,10,11,8) and D206 (4,5,6) which together give a logic L on the cathode of diode V298.

Inputs D218-9/10 are H if X DEFL is selected or if the DTB TIME/DIV switch is OFF (V285 non-conductive).

Input D218-11 is H if ALT TB is selected or if the final X amplifier is fed from the DTB signal. As a result, output D218-8 is L (i.e. display blanked), if DTB TIME/DIV switch is OFF while DTB or ALT TB selected on S2. The display is also blanked if X DEFL is selected together with DTB or ALT TB for horizontal display.

l) ALTERNATE mode control logic (see Fig. 2.7)

This circuit produces clock-pulses for the vertical display mode logic. It consists of NOR gates D208 (1,2,3), D208 (11,12,13), D208 (8,9,10) and NAND gate D206 (8,9,10).

The pulses are routed via the switch unit to UNIT 3.

The vertical display switches from one channel to the other if output D206-8 goes from L to H.

The circuit operates as follows:

If the horizontal deflection is initiated by MTB or DTB only, input D208-11 is L. Normally, input D208-12 is H, but is L during the flyback period of the MTB (= discharge of timing capacitance). If input D208-12 goes from H to L (at start of MTB flyback) this transition is routed via D208 (11,12,13), D208 (8,9,10) and D206 (8,9,10), this triple inversion making output D206-8 go from L to H to switch the vertical channel display from one to the other.

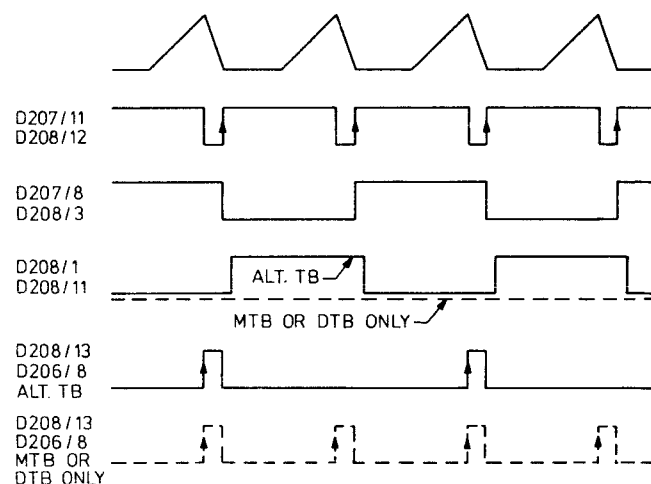

MAT 914

Fig. 2.7 Important voltage-waveforms in the alternate mode control logic

If the ALT TB mode is selected, input D208/12 also goes from H to L at the start of the MTB flyback period. Input D208/11 is H if the MTB drives the final X amplifier, and L if the DTB drives the final X amplifier. As a result, the H to L transition of input D208/12 only gives a L to H transition of output D206/8 if the DTB drives the final X amplifier.

Thus the display sequence in the ALT TB mode combined with ALTERNATE vertical display is:

- Channel A with MTB intensified by DTB
- Channel A with DTB
- Channel B with MTB intensified by DTB
- Channel B with DTB
- Channel A with MTB intensified by DTB, and so on.

m) Stabilisation circuit

This circuit consists of operational amplifier D201 and transistor V200. The circuit converts +14 V into +12 V for the time-base, and the current drain from +14 V is constant. The reference voltage for the positive input of D201 is obtained via voltage divider R201, R202 from the +14 V supply. The negative input of D201 is connected to the +12 V output voltage. Any variation between reference voltage and output voltage is corrected via output D201-6 and emitter-follower V200.

2.3.4. Delayed Time-base (see Fig. 8.11)

The DELAYED TIME-BASE GENERATOR itself generates a time-linear sawtooth in the same way as described for the main time-base.

Transistor V229 is the constant-current source, with its base fed from a fixed d.c. voltage that is derived via the continuous TIME/DIV control R9. The base voltage of V229 is only changed if R9 is moved out of the CAL position. By means of the TIME/DIV switch S13, eight different emitter resistors can be selected for current source V229. Depending on the position of S13, only one timing capacitor C219 (fast sweep speeds) or two timing capacitors C219/C218 (slow sweep speeds) are switched into the circuit. Capacitor C218 is switched into the circuit by means of transistor V231.

This transistor functions in the 'reversed' mode (collector and emitter are reversed) during the charge of the timing capacitor and in the 'normal' way during the discharge.

Switching of V231 is controlled by TIME/DIV switch S13. The table below indicates the capacitors and adjustment potentiometers that are in circuit as a function of the position of S13.

TIME/DIV range	Timing capacitors in circuit	Adjustment point
0,05 μ s...5 μ s/DIV	C219	R349
10 μ s...1 ms/DIV	C219, C218	R351

The time-base is switched on and off by means of the switching transistors V228 and V227. At the end of the DTB sweep V228 conducts and takes over the current from current source V229; V227 conducts at the start of the hold-off period in order to discharge the timing capacitance.

The DTB sawtooth is taken off by Darlington pair V219/V209 and routed to diode V211 in the X deflection selector. The sawtooth is also routed via emitter-follower V221 to the input of the end-of-sweep detector D203 (1,2,3).

a) COMPARATOR

This part of the circuit consists of transistors V259, V248 and current source V268 and it compares the MTB sawtooth voltage (applied to the base of V259) with an adjustable d.c. voltage from DELAY TIME potentiometer R3 (applied to the base of V248 via Darlington pair V246, V247).

At the moment that the instantaneous d.c. value of the MTB sawtooth exceeds the voltage on the base of V248, this transistor switches off, V259 conducts and the comparator switches over. Now V261 conducts and NAND-gate input D203-4 becomes H.

The comparator has a current source V268, which is switched on if the lower end of R358 is connected to earth via S13. With the DTB TIME/DIV switch S13 in the OFF position, R358 is floating and the current source is switched off. As a result, the comparator is inoperative and the DTB cannot be started.

The voltage at both ends of the DELAY TIME control R3 is adjustable by presets R262 and R268.

b) START and STOP of DTB (see timing diagram Fig. 2.8)

Before the start of the DTB, the position of the SR flip-flop D204 (1,2,3) and D204 (4,5,6) is as follows:

Output D204-1 – L

Output D204-4 – H

Input D203-4 becomes H if the comparator switches over. Input D203-5 is H (during the MTB sweep).

Consequently, output D203-6 becomes L together with input D204-12.

Input D204-11 is L, thus output D204-13 becomes H and is applied to the reset input, pin 1 of flip-flop D207.

There are now two start possibilities for the DTB:

- Pushbutton MTB of S22 is depressed: the 'START' mode is selected and the DTB starts directly after the selected DELAY TIME.

In this mode, the set input, pin 4 of flip-flop D207 is connected to earth, so the inverted form of the signal on output pin 1 of D207 appears on the output pin 6. If pin 1 goes H, then output pin 6 goes L, the switching transistor V228 turns off and the DTB starts.

- Pushbutton A or B of S22 is depressed: the TRIGGERED mode is selected and the DTB starts after the pre-selected time delay, only upon receipt of a trigger pulse.

In this mode, the set input D207-4 is H, and D207 now functions as a normal flip-flop.

After pin 1 has gone H, a clock-pulse on D207-3 is necessary to make output pin 6 logic L.

This clock-pulse occurs if V226, V212 (the CURRENT-VOLTAGE CONVERTER for the selected trigger source) and emitter-follower V225 make inverter inputs D203-12/13 logic L. As a result, the clock input D207-3 goes H and the flip-flop switches over: output pin 6 goes L and switch V228 now goes non-conductive and the time-base starts.

If the timing capacitance of the DTB is charged, the voltage across it rises linearly with time. This voltage is applied via the Darlington pair V219, V209, the voltage divider R239, R238 and emitter-follower V221 to the input of the Schmitt trigger D203 (1,2,3), which is the end-of-sweep detector.

If this voltage has reached a value of +1,9 V, the input level is detected as being H.

Output D203-3 now becomes L and is inverted to give H on output D203-8, which is applied to pin 6 of SR flip-flop D204 (1...6). The flip-flop switches over and gives a logic H on input D204-11.

Output D204-13 becomes L and also the reset input D207-1 and the DTB stops as switching transistor V228 conducts again. In this way, the charging of the timing capacitance stops, and these are discharged via V227 at the start of the hold-off period.

The situation described above is valid if the DTB sweep is completed before the MTB sweep (see Fig. 2.8, indicating the voltage waveforms for the DTB SWEEP COMPLETED mode, and also for the DTB SWEEP NOT COMPLETED mode).

In the DTB SWEEP NOT COMPLETED mode, the state of the RS flip-flop is not changed and the DTB is stopped if input D203-5 becomes L at the end of the MTB sweep. Now input D204-12 becomes H and flip-flop reset input D207-1 becomes L.

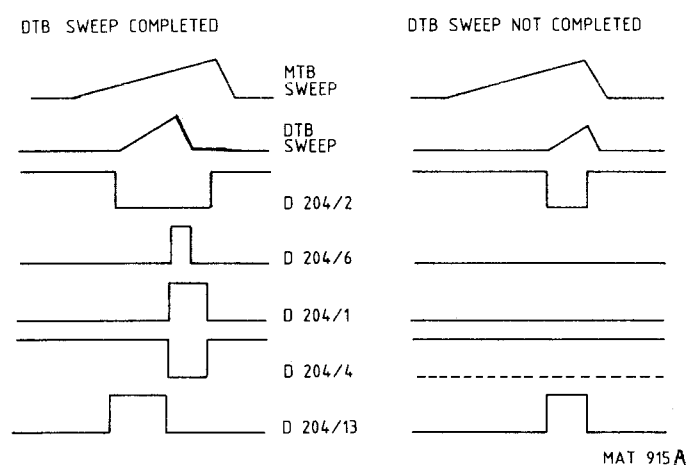

Fig. 2.8 Important voltage-waveforms in the DTB control logic

2.3.5. Final X Amplifier (see Fig. 8.13)

The input stage comprises a balanced series-feedback amplifier, V1371, V1372 with common current source V1373. The base of V1371 receives the output signal from the X-deflection selector. This signal can be the MTB or DTB sawtooth or the X DEFLECT signal. The base of V1372 receives an adjustable d.c. voltage derived from the X POSITION control R5.

This control, R5, consists of two ganged sections, one of which has a degree of backlash to enable fine and coarse adjustment of the X position with one knob.

The amplification of the V1371, V1372 stage is increased by x10 if the X MAGN control is pulled. Relay K1371 is energised in this mode and additional emitter resistance (R1378 and R1381) is switched into circuit.

The collector of transistor V1371 drives one half of the final X amplifier, the other half being driven by the collector of V1372. The configuration of both amplifier halves is the same, but corresponding transistors are complementary (PNP vs NPN) so corresponding supply voltages are therefore reversed (V1316 vs V1312). One half of the final X amplifier consists of V1302 (NPN to adapt d.c. level), V1306 (PNP shunt-feedback amplifier), V1311 (PNP, to adapt d.c. level), V1312 (NPN, current source) and V1313 (NPN, output emitter-follower).

The signal conditions are as follows:

If the sawtooth voltage on the base of V1371 rises, the collector current falls. The voltage level on the junction R1307-R1318 does not change. Therefore the current is fed via transistor V1302 to the base of V1306. The base becomes more negative, so the collector potential of V1306 rises. Also the potential on the junction of collectors V1311, V1312 rises and is applied via emitter-follower V1313 to one horizontal deflection plate. During the flyback of the sawtooth, diode V1308 can conduct. The feedback components of V1306 are R1323, R1318 and C1308.

The other half of the final X amplifier consists of V1303 (PNP, to adapt d.c. level) V1307 (NPN, shunt-feedback amplifier), V1317 (NPN, to adapt d.c. level), V1316 (PNP, current source) and V1314 (PNP output emitter-follower).

The signal conditions are as follows:

If the sawtooth voltage on the base of V1371 rises, the collector current of V1372 also rises. The emitter of V1303 becomes more positive. (Resistor R1308 has a higher value than R1307 in the other half of the amplifier.)

Transistor V1303 starts conducting so the current to the base of V1307 rises. The voltage level on the collector of V1307 decreases and the potential on the base of V1314 also.

Via emitter-follower V1314 the signal is fed to the horizontal deflection plate X1.

The feedback components for V1307 are R1319, R1324 and C1309

2.4. CRT DISPLAY SECTION, CAL GENERATOR AND FRONT-PANEL SIGNAL LAMPS (see Fig. 8.13.)

a) Z-Amplifier

The signal from the Z-LOGIC on the time-base unit 2 that determines the c.r.t. spot intensity is applied to the base of emitter-follower V1503. From the emitter the signal feeds the output stage with shunt-feedback amplifier V1513 and current source V1511.

The output signal may contain d.c., l.f. and h.f. components to be applied to the Wehnelt cylinder G1 of the c.r.t. Since G1 is at a cathode potential of -1500 V, blocking capacitors are required between G1 and the Z amplifier output.

The h.f. component is routed via blocking capacitor C1512 to G1.

However, the d.c. and l.f. components are blocked. These components are filtered by the low-pass filter R1529, C1514 and applied to the modulator V1508, V1509. Here, the d.c. and l.f. components modulate an h.f. carrier signal to pass blocking capacitor C1513, and are then demodulated by V1514. Finally, the reconstituted d.c. and l.f. components are added to the h.f. component and applied to G1 of the c.r.t.

b) Signal lamps

The front-panel LED indicators POWER ON, VERT UNCAL, HOR UNCAL, MAGN X10 and NOT TRIG'D are connected in series, and fed from constant-current source V1504.

The POWER ON LED always glows when the instrument is switched on. The other are short-circuited by the relevant switches when not in operation, as listed below:

- Vertical and horizontal UNCAL LEDs short-circuited if continuous controls R7, R8, R9, R10 are in CAL position.
- The MAGN x10 LED is short-circuited by V1512, which is blocked if the MAGN x10 mode is selected.
- The NOT TRIG'D LED is short-circuited if a logic L from the MTB logic is applied to its anode.

c) Trace rotation circuit

This circuit determines the magnitude and sense of the current in the trace rotation coil around the neck of the c.r.t. Either npn transistor V1501 or pnp transistor V1502 conducts depending on the setting of the front-panel adjustment R14. This control also determines the magnitude of the current.

d) Calibration generator

The square-wave generator consists basically of an operational amplifier D1501 with an RC feedback loop. This feedback loop consisting of R1543 and C1517 determines the frequency of oscillation (2 kHz).

The generator is followed by output stage V1516, which is used in the 'reversed' mode; i.e. the collector is used as 'emitter' and the emitter used as 'collector'.

In this way, the saturation voltage is very low, which gives an accurate output voltage on socket X1. Resistors R1547, R1548, R1549 in the output circuit are high-precision types.

e) Graticule illumination lamps

The graticule illumination lamps are supplied via transistor V2, which is mounted on the chassis for an optimal heat-conduction.

2.5. THE POWER SUPPLY

The stabilised power supply for the oscilloscope consists of the following:

- an input circuit
- a converter driver
- a flyback converter
- a regulator and protection circuit
- secondary output rectifiers

2.5.1. Input circuit

The instrument can be set to operate from the following mains supply voltages: 110 V, 220 V and 240 V a.c., these nominal voltages being selected by the mains voltage selector S25 at the rear of the instrument.

Fuse F1402 protects the instrument against incorrect mains voltage settings or high mains fluctuations. A thermal fuse F1403 is located in the mains transformer T1406.

The secondary winding of T1406 is connected to the diode bridge V1431, where the input is rectified and smoothed by capacitor C1452.

The instrument may alternatively be powered by a battery supply of 20...28 V. This battery supply must be connected via the d.c. input connector X7 at the rear of the instrument.

If a battery supply is used, it is applied to resistor R1460 via the POWER ON switch S21 and connector X1407 pins 6 and 8. Protection is provided by the 2 A delayed-action fuse F1401. Diode V1436 also safeguards the input against incorrect polarity of the battery supply. This diode blocks in the event of reversed input.

Resistor R1447 prevents capacitor C1452 being charged to excessive values by spikes that may be present on the battery supply.

To reduce the current flowing through C1441 at switch-on, resistor R1460 is mounted in series with the POWER ON switch S21.

2.5.2. Converter Driver and Flyback Converter

The converter driver consists of transistors V1438, V1413 and transformer T1404.
The converter itself consists of the converter transformer T1402.

– The converter driver (see Fig. 2.9 and 8.14)

The circuit functions as follows:

The pulse-width of the square-wave current I_1 that is applied to the base of transistor V1438 is determined by the integrated circuit D1402.

The frequency of the square-wave current is 26 kHz approximately.

If transistor V1438 starts to conduct (see point A of Fig. 2.9), its collector current I_2 increases to 0,4 A during the period T1.

The current I_2 is flowing via the primary winding of T1404 to the base of transistor V1413 (I_3) and to the secondary winding of T1404 (I_4).

The base current of V1413 (I_3) will increase by the same amount as the collector current of V1438 (I_2).

Transistor V1413 will conduct and its collector current I_6 will increase to 4 A.

If the transistor V1438 is blocked (see point B of Fig. 2.9) its collector current I_2 is switched off.

Because of this sudden switch-off, the current I_4 will be maximum at this moment.

The current I_4 is in anti-phase with respect to I_2 and flows via diode V1437 to the supply voltage.

In this way, the base current I_3 of V1413 becomes negative (-0,4 A) during period T2, which rapidly blocks V1413.

The collector current I_6 of V1413 is also switched off rapidly at this moment. The energy present in the transformer T1404 is fed to earth via diode V1419. This is realised by the negative current I_1 during period T3.

After $\approx 40 \mu\text{s}$, the procedure is repeated.

Resistor R1446 provides the base of V1413 with a d.c. current to speed-up the switching-on of this transistor.

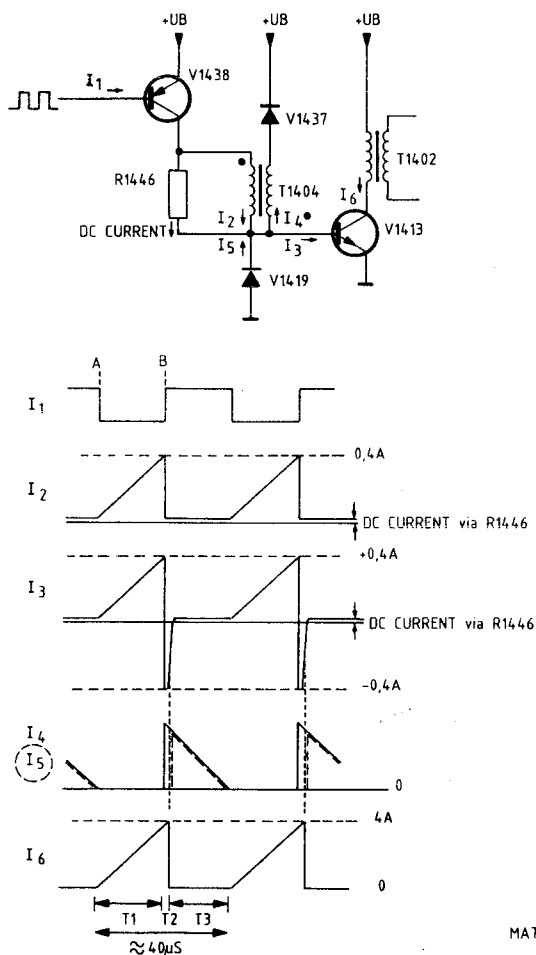

MAT 948

Fig. 2.9 Converter-driver

— The flyback converter (see Fig. 2.10)

The flyback converter functions as follows:

If transistor V1413 conducts under the control of base current I_3 , the collector current I_6 increases to 4 A. During the period T1, the voltage level on the collector of V1413 is at earth potential.

At the moment when V1413 is blocked its collector current I_6 is switched off (see point B of Fig. 2.10).

At the same time, the energy present in T1402, built up during period T1, is discharged via the secondary winding of T1402 during period T2.

This results in current I_7 which, after rectification and smoothing, is fed to the various circuits in the instrument.

The energy that was present in T1402 is consumed at point A and the procedure described above is repeated after $\approx 40 \mu\text{s}$.

Diode V1415, capacitor C1430 and resistors R1418, R1425 serve to eliminate the switching spikes present on the collector of transistor V1413.

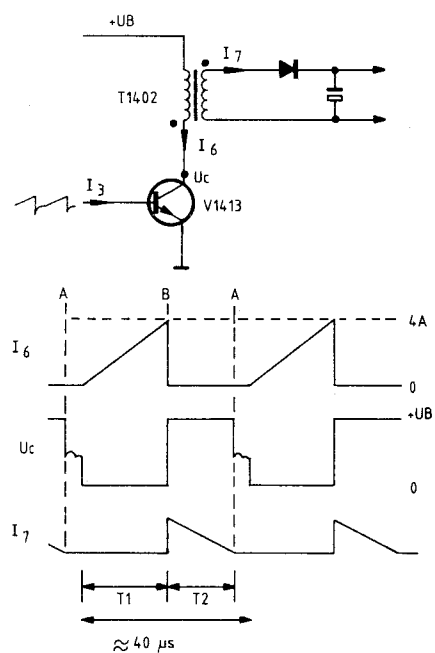

MAT 949

Fig. 2.10 Fly-back converter

2.5.3. The Regulator and Protection Circuit (see Fig. 8.15)

The regulator circuit D1402, via transistors V1433 and V1428, controls the pulse-width of the square-wave current applied to the base of V1438.

At the moment of switch-on, the supply voltage for D1402 is delivered via the emitter-follower V1429 to pin 1 of D1402.

When the power supply has started, the transistor V1429 is blocked and the supply voltage for D1402 is derived from the secondary +14 V supply via diode V1426.

The regulator circuit is controlled by the following:

- The +14 V secondary output voltage fed back to D1402-3 via potentiometer R1474 and resistors R1452, R1453 and R1456 for output voltage sensing.
Potentiometer R1474 permits adjustment of the output voltages.
- The frequency of the sawtooth generator, determined by the value of C1448 and R1466 connected to pins 8 and 7 of D1402 respectively (26 kHz approx.).
- The current-limit circuit, adjustable by preset R1476, for output current sensing.

a) Output voltage sensing

The voltage level of the feedback voltage (on D1402-3) is compared with the amplitude of the sawtooth voltage in the pulse-width modulator (see Fig. 2.11). The pulse-width modulator is part of integrated circuit D1402.

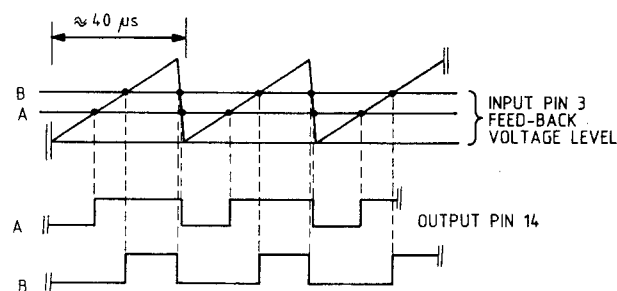

MAT 950

Fig. 2.11 Pulse-width modulation

The pulse-width of the output square-wave voltage is determined by the level of the feedback voltage to D1402-3. For instance, if the output voltage is too high (see level B of Fig. 2.11), the pulse-width of the output voltage on pin 14 and pin 15 will be reduced.

If the output voltage is too low (see level A of Fig. 2.11), the pulse-width will increase.

Via transistor V1428, the square-wave current is applied to the base of V1438. Transistor V1428 functions as a current source, started by the pulse from D1402-14. The square-wave voltage from D1402-15 switches-off transistor V1438 rapidly via transistor V1433 and C1449.

A 'slow' start of the power supply is achieved by capacitor C1447, which is charged slowly by the reference voltage from D1402-2 via resistors R1448 and R1462.

The voltage level on pin 6 determines the duty cycle of the output square-wave voltage.

The maximum duty-cycle is also determined by the voltage level on D1402-6 which prevents the converter transformer T1402 going into saturation.

The +14 V feedback voltage is continuously checked. A voltage level is applied to D1402-10 via the Zener diode V1422 and R1439.

In the event of a short-circuit longer than approximately two seconds, the voltage level on pin 10 will fall to such a value that the output pulses on pins 14 and 15 of D1402 are blocked.

b) Output current sensing

The voltage level derived from potentiometer R1476 is applied to D1402-11 for current sensing. This voltage level is taken from the current transformer T1403, This transformer has no power losses so its dissipation is low.

If the voltage level on D1402-11 exceeds 0,48 V, the output pulses from pins 14 and 15 are cut-off. This means that the duty-cycle of the square-wave output voltage is reduced, which in turn reduces the output current of the power supply (e.g. in the event of a small overload).

If the voltage level on pin 11 of D1402 exceeds 0,6 V (e.g. in the event of a short-circuit), the power supply is immediately switched-off.

2.5.4. Output Circuits (see Fig. 8.15)

The output voltages taken from the secondary windings of transformer T1402 are rectified by diodes and smoothed by capacitors in conventional circuits.

The d.c. output voltages are fed to the various circuits of the instrument. The c.r.t. filament is also supplied by a secondary winding of T1402, via connector X1406, pins 1 and 2.

WARNING Note that pin 2 of connector X1406 is at -1500 V level.

If connector X1406 is removed from its socket, the +14 V supply voltage for the -1500 V converter is also interrupted for safety reasons. In this case, the connection between the connector pins 9 and 10 is interrupted.

2.5.5. -1500 V Generator and HV Multiplier (see Fig. 8.15)

The -1500 V supply consists of an oscillator and a regulator circuit.

The oscillator comprises transistor V1401, transformer T1401, capacitor C1415 and resistor R1417. The output signal voltage on the secondary winding of T1401 is rectified by diode V1403 and smoothed by C1408 and C1409.

The -1500 V is divided by resistors R1408, R1413 and fed back to the positive input of operational amplifier D1401-3 for output voltage sensing.

This part of the -1500 V output is compared with a reference voltage applied to the inverting input D1401-2. The reference voltage is extremely stable, and independent of temperature variations. This is achieved by Zener diode V1408. Tolerances in this Zener diode can be compensated for by preset R1471.

Resistor R1434 and capacitor C1436 prevent unwanted oscillation in D1401.

The regulator part of the circuit functions as follows:

If for example the -1500 V output increases (i.e. goes more negative), the voltage level on the positive input D1401-3 decreases.

The output voltage of the comparator D1401-6 decreases to such a value that current is drawn from the oscillator via diode V1410.

Consequently, the oscillator amplitude decreases, resulting in a lower output voltage.

If the -1500 V is short-circuited, the voltage level on D1401-3 becomes positive, and the output voltage of the comparator D1401-6 increases. The current to the base of transistor V1401 increases as a result, and V1401 dissipates this current.

Diode V1410 prevents the transistor V1401 getting excessive base current when the instrument is switched on. At switch-on the diode blocks and the base current for V1401 is delivered via resistor R1426.

The -1500 V output is converted to 8,5 kV in the high-voltage multiplier D1403 and fed via connector X1414 to the post-acceleration anode of the c.r.t.

2.5.6. Line Trigger Pick-off (see Fig. 8.15)

The line trigger signal is derived from the secondary winding of the mains transformer via the connector X1407, pins 4 and 7.

The mains voltage sine-wave signal is applied to the transistor V1406 via resistors R1422 and R1423. The square-wave signal on the collector of V1406 is routed to a filter consisting of R1419, R1416, R1414 and C1416, C1417 and C1407, and transistor V1404.

This filter re-converts the square-wave voltage to a sine-wave voltage at the mains frequency.

This line trigger signal is routed via electrolytic capacitor C1406 to the TRIGGER SELECTION UNIT via the connector X858, pin 6.

2.6. BASIC ANALOG AND DIGITAL CIRCUITS

This section describes briefly the most important characteristics of the analog and digital circuits to be found in the instrument.

2.6.1. Basic Analog Circuits (see Fig. 2.12)

– Series feedback amplifier

This is also called a Cherry configuration.

A voltage signal ΔU is applied to the input; the output produces a current signal $\Delta I = \frac{\Delta U}{R_E}$

– Shunt feedback amplifier

This is also called a Hooper configuration.

A current signal ΔI is applied to the input; the output produces a voltage signal $\Delta U = \Delta I \cdot R_F$

– Series feedback amplifier followed by a shunt feedback amplifier

This combination of the two previous configurations is called a Cherry-Hooper circuit.

In this two-stage amplifier, both the input and the output are voltage signals. The gain of this amplifier is:

$$\frac{\Delta U_{OUT}}{\Delta U_{IN}} = \frac{R_F}{R_E}$$

– Emitter-follower

The emitter-follower is used as an impedance converter.

The input impedance is HIGH and the output impedance is LOW. The stage has a voltage gain of x1, and the output voltage signal is identical to the input voltage signal.

– Darlington pair

This circuit consists of two emitter-followers connected in cascade. As a result, the input impedance is very high and the output impedance low.

Again, this stage has a voltage gain of x1 and the output voltage signal is identical to the input voltage signal.

– Common base circuit

This type of circuit is frequently used between amplifier stages for d.c. voltage level adaption or for buffering.

The input impedance is low and the output impedance is high.

It has a current gain of x1, the output current signal being identical to the input current signal.

– Long-tailed pair

In the diagram of Fig. 2.12, the long-tailed pair is formed by transistors V1 and V2. Transistor V3 functions as a constant-current source for V1 and V2. The current drawn from V3 is divided between V1 and V2, the proportion depending on the base voltages applied (U1 and U2).

The division is as follows:

$$I_1 - I_2 = \frac{U_1}{R_{E1}} - \frac{U_2}{R_{E2}}$$

2.6.2. Basic Digital Circuits (see Fig. 2.13)

The type of logic used is TTL and the supply voltage +5 V.

The logic levels used are defined as follows:

- a high level (H) constitutes an input between 2...5 V and an output between 2,4...5 V.
- a low level (L) constitutes an input between 0...0,8 V and an output of between 0...0,4 V.

The following types of logic circuit elements are used this instrument:

- **AND-gate:** In this gate, the output is only H if all the inputs are H. Therefore, if one input is low, the state of the other inputs is irrelevant and the output is L.
- **NAND-GATE:** the output is only L if all the inputs are H. Therefore, if one input is L the state of the other inputs is irrelevant and the output is H.
- **OR-gate:** the output is only L if all inputs are L. If one input is H, then the state of the other inputs is irrelevant and the output is H.
- **NOR-gate:** the output is only H if all inputs are L. Therefore, if one input is H, the state of the other inputs is irrelevant and the output is L.
- **D-FLIP-FLOP:** One integrated circuit incorporates two flip-flops. Each flip-flop has an output (pin 5 or 9) and an inverted output (pin 6 or 8). If the reset input R (pin 1 or 13) is made L it is activated and the flip-flop is forced to the reset state: output L and inverted output H. The set input S (pin 4 or 10) is active when L and forces the flip-flop to the set state: output H and inverted output L. If the set and reset inputs are both H, the condition of the clock input CL (pin 3 or 11) and the data input D (pin 2 or 12) are important. The logic level on the data input (L or H) is clocked into the flip-flop if the clock goes L to H - now the output also becomes L or H.
- **JK FLIP-FLOP:** One IC contains two flip-flops. Each flip-flop has an output (pin 5 or 9) and an inverted output (pin 6 or 7). If the reset input R (pin 15 or 14) is made L, it is activated and the flip-flop is forced to the reset condition: output L and inverted output H.

The set input S (pin 4 or 10) is active when L and forces the flip-flop to the set condition : output is H and inverted output is L.

If both the set and reset inputs are H, the condition of the clock input C (pin 1 or 13), the J-input (pin 3 or 11) and the K-input (pin 2 or 12) are important.

If the clock input goes from H to L, the following occurs:

- If J = L and K = L: the output states remain unchanged.
- If J = H and K = L: the output becomes H and the inverting output L.
- If J = L and K = H: the output becomes L and the inverting output H.
- If J = H and K = H: the outputs switch to the opposite state.

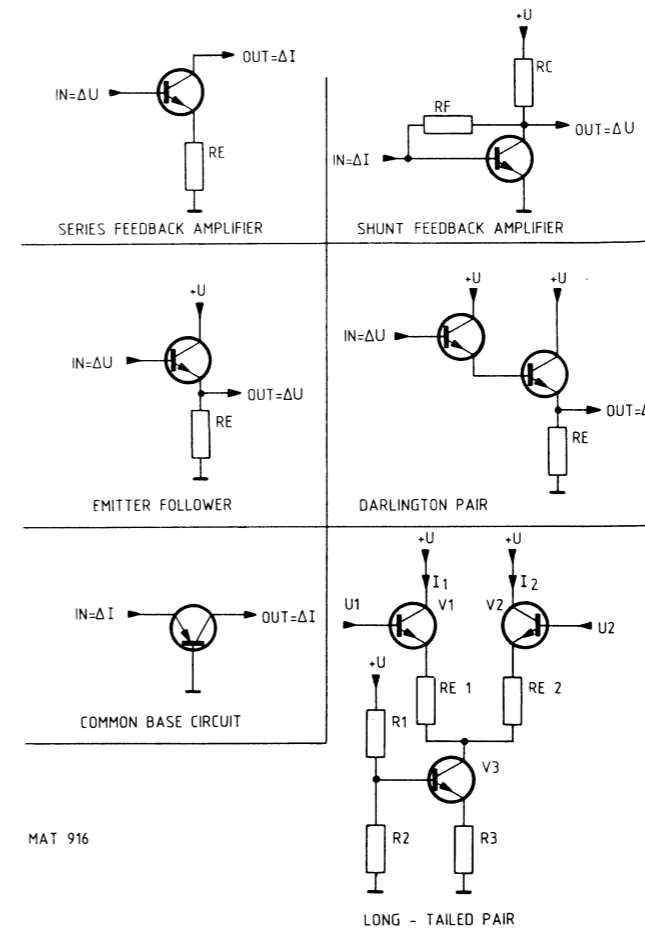

Fig. 2.12 Basic analog circuits

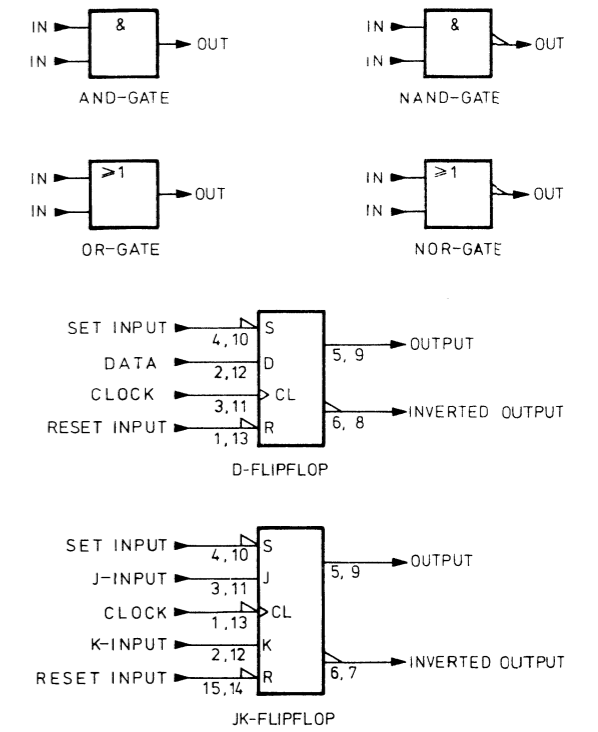

Fig. 2.13 Basic digital circuits

3. DISMANTLING THE INSTRUMENT

3.1. GENERAL INFORMATION

WARNING: The opening of covers or removal of parts, except those of which access can be gained by hand, is likely to expose live parts, and also accessible terminals may be live.

The instrument shall be disconnected from all voltage sources before any adjustment, replacement or maintenance and repair during which the instrument will be opened.

If afterwards any adjustment, maintenance or repair of the opened instrument under voltage is inevitable, it shall be carried out only by a qualified person who is aware of the hazard involved.

Bear in mind that capacitors inside the instrument may still be charged even if the instrument has been separated from all voltage sources.

ATTENTION

This section provides the dismantling procedures required for the removal of components during repair operations. All circuit boards removed from the oscilloscope should be adequately protected against damage, and all normal precautions regarding the use of tools must be observed. During dismantling procedures, a careful note must be made of all disconnected leads that they may be reconnected to their correct terminals during assembly.

Damage may result if the instrument is switched on when a circuit board has been removed, or if a circuit board is removed within one minute after switching off the instrument.

3.2. REMOVING THE INSTRUMENT COVERS

The instrument is protected by three covers: a front-panel protection cover, an instrument cover with carrying handle, and a rear panel.

To facilitate the removal of the instrument cover and rear panel, first ensure that the front cover is in position. Then proceed as follows:

- Hinge the carrying handle clear of the front cover by pushing both pivot centre buttons simultaneously.
- Stand the instrument on its protective front cover on a flat surface.
- Slacken the two coin-slot screws located on the rear panel.
- Lift the rear panel at the right-hand side. slit it a little to the right and take it off.
- Remove the four screws fixing the cast-aluminium profile.
- Remove the cast-aluminium profile.
- Remove the instrument cover by lifting it clear of the instrument.

NOTE: Bend out the cover at the side of the rubber feet so that the feet do not catch behind the frame parts.

3.3. ACCESS TO ADJUSTING ELEMENTS

All instrument adjustment points are accessible after removing the instrument cover, the screening plate of the time-base (secured by two star-screws) and the screening plate of the attenuator (secured by six star-screws). The correct adjustment of the channel A and B attenuator sections is not disturbed if the screening plate is remounted.

Five adjustment points on the power supply (Unit 6) are accessible via holes in the right-hand chassis plate of the instrument.

NOTE: Always use an insulated adjustment tool.

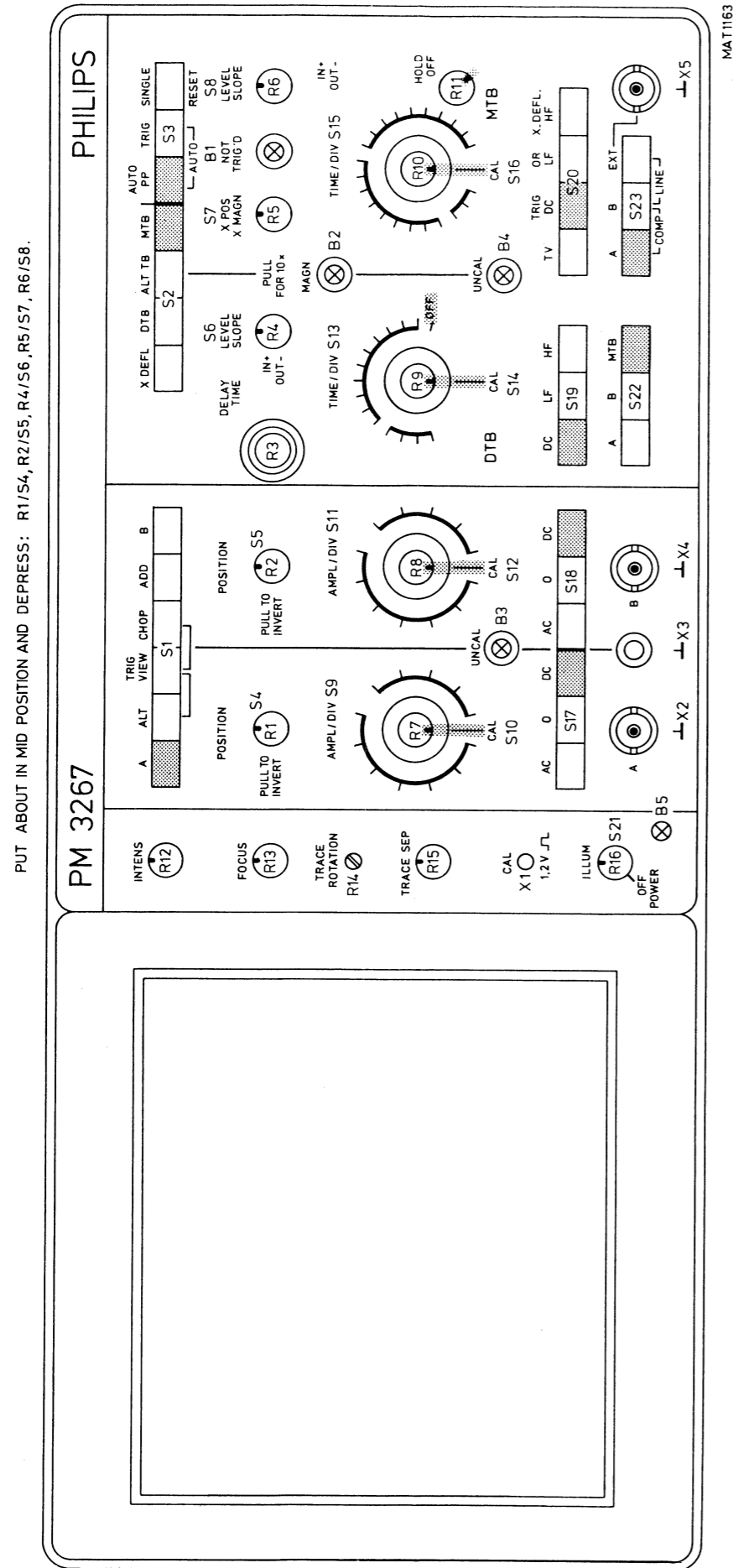

MAT1163

Fig. 4.1 Preliminary settings

4. PERFORMANCE CHECK

4.1. GENERAL INFORMATION

WARNING: Before switching on, ensure that the oscilloscope has been installed in accordance with the instructions outlined in chapter 2 of the operating manual, Installation instructions.

This procedure is intended to be used for incoming inspection to determine the acceptability of newly purchased or recently recalibrated instruments. It does not check every facet of the instrument's calibration; rather it is concerned primarily with those portions of the instrument which are essential to measurement accuracy and correct operation. Removing the instrument covers is not necessary to perform this procedure. All checks are made from the front panel.

If this test is started a few minutes after switching on, bear in mind that test steps may be out of specification, due to insufficient warming-up time. To avoid this situation, allow the specified warming-up time.

The performance checks are made with a stable, well-focused, low-intensity display. Unless otherwise noted, adjust the intensity and trigger-level controls as needed.

Note 1: At the start of every check, the controls always occupy the preliminary settings; unless otherwise stated.

Note 2: The input voltage has to be supplied to the A-input; unless otherwise stated.

Note 3: Set the TIME/DIV switches to a suitable position; unless otherwise stated.



4.2. PRELIMINARY SETTINGS OF THE CONTROLS

- Start this check procedure with **NO** input signals connected, **ALL** pushbuttons released and **ALL** switches in the CAL position.
- Depress the controls as indicated in figure 4.1.

4.3. RECOMMENDED TEST EQUIPMENT





Type of instrument	Required specification	Example of recommended instrument
Function generator	Freq: 1 Hz ... 10MHz Sine-wave/Square-wave Ampl.: 0 ... 20Vpp DC offset 0 ... ± 5 V Rise-time < 30ns Duty cycle 50%	Philips PM5134
Constant amplitude sine-wave generator	Freq: 100kHz ... 100MHz Constant ampl. of 120mVpp and 3Vpp	Tektronix SG503
Square-wave calibration generator	Freq: 10Hz ... 1MHz Ampl.: 50mV ... 60V Rise-time < 1ns Duty cycle 50%	Tektronix PG506
Time-marker generator	Repetition rate: 0.5s ... 0.05 μ s	Tektronix TG501
TV pattern generator	Must have video output	Philips PM5519
Variable mains transformer	Well insulated output voltage 90 ... 264Vac	Philips ord. number 2422 529 00005
DC power supply	Adjustable output: 20 ... 32V Current: 1,8A	Philips PE1540
Moving-iron meter		
Dummy probe 2 : 1	1M Ω \pm 0.1% //25pF	
Cables, T-piece, terminations, 20dB attenuator for the generators	General Radio types for fast rise-time square-wave and high freq. sine-wave BNC-types for other applications	

4.4. CHECKING PROCEDURE

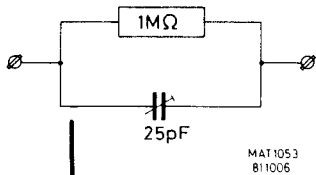
STEP	OBJECTIVE	INPUT VOLTAGE	SETTINGS	REQUIREMENTS	MEASURING RESULTS
4.1.	Power on				
4.1.1a	Start power supply	Mains voltage 50Hz - 400Hz \pm 10%	– Switch power on S21	– Start at selected mains voltage \pm 10% – Pilot lamp B5 lights up.	
4.1.2a	Power consumption			45W from ac	
4.1.1b	Start POWER SUPPLY	24V (x7 - rear side)	– Switch power on S21	– Starts at dc supply voltages between 20V and 32V – Pilot lamp B5 light ups.	
4.1.2b	Power consumption			37W from dc.	
4.2.	CRT display				
4.2.1.	INTENS		– INTENS potentiometer  R12	Normal INTENS adjusting	
4.2.2.	FOCUS		– FOCUS potentiometer  R13	Trace sharpness adjusting	
4.2.3.	TRACE ROTATION		– Screwdriver adjustment R14	Trace must be in parallel with horizontal graticule lines; if necessary readjust potentiometer TRACE ROTATION R14	
4.3.	Vertical or Y-axis				
4.3.1.	Display modes	Square-wave signal 10kHz ampl. 100mV to A input	– Depress A S1 – Ampl/div. to 20mV – Depress B S1 – Depress TRIG VIEW S1 – Depress CHOP S1 – Depress TRIG VIEW and CHOP S1 – Depress ALT S1 – Depress TRIG VIEW and ALT S1	Square-wave 10kHz 5 div. high must be visible Trace channel B visible Trigger signal derived from A visible Traces of A and B visible Traces of A and B and TRIG VIEW visible Traces of A and B visible Traces of A and B and TRIG VIEW visible	
		Square-wave signal 10kHz, ampl. 200mV to A and B input	– Depress ADD S1 – AMPL/DIV switches to 50mV	Square-wave signal 10kHz, trace height 8 div. visible	
4.3.2.	Polarity inversion	Square-wave signal to A (B) input	Pull switch S4 (S5)	Square-wave signal is inverted	

STEP	OBJECTIVE	INPUT VOLTAGE	SETTINGS	REQUIREMENTS	MEASURING RESULTS
4.3.3.	Vertical deflection coefficients	Square-wave signal 10kHz to A input (B)	AMPL/DIV S9 (S11)		
		AMPL 10mVp-p 20mVp-p 50mVp-p 100mVp-p 200mVp-p 500mVp-p 1 Vp-p 2 Vp-p 5 Vp-p 10 Vp-p 20 Vp-p 50 Vp-p	2mV 5mV 10mV 20mV 50mV 0.1V 0.2V 0.5V 1 V 2 V 5 V 10 V	Trace height 5 DIV., + or -3% (± 0.15 div.) Trace height 4 DIV., + or -3% (± 0.12 div.) Trace height 5 DIV., + or -3% (± 0.15 div.) Trace height 5 DIV., + or -3% (± 0.15 div.) Trace height 4 DIV., + or -3% (± 0.12 div.) Trace height 5 DIV., + or -3% (± 0.15 div.) Trace height 5 DIV., + or -3% (± 0.15 div.) Trace height 5 DIV., + or -3% (± 0.15 div.) Trace height 4 DIV., + or -3% (± 0.12 div.) Trace height 5 DIV., + or -3% (± 0.15 div.) Trace height 5 DIV., + or -3% (± 0.15 div.) Trace height 4 DIV., + or -3% (± 0.12 div.) Trace height 5 DIV., + or -3% (± 0.15 div.) Trace height 4 DIV., + or -3% (± 0.12 div.) Trace height 5 DIV., + or -3% (± 0.15 div.)	
4.3.3.1.	Continuous control	Square-wave signal 10kHz to A input (B) ampl. 100mV	- AMPL/DIV to 20mV - Continuous control S10 (S12)	- Continuous range 1 : > 2.5 (≤ 2 div.) - Uncal led B3 lights up	
4.3.4.	Vertical positioning	Sine-wave signal 10kHz to input A (B) Amplitude 160mVp-p	- AMPL/DIV to 20mV - Set signal in vertical centre by means of position R1 (R2) - Set AMPL/DIV to 10mV - Position control R1 (R2) fully - Position control R1 (R2) fully	- Top of sine-wave visible on the screen on the vertical centre line. - Bottom of sine-wave visible on the vertical centre line.	
4.3.5.	Vertical deflection via dummy (Input impedance)	Square-wave signal 10kHz to input A via dummy (B)	AMPL/DIV S9 (S11)		
		AMPL 20mVp-p 50mVp-p 100mVp-p 200mVp-p 500mVp-p 1 Vp-p 2 Vp-p 5 Vp-p 10 Vp-p 20 Vp-p	2mV 5mV 10mV 20mV 50mV 0.1V 0.2V 0.5V 1 V 2 V	Trace height 5 div., + or -3% (± 0.15 div.) Trace height 5 div., + or -3% (± 0.15 div.) Trace height 5 div., + or -3% (± 0.15 div.) Trace height 5 div., + or -3% (± 0.15 div.) Trace height 5 div., + or -3% (± 0.15 div.) Trace height 5 div., + or -3% (± 0.15 div.) Trace height 5 div., + or -3% (± 0.15 div.) Trace height 5 div., + or -3% (± 0.15 div.) Trace height 5 div., + or -3% (± 0.15 div.) Trace height 5 div., + or -3% (± 0.15 div.) Trace height 5 div., + or -3% (± 0.15 div.)	



STEP	OBJECTIVE	INPUT VOLTAGE	SETTINGS	REQUIREMENTS	MEASURING RESULTS
4.3.6.	Input coupling	50Vp-p 50Vp-p Sine-wave signal 2kHz + DC offset to A input (B)	5V 10V – Depress 0 of S17 (S18) – Set the trace in the centre of the screen R1  (R2 ) – Depress AC of S17 (S18) – Depress DC of S17 (S18)	Trace height 5 div., + or –3% (± 0.15 div.) Trace height 2.5 div., + or –3% Signal is visible on the screen, centre of the sine-wave is on the vertical centre of the screen. Signal is visible Centre of the sine-wave is on DC offset level.	
4.3.7.	Common mode rejection	Sine-wave signal 2MHz ampl. 0.16V to A and B input	– AMPL/DIV switches to 20mV – Pull N/I switch S5 – Set the continuous controls for minimum trace height difference – Depress ADD of S1	Rejection 40dB \rightarrow trace height ≤ 0.08 div	
4.3.8.	Dynamic range	Sine-wave signal 40MHz, ampl. 2.4V to input A (B)	– Depress AC of S17 (S18) – AMPL/DIV to 0.1V – Shift trace with POSITION control R1  (R2 )	24 div. trace height distortion-free visible on screen	
		Sine-wave signal 100MHz, ampl. 0.8V to input A (B)	– AMPL/DIV to 0.1V	8 div. trace height distortion-free visible on screen.	
4.3.9.	Decoupling factor	Sine-wave signal 100MHz to A input ampl. 160mV	– AMPL/DIV switches to 20mV – Depress B of S1	Cross talk from A to B ≤ 0.15 div	

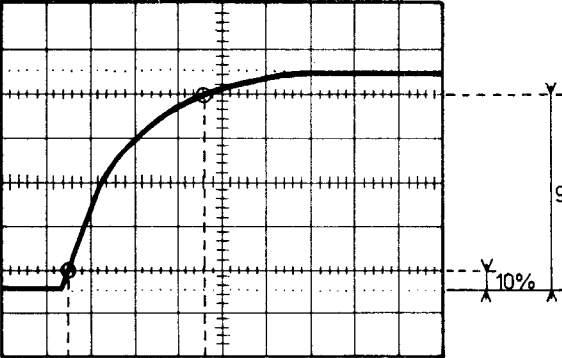
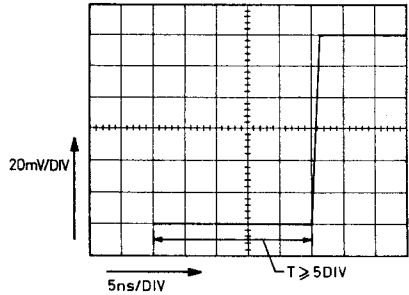

STEP	VOLTAGE	INPUT VOLTAGE	SETTINGS	REQUIREMENTS	MEASURING RESULTS
4.3.10.	Pulse aberration, rise time	Square-wave signal 1MHz, rise-time $\leq 1\text{ns}$, ampl. 12mV to A input (B) Square-wave signal 1MHz, rise-time $\leq 1\text{ns}$, ampl. 0.6V to input A (B) Square-wave signal 1MHz, rise-time $\leq 1\text{ns}$, ampl. 50mV to input A (B)	<ul style="list-style-type: none"> - AMPL/DIV to 2mV - Position controls R1 (R2) ↻ - AMPL/DIV to 0.1V - Positions control R1 (R2) ↻ - AMPL/DIV to 10mV - Set signal between dotted lines 	<ul style="list-style-type: none"> - Trace height 6 div., + and -3 div. from screen centre - Pulse aberrations $\leq 4\%$ ($\leq 5\%$ p-p) - Trace height 6 div., + and - 3div. from screen centre - Pulse aberrations $\leq 3\%$ ($\leq 4\%$ p-p) - Trace height 5 div. - Rise-time measured between 10% and 90% (4 div.) must be $\leq 3.5\text{ ns}$  <p style="text-align: right;">MAT 861</p> <p>Rise time measurement $t_R = t_2 (90\%) - t_1 (10\%)$.</p> <ul style="list-style-type: none"> - Visible signal delay 30ns approx. (6 div.) - MAGN led B2 lights up  <p style="text-align: right;">MAT 1172</p>	
4.3.11.	Visible signal delay	Square-wave signal 1MHz, rise-time $\leq 1\text{ns}$ ampl. 300mV to A input	<ul style="list-style-type: none"> - AMPL/DIV to 50mV - Pull X MAGN switch (S7) - TIME/DIV switch to $0.05\mu\text{s}$ 	<ul style="list-style-type: none"> - Visible signal delay 30ns approx. (6 div.) - MAGN led B2 lights up 	



STEP	OBJECTIVE	INPUT VOLTAGE	SETTINGS	REQUIREMENTS	MEASURING RESULTS
4.3.12.	Trace jump a) attenuator b) normal/invert c) continuous control		<ul style="list-style-type: none"> – Depress 0 of S17 (S18) – Set trace in the centre of the screen – Switch AMPL/DIV switch between 10V ... 20 div – Switch AMPL/DIV switch between 2mV and 20mV – Depress 0 of S17 (S18) – Trace in the centre of the screen – Pull and push switch S4 (S5) – AMPL/DIV: 10V ... 20mV/div – AMPL/DIV: 10mV ... 2mV/div – Depress 0 of S17 (S18) – Set trace in the centre of the screen – Rotate the continuous control R7 (R8) 	<p>Trace jump ≤ 0.2 div.</p> <p>Trace jump ≤ 0.4 div.</p> <p>Trace jump ≤ 1 div</p> <p>Trace jump ≤ 2 div</p> <p>Trace jump ≤ 0.3 div.</p>	
4.3.13.	Bandwith channel A (B)	<p>Sine-wave signal 500kHz... ampl. 120mV to input A (B)</p> <p>Sine-wave signal 500kHz, 100MHz, ampl. 120mV to input A (B).</p>	<ul style="list-style-type: none"> – TIME/DIV switch S15 to 5μs – AMPL/DIV switch to 20mV – Adjust generator to ampl. of input signal to trace height 6 div. 	<p>Trace height must be ≥ 4.2 div.</p>	



STEP	OBJECTIVE	INPUT VOLTAGE	SETTINGS	REQUIREMENTS	MEASURING RESULTS
4.4.	Trigger view				
4.4.1.	Sensitivity A (B)	Square-wave signal 1kHz to A input (B) AMPL. 10mV 20mV 50mV 100mV 200mV 500mV 1 V 2 V 5 V 10 V 20 V 50 V	– Depress TRIG VIEW S1. – AMPL/DIV switch S9 (S11) to 2mV 5mV 10mV 20mV 50mV 0.1V 0.2V 0.5V 1 V 2 V 5 V 10 V	Trace height 5 div. + or – 10% (± 0.5 div.) Trace height 4 div. + or – 10% (± 0.4 div.) Trace height 5 div. + or – 10% (± 0.5 div.) Trace height 5 div. + or – 10% (± 0.5 div.) Trace height 4 div. + or – 10% (± 0.4 div.) Trace height 5 div. + or – 10% (± 0.5 div.) Trace height 5 div. + or – 10% (± 0.5 div.) Trace height 4 div. + or – 10% (± 0.4 div.) Trace height 5 div. + or – 10% (± 0.5 div.) Trace height 5 div. + or – 10% (± 0.5 div.) Trace height 4 div. + or – 10% (± 0.4 div.) Trace height 5 div. + or – 10% (± 0.5 div.)	



STEP	OBJECTIVE	INPUT VOLTAGE	SETTINGS	REQUIREMENTS	MEASURING RESULTS
4.4.2.	Sensitivity EXT	Sine-wave signal 1kHz to EXT input X5 Ampl. 1.2V	<ul style="list-style-type: none"> - Depress EXT of S23 - Depress TRIG VIEW of S1 	Trace height 6 div. \pm 3% (\pm 0.18 div.)	
4.4.3.	Pulse aberrations	<p>Square-wave signal 1MHz, Ampl. 120mV, rise time \leq 1ns, to input A (B)</p> <p>Square-wave signal 1MHz, ampl. 1.2V, rise-time \leq 1μs to input EXT X5.</p>	<ul style="list-style-type: none"> - AMPL/DIV to 20mV - Depress TRIG VIEW S1 - Depress A (B) of S23. - Depress TRIG VIEW S1 - Depress EXT of S23 	<p>Trace height 6 div. Pulse aberrations 10% p-p</p> <p>Trace height 6 div. Pulse aberrations \leq 6% (\leq 8% p-p)</p>	
4.4.4.	Trigger threshold	Sine-wave signal 10kHz, ampl. 200mV to input A	<ul style="list-style-type: none"> - Depress TRIG VIEW S1 - Set AMPL/DIV to 0.2V - Continuous control R7  	Minimum triggered trace height \pm 0.3 div. from screen centre	
4.4.5.	Time delay between vertical input displayed via A or B and external input displayed via trigger view.	Square-wave signal 1MHz, ampl. 1.2V, rise-time 1ns to A (B) input and to EXT input	<ul style="list-style-type: none"> - AMPL/DIV to 0.2V/DIV - Depress ALT and TRIG VIEW of S1 - TIME/DIV switch S15 to 0.05μs - Pull X MAGN S7 - Depress EXT of S23 	- Time delay between A (B) signal and EXT (via TRIG VIEW) signal must be 6ns approx.	
4.4.6.	Bandwidth INT	Sine-wave signal 500kHz, ampl. 120mV to input A	<ul style="list-style-type: none"> - Depress TRIG VIEW S1 - AMPL/DIV to 20mV - Adjust the generator to ampl. of the input signal to 6 div. trace height 	Trace height must be \geq 4.2 div.	
	Bandwidth EXT	<p>Sine-wave signal 500kHz, ampl. 3V to EXT input X5</p> <p>Sine-wave signal 500kHz ... 70MHz, ampl. 1.2V to EXT input X5</p>	<ul style="list-style-type: none"> - Depress TRIG VIEW S1 - Depress EXT of S23 - Adjust the generator to ampl. of the input signal to trace height 6 div. 	Trace height must be \geq 4.2 div.	

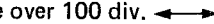

STEP	OBJECTIVE	INPUT VOLTAGE	SETTINGS	REQUIREMENTS	MEASURING RESULTS
4.5.	Horizontal or X-axis				
4.5.1.	Display modes	Square-wave signal 2kHz, ampl. 120mV to input A	<ul style="list-style-type: none"> – AMPL/DIV to 50mV – TIME/DIV MTB (S15) to 0.2ms – Depress MTB of S2 – TIME/DIV DTB (S13) to 50μs – Depress DTB of S2 – Depress ALT TB of S2 – Depress X DEFL of S2 	<ul style="list-style-type: none"> – Square-wave signal 2.4 div. high MTB (trace) – Intensified part DTB visible – Intensified part (DTB) visible over the entire screen width – MTB trace with intensified part and DTB trace visible. Adjust vertical spacing between both displays with TRACE SEP control R15. – Horizontal deflection is determined by the input signal A (2.4 div.) 	
4.5.2.	Horizontal positioning range		<ul style="list-style-type: none"> – X POS control R5 ↷ – X POS control R5 ↶ 	<p>Starting point trace to horizontal centre of the screen</p> <p>End of trace to horizontal centre of the screen</p>	
4.6.	Triggering of the main time-base			<p><i>NOTE: If signal is triggered the NOT TRIG'D led B1 is off.</i></p>	
4.6.1.	Trigger source and trigger coupling	<p>Square-wave signal 2kHz ampl. 300mV to input A</p> <p>Square-wave signal 2kHz, 300mV to input B and EXT (X5)</p>	<ul style="list-style-type: none"> – AMPL/DIV switch (S9) to 50mV – Depress LF of S20 – Depress TRIG VIEW of S1 – Depress HF of S20 – Depress B of S1 – AMPL/DIV (S11) to 50mV – Depress DC of S20 – Depress B of S23 – Depress EXT of S23 	<p>Well triggered display</p> <p>Square-wave signal visible with roundings (LF filter)</p> <p>Differentiated square-wave visible</p> <p>Well triggered display</p> <p>Well triggered display</p>	

STEP	OBJECTIVE	INPUT VOLTAGE	SETTINGS	REQUIREMENTS	MEASURING RESULTS
4.6.2.	Trigger sensitivity INTERNAL	<p>TV signal from TV pattern generator to input A (B)</p> <p>Sine-wave signal 10kHz, ampl. 120mV to input A and CAL signal to input B</p> <p>Sine-wave signal, derived from mains freq., ampl. 120mV to input A (B)</p> <p>Sine-wave signal freq. \leq 40MHz, ampl. 100mVp-p to input A</p> <p>Sine-wave signal freq. \leq 100MHz, ampl. 150mVp-p to input A</p>	<ul style="list-style-type: none"> - Depress TV of S20 - Adjust A (B) AMPL/DIV to \geq 0.7 div. sync. pulse amplitude - Depress A (B) of S23 - Depress A (B) of S1 - AMPL/DIV to 50mV - Depress A and B (COMP) of S23 - Depress ALT of S1 - Depress A (B) of S1 - Depress B and EXT (LINE) of S23 - AMPL/DIV to 0.2V - Adjust generator to 0.5 div. trace height - AMPL/DIV to 0.1V - Adjust generator to 1.5 div. trace height 	<p>Check for stable triggering on TV frame pulses at MTB TIME/DIV settings 0.5s/div. ... 50μs/div. and on TV line pulses at MTB TIME/DIV settings 20μs/div. ... 50ns/div</p> <p>Both input signals (that have no time relation) well triggered displayed (both input signals must overlap each other)</p> <p>Well triggered display</p> <p>Signal triggers at trace height of \geq 0.5 div.</p> <p>Signal triggers at trace height of \geq 1.5</p>	
4.6.3.	Trigger sensitivity EXTERNAL	<p>Sine-wave signal freq. \leq 40MHz, ampl. 100mVp-p to inputs A and EXT (X5)</p> <p>Sine-wave signal freq. \leq 100MHz, ampl. 300mV p-p to inputs A and EXT (X5)</p>	<ul style="list-style-type: none"> - AMPL/DIV to 50mV - Depress EXT of S23 - Decrease amplitude of input signal - AMPL/DIV to 0.1V - Decrease amplitude of input signal 	<p>Signal is well triggered at an amplitude \geq 100mV (2 div trace height)</p> <p>Signal is well triggered at an amplitude \geq 300mV (3 div trace height)</p>	
4.6.4.	Level range and triggering slope	<p>Sine-wave signal ampl. 160mV, p-p freq. 1kHz to input A</p>	<ul style="list-style-type: none"> - AMPL/DIV to 10mV - Depress TRIG of S3 - Depress TRIG VIEW of S1 - LEVEL R6  - Depress LF of S20 - LEVEL R6  - Pull SLOPE S8 - AMPL/DIV to 20mV - Depress AUTO PP of S3 - LEVEL R6  	<p>Trace is triggered over \pm 8 div., trigger point on positive slope</p> <p>Trigger point on negative slope</p> <p>Triggered signal over the complete LEVEL range</p>	

STEP	OBJECTIVE	INPUT VOLTAGE	SETTINGS	REQUIREMENTS	MEASURING RESULTS
4.6.5.	Trigger bandwidth	<p>Sine-wave signal 1kHz, ampl. 3.2V to EXT input X5</p> <p>Sine-wave signal 25kHz, ampl. 300mV to input A</p> <p>Sine-wave signal, 25kHz to input A</p>	<ul style="list-style-type: none"> - Depress EXT of S23 - Depress TRIG of S3 - LEVEL R6  - Depress DC of S20 - Depress TRIG of S3 - AMPL/DIV to 50mV - Depress TRIG VIEW - Set trace in the centre by means of R6  - Decrease freq. of input signal to \approx 1Hz (trace height 6 div.) - Increase freq. of input signal to 100MHz - Depress DC of S20 - Adjust ampl. of input signal so that trace height is 6 div. - Depress LF of S20 - Decrease freq. of input signal to 2Hz - Depress HF of S20 - Freq. of input signal 25kHz - Increase freq. of input signal to 100MHz 	<p>Trigger point adjustable over the complete amplitude (\pm 1.6V)</p> <p>Trace must be triggered</p> <p>Trace must be triggered</p> <p>Trace must be triggered</p> <p>Trace height 6 div.</p> <p>Trace height \geq 4.2 div. Trace height increases and signal must be triggered</p> <p>Trace height \geq 4.2 div.</p> <p>Trace height increases and signal must be triggered</p>	

STEP	OBJECTIVE	INPUT VOLTAGE	SETTINGS	REQUIREMENTS	MEASURING RESULTS
4.7.	Main time-base			Measured over 8 div. in horizontal screen centre:	
4.7.1.	Time coefficients	Time-marker signal, repetition time: 0.05 μ s 0.1 μ s 0.2 μ s 0.5 μ s 1 μ s 2 μ s 5 μ s 10 μ s 20 μ s 50 μ s 0.1 ms 0.2 ms 0.5 ms 1 ms 2 ms 5 ms 10 ms 20 ms 50 ms 0.1 s 0.2 s 0.5 s	– MTB TIME/DIV S15 to 0.05 μ s 0.1 μ s 0.2 μ s 0.5 μ s 1 μ s 2 μ s 5 μ s 10 μ s 20 μ s 50 μ s 0.1 ms 0.2 ms 0.5 ms 1 ms 2 ms 5 ms 10 ms 20 ms 50 ms 0.1 s 0.2 s 0.5 s	Coefficient error \leq \pm 3% Coefficient error \leq \pm 3%	
4.7.2.	Magnifier	Square-wave signal repetition time 0.1 μ s to input A	– TIME/DIV to 1 μ s – Pull X MAGN. S7 – X pos R5 	– MAGN. led B2 lights up – Coefficient error \leq \pm 5% – Trace adjustable over 100 div. 	
4.7.3.	Continuous control	As 4.7.2.	– TIME/DIV to 0.1 μ s – Continuous control CAL R10 	– UNCAL led B4 lights up – Continuous range 1 : \geq 2.5	

STEP	OBJECTIVE	INPUT VOLTAGE	SETTINGS	REQUIREMENTS	MEASURING RESULTS
4.7.4.	Single shot	Square-wave signal 10kHz to input A	<ul style="list-style-type: none"> - TIME/DIV to 0.1ms - Depress SINGLE of S3 	<ul style="list-style-type: none"> - Trace once visible - During SINGLE shot action NOT TRIG'D led B1 lights up 	
4.7.5.	Hold off	Square-wave signal repetition time 10 μ s to input A	<ul style="list-style-type: none"> - TIME/DIV to 2μs - HOLD OFF R11  	<ul style="list-style-type: none"> - Sweep HOLD OFF time can be varied by a factor of 10 \rightarrow trace intensity decreases. 	
4.8.	Triggering of the delayed time-base				
4.8.1.	Trigger source, trigger coupling and trigger bandwidth	<p>Sine-wave signal 2kHz ampl. 300mV to input A</p> <p>Sine-wave signal 2kHz ampl. 300mV to input B</p>	<ul style="list-style-type: none"> - AMPL/DIV to 0.1V - TIME/DIV MTB (S15) to 0.5ms - TIME/DIV DTB (S13) to 50μs - Depress A of S22 - Adjust LEVEL R4  - Depress DTB of S2 - Increase freq. of input signal to 100MHz. - Depress HF of S19 - Decrease freq. of input signal to 25kHz. - Depress LF of S19 - Decrease freq. of input signal to 2Hz. - Depress DC of S19 - Depress MTB of S2 - Depress B of S1 - Depress B of S23 - Depress B of S22 - Adjust LEVEL R4  - Depress MTB of S22 	<ul style="list-style-type: none"> - Well triggered intensified part (DTB signal) - Well triggered intensified part - Trace must be well triggered - Trace must be well triggered. - Trace must be well triggered - Well triggered intensified part - Intensified part well triggered independent of R4. 	

STEP	OBJECTIVE	INPUT VOLTAGE	SETTINGS	REQUIREMENTS	MEASURING RESULTS
4.8.2.	Trigger sensitivity	<p>Sine-wave signal freq. \leq 40MHz, ampl. 100mVp-p to input A</p> <p>Sine-wave signal freq. \leq 100MHz, ampl. 300mVp-p to input A</p>	<ul style="list-style-type: none"> - AMPL/DIV to 0.2V - TIME/DIV MTB (S15) to 0.05μsec. - TIME/DIV DTB (S13) to 0.05μsec. - Depress A of S22 - Depress DTB of S22 - Adjust LEVEL R4  - Adjust generator to 0.5 div. trace height - Adjust level R4  - Adjust generator to 0.5 div. trace height 	<p>Signal triggers at trace height of \geq 0.5 div.</p> <p>Signal triggers at trace height of \geq 1.5 div.</p>	
4.8.3.	Level range and triggering slope	Sine-wave signal 1kHz ampl. 160mV to input A (B)	<ul style="list-style-type: none"> - AMPL/DIV to 10mV - TIME/DIV MTB (S15) to 0.5ms - TIME/DIV DTB (S13) to 0.1ms - Depress A (B) of S22 - Depress DTB of S2 - Adjust LEVEL R4  - Pull slope S6 	<p>Trace is triggered over \pm 8 div., trigger point on positive slope</p> <p>Trigger point on negative slope</p>	

STEP	OBJECTIVE	INPUT VOLTAGE	SETTINGS	REQUIREMENTS	MEASURING RESULTS
4.10.2.	Bandwidth via A	Sine-wave signal 10kHz to input A	<ul style="list-style-type: none"> - Depress A of S23 - Depress DC of S20 - Depress X DEFL of S2 - Depress B of S1 - Adjust ampl. of input signal for horizontal deflection 8 div. - Increase freq. of input signal to 100kHz 	Horizontal deflection 8 div.	
		Sine-wave signal 1kHz to input A	<ul style="list-style-type: none"> - Depress LF of S20 - Adjust ampl. of input signal for horizontal deflection 8 div. - Increase freq. of input signal to 20kHz (ampl. same as above) - Depress HF of S20 - Increase freq. of input signal to 1MHz 	Horizontal deflection 8 div. (-5%) Horizontal deflection 8 div. Horizontal deflection decreases Horizontal deflection increases Horizontal deflection increases	
	Bandwidth via EXT. input (X5)	Sine-wave signal 10kHz to input EXT (ampl. 1.6V)	<ul style="list-style-type: none"> - Depress EXT of S23 - Adjust ampl. of input signal for 8 div. horizontal deflection - Increase freq. of input signal to 1MHz 	Trace width 8 div. (-3%)	
4.10.3.	Dynamic range	Sine-wave signal 100kHz to input A	<ul style="list-style-type: none"> - Depress X DEFL of S2 - Depress B of S1 - AMPL/DIV to 0.2V - Set ampl. of input signal for horizontal deflection 5 div. - AMPL/DIV to 50mV 	Horizontal deflection 20 div.	

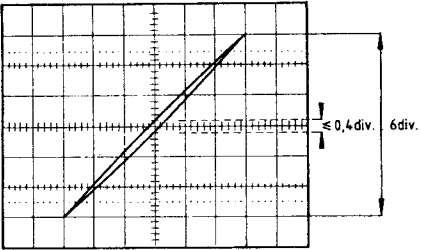
STEP	OBJECTIVE	INPUT VOLTAGE	SETTINGS	REQUIREMENTS	MEASURING RESULTS
4.10.4.	Phase shift between X and Y ampl.	Sine-wave signal 2kHz, ampl. 120mV to input A	<ul style="list-style-type: none"> – Depress X DEFL of S2 – Depress DC of S20 – Adjust amplitude of input signal for a trace height of 6 div. – Increase the freq. of the input signal to 100kHz – Put A AMPL/DIV in 20mV position 	<p>A line under an angle of 45° with respect to the horizontal graticule line visible</p> <p>Phase shift $\leq 3^\circ$</p>  <p style="text-align: right;">MAT 985</p>	
4.11.	Calibration		CAL X1	<p>\approx 2kHz square-wave signal, ampl. 1.2Vp-p short-circuit protected</p>	
4.12.	Z-Modulation	TTL compatible square-wave signal to input Z-MOD X6		<p>Logic "1" is normal intensity</p> <p>Logic "0" is blanked</p>	

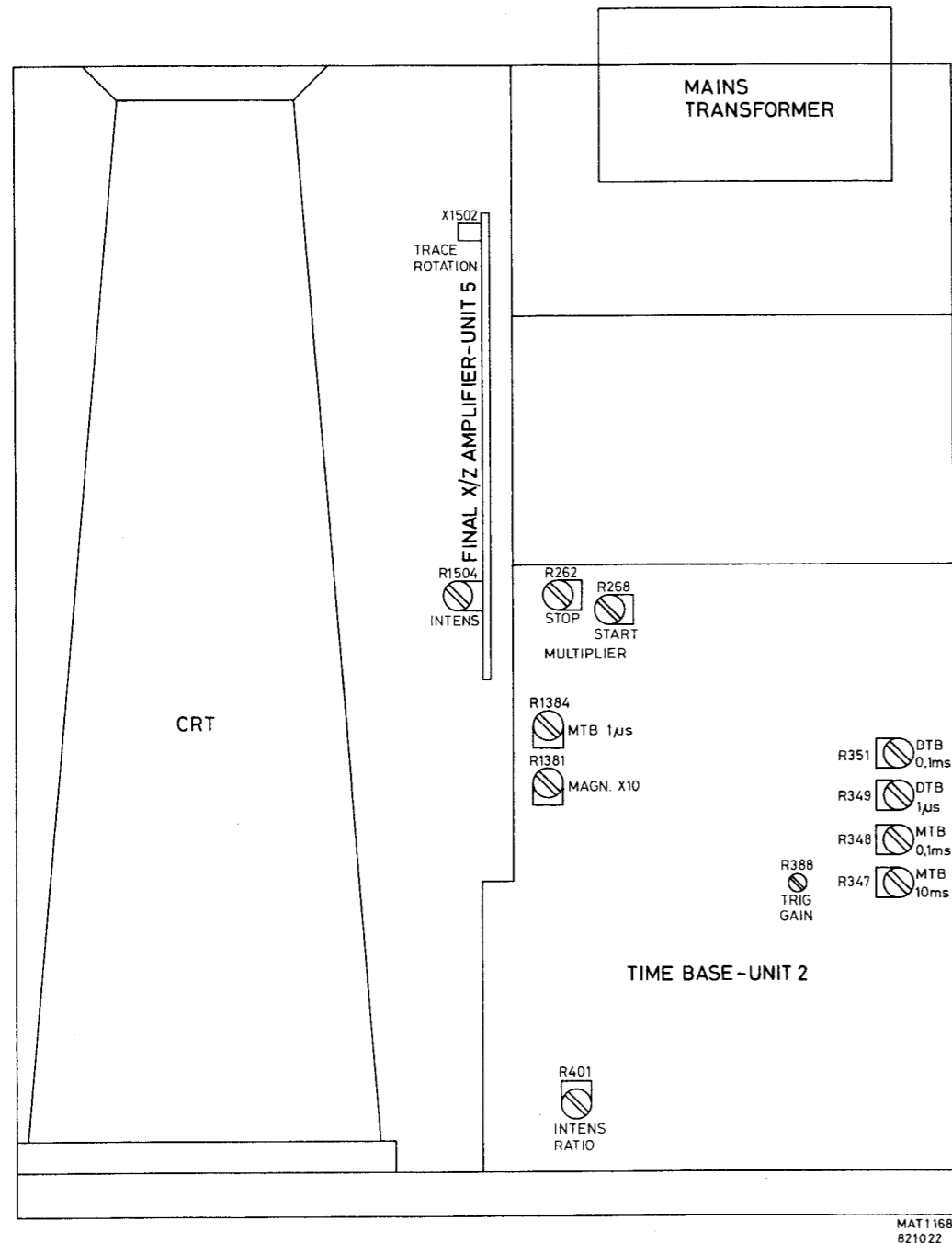

Fig. 5.1. Adjustment points top view

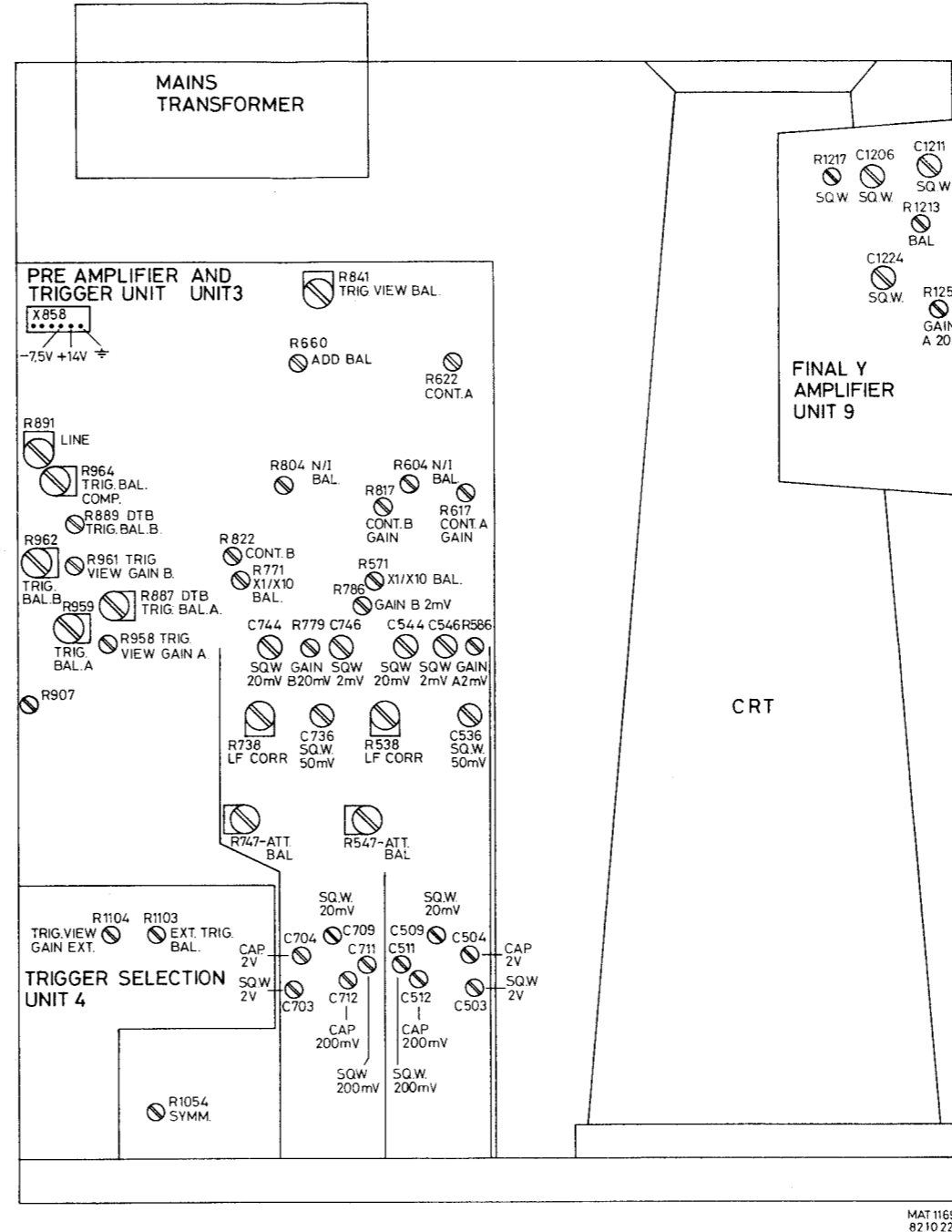

Fig. 5.2. Adjustment points bottom view

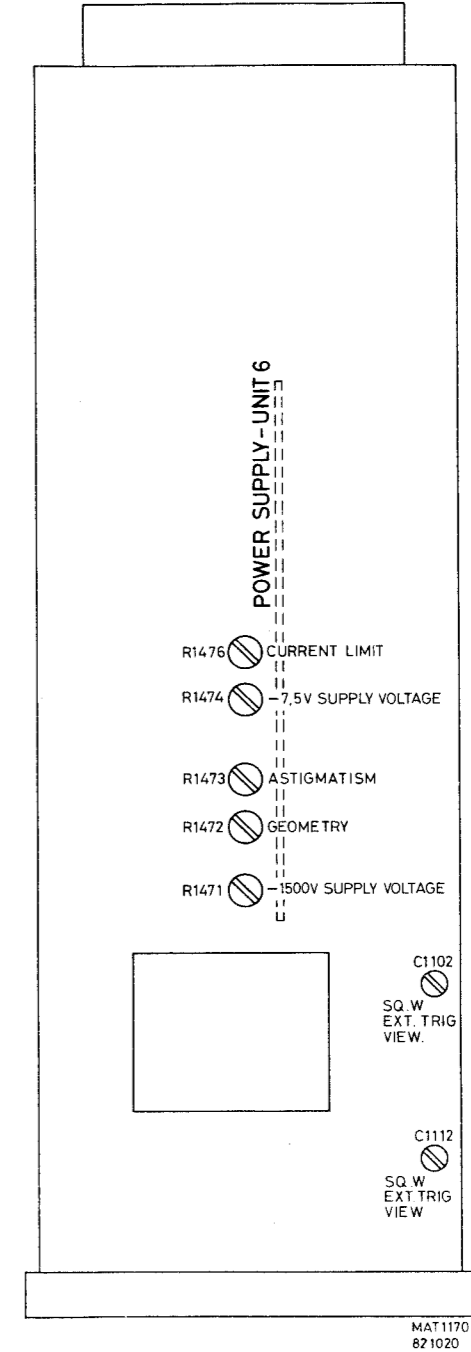
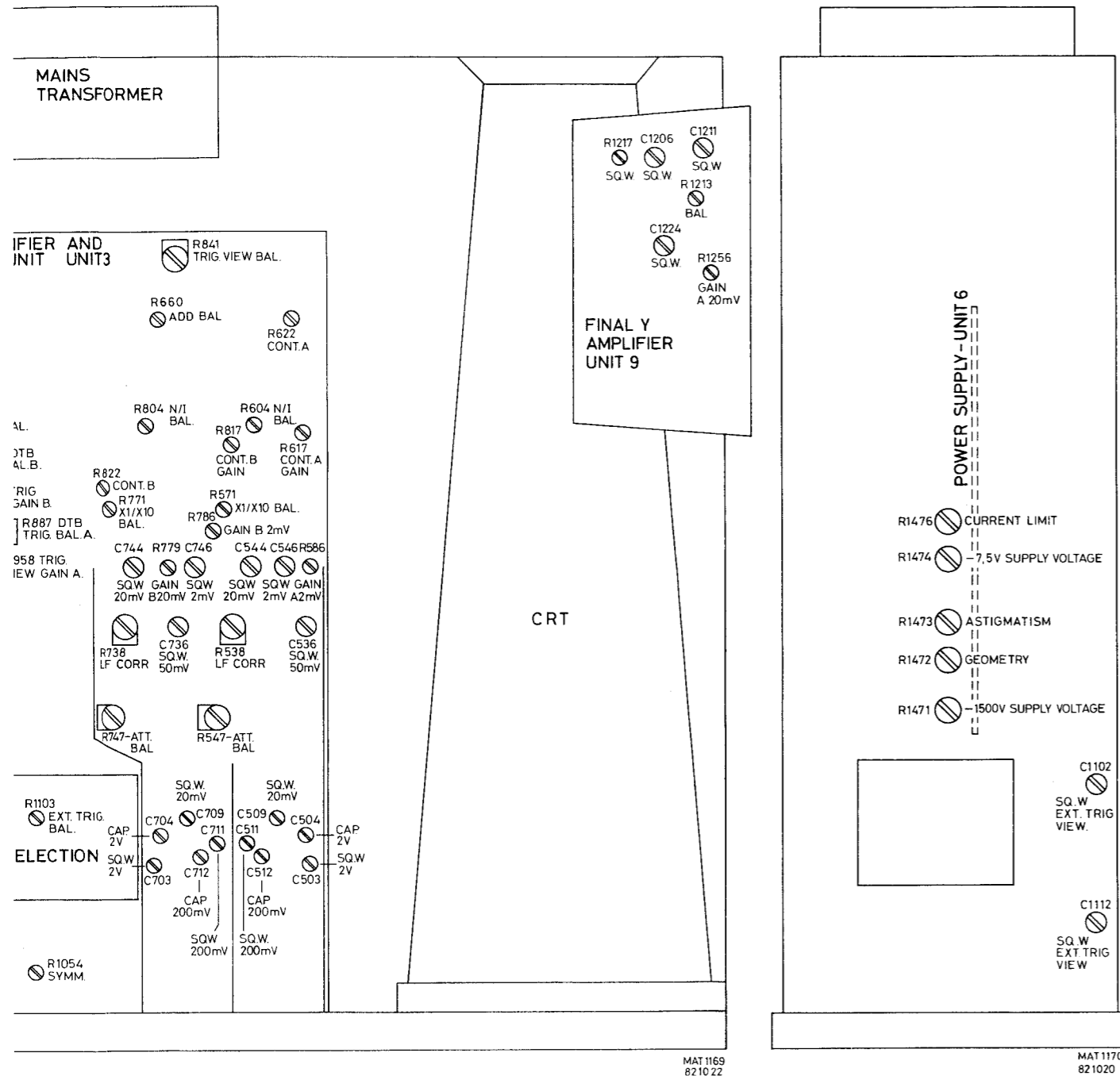

Fig. 5.3. Adjustment points right side



Adjustment points bottom view

Fig. 5.3. Adjustment points right side

5. CHECKING AND ADJUSTING

WARNING: The opening of covers or removal of parts, except those to which access can be gained by hand, is likely to expose live parts, and also accessible terminals may be live. The instrument shall be disconnected from all voltage sources before any adjustment, replacement or maintenance and repair during which the instrument will be opened. If afterwards any adjustment, maintenance or repair of the opened instrument under voltage is inevitable, it shall be carried out only by a qualified person who is aware of the hazard involved. Bear in mind that capacitors inside the instrument may still be charged even if the instrument has been separated from all voltage sources.

5.1. General Information

The following information provides the complete checking and adjusting procedure for the oscilloscope. As various control functions are interdependent, a certain order of adjustment is often necessary. The procedure is, therefore, presented in a sequence which is best suited to this order, cross-reference being made to any circuit which may affect a particular adjustment. Before any check or adjustment, the instrument must attain its normal operating temperature.

- Where possible, instrument performance is checked before an adjustment is made.
- Warming-up time under average conditions is 30 minutes.
- All limits and tolerances given in this section are calibration guides and should not be interpreted as instrument specifications unless they are also published in chapter 1. characteristics.
- Tolerances given are for the instrument under test and do not include test equipment error.
- The most accurate display adjustments are made with a stable, well-focused, low-intensity display. Unless otherwise stated, adjust the Intensity, Focus and Trigger Level controls as needed.
- Unless otherwise stated, the controls occupy the same position as in the previous check.

5.2. Recommended test equipment

As indicated in chapter 4.3. Additional equipment for the checking and adjusting procedure:

Digital multimeter	e.g. PM 2522 (A) or PM 2524
H.T. probe	e.g. PM 9246
Trimming tool set	e.g. Philips 800NTX
Resistor 130 Ω, 1,5 W	e.g. 120 Ω WR (4822 112 21083) in serial with 10 Ω WR (4822 112 51054)

5.3. Preliminary settings of the controls

See Fig. 4.1.

5.4. SURVEY OF ADJUSTING ELEMENTS AND AUXILIARY EQUIPMENT

ADJUSTMENT	ADJUSTING ELEMENT	ADJUSTING RESULT	RECOMMENDED INSTRUMENT AND INPUT SIGNALS	CHAPTER	FIGURES
POWER SUPPLY					
Supply voltage adjustment	R1474	- 7.5V + or - 3 ^o /oo on pin 3 of X858	Digital multimeter	5.5.1.1.	5.2./5.3.
Current sensing	R1476	Extra load between pin 2 (+14V) and pin 1 of X858. Adjust so that current limit point is just not reached.	—	5.5.1.2.	5.3.
-1500V supply voltage	R1471	-1500V + or -3 ^o /oo on pins 7 and 14 of the c.r.t. socket.	Digital multimeter and HV probe	5.5.1.3.	5.3.
CRT DISPLAY ADJUSTMENTS					
Intensity	R1504	Point is just visible	—	5.5.2.1.	5.1.
Intens ratio	R401	DTB-trace must be well distinguished from MTB-trace	—	5.5.2.2.	5.1.
Trace rotation	R14	Trace runs exactly in parallel with the horizontal graticule line	—	5.5.2.3.	4.1.
Astigmatism	R1473	Trace as sharp as possible	Function generator (sine-wave signal 10kHz)	5.5.2.4.	5.3.
Geometry	R1472	Displayed vertical lines as straight as possible and signal must fall between hatched area shown in Fig. 5.4.	Function generator (sine-wave signal 100kHz and ≈ 50Hz)	5.5.2.5.	5.3./5.4.
BALANCE ADJUSTMENTS					
Attenuator balance channel A (B)	R547 (R747)	Trace jump minimal (AMPL/DIV setting 2mV and 5mV)	—	5.5.3.1.	5.2.
	R571 (R771)	Trace jump minimal (AMPL/DIV setting 10mV and 20mV)	—	5.5.3.1.	5.2.
Normal-Invert balance channel A (B)	R604 (R804)	Trace jump minimal	—	5.5.3.2.	5.2.
Final Y-amplifier balance	R1213	Trace in vertical mid of screen	—	5.5.3.3.	5.2.
Added balance	R660	Trace jump minimal when switching to added.			

ADJUSTMENT	ADJUSTING ELEMENT	ADJUSTING RESULT	RECOMMENDED INSTRUMENT AND INPUT SIGNALS	CHAPTER	FIGURES	
LF CORRECTIONS AND SENSITIVITIES						
Continuous control of channel A (B)	R622 (R822)	Continuous attenuation starts at 15° from counter clockwise-stop of R7 (R8)	Function generator (square-wave signal 10kHz)	5.5.4.1.	5.2.	
	R617 (R817)	Trace height from 5 div. to ≤ 2 div. when R7 (R8) are fully counter clockwise.	Function generator (square-wave signal 10kHz)	5.5.4.1.	5.2.	
LF correction of channel A (B)	R538 (R738)	Pulse top as straight as possible	Function generator (square-wave signal 100kHz)	5.5.4.2.	5.2.	
Gain x 1 channel A (B)	R1256 (R779)	Trace height 5 div. + or -3%	Calibration generator (square-wave signal 10kHz)	5.5.4.3.	5.2.	
Gain x10 channel A (B)	R586 (R786)	Trace height 5 div. + or - 3%	Calibration generator (square-wave signal 10kHz)	5.5.4.4.	5.2.	
Trigger view sensitivity EXT, A and B	R1104 R958 (A) R961 (B)	Trace height 4 div.	Calibration generator (square-wave signal 10kHz)	5.5.4.5.	5.2.	
VERTICAL CHANNELS						
Attenuator square-wave response channel A (B)		Pulse top errors ≤ + or -1%	Square-wave generator,	5.5.5.1.	5.2.	
		AMPL/DIV switch setting Trace height	Freq. 10kHz amplitude:			
		2-5-10mV	12mV-30mV-60mV			
	C509 (C709)	20 mV	6 div.			120mV
		50 mV	6 div.			300mV
	C511 (C711)	0.1 V	6 div.			600mV
		0.2 V	6 div.			1.2V
		0.5 V	6 div.			3 V
		1 V	6 div.			6 V
	C503 (C703)	2 V	6 div.			12 V
5 V		3 div.	15 V			
10 V		3 div.	30 V			

ADJUSTMENT	ADJUSTING ELEMENT	ADJUSTING RESULT	RECOMMENDED INSTRUMENT AND INPUT SIGNALS	CHAPTER	FIGURES
Input capacitance channel A (B)	Adjust C of dummy C512 (C712) C504 (C704)	Pulse top errors $\leq +$ or $- 1\%$ AMPL/DIV setting Trace height 2 mV 6 div. 5 mV 6 div. 10 mV 6 div. 20 mV 6 div. 50 mV 6 div. 0.1 V 6 div. 0.2 V 6 div. 0.5 V 6 div. 1 V 6 div. 2 V 6 div. 5 V 3 div. 10 V 1.5 div.	Square-wave generator. rise-time $\leq 100\text{ns}$, via dummy-probe 2 : 1 (fig. 5.5.) Freq. 10kHz Amplitude 24 mV 60 mV 120 mV 240 mV 600 mV 1.2 V 2.4 V 6 V 12 V 24 V 30 V 30 V	5.5.5.2.	5.2.
Square-wave response channel A	C1211 C1224 C1206 R1217 C 544 C 536 C 546	AMPL/DIV setting: 20mV 50mV 2mV	Square-wave calibration generator, frequency 1MHz, rise-time $\leq 1\text{ns}$, amplitude: 120mV 300mV 12mV	5.5.5.3.	5.2./5.6.
Square-wave response channel B.	C744 C736 C746	AMPL/DIV setting: 20mV 50mV 2mV	Square-wave calibration generator, frequency 1MHz, rise-time $\leq 1\text{ns}$, amplitude: 120mV 300mV 12mV	5.5.5.4.	5.2./5.6.

ADJUSTMENT	ADJUSTING ELEMENT	ADJUSTING RESULT	RECOMMENDED INSTRUMENT AND INPUT SIGNALS	CHAPTER	FIGURES
Square-wave response trigger view via external trig. input	C1112 C1102		Square-wave function generator, frequency 10kHz, amplitude 2V. Square-wave calibration generator, frequency 1MHz, amplitude 2V, rise-time ≤ 1 ns.	5.5.5.6.	5.3.
TRIGGERING					
Trigger symmetry	R1054	The distances between the trigger points and the top respectively the bottom of the sine-wave signal must be equal.	Sine-wave signal, 10kHz, ampl. 0.8V.	5.5.6.1.	5.2.
Trigger sensitivity	R388	Push and pull S8; trace must be triggered at trace height of 0.4 div.	Sine-wave signal, 10kHz, ampl. 0.8V.	5.5.6.2.	5.1.
Trigger balance channel A, B and EXT	R959 R962 R1103	Trace in vertical centre Trace in the vertical centre Trace in the vertical centre	— — —	5.5.6.3. 5.5.6.3.	5.2. 5.2.
Composite balance	R964	Starting point of trace does not shift when switching to DC trigger coupling	Sine-wave signal, 10kHz, ampl. 0.8V	5.5.6.4.	5.2.
Trigger view balance	R841	Trace in the vertical centre	—	5.5.6.5.	5.2.
Trigger balance	R887 (A)	Start of trace on the vertical centre line	Sine-wave signal, 10kHz	5.5.6.6.	5.2.
DTB via A and B	R889 (B)	Start of trace on the vertical centre line	Sine-wave signal, 10kHz	5.5.6.6.	5.2.

ADJUSTMENT	ADJUSTING ELEMENT	ADJUSTING RESULT	RECOMMENDED INSTRUMENT AND INPUT SIGNALS	CHAPTER	FIGURES
TIME-BASE GENERATORS Main-time-base time coefficients		Check that the centre 8 cycles have a total width of 8 div. MTB TIME/DIV	Time-marker generator, pulse repetition rate:	5.5.7.1.	
	R1384	0.05 μ s horizont. lin. of first three cycles	0.05 μ s		
	R1381	0.1 μ s	0.1 μ s		5.1.
		0.2 μ s	0.2 μ s		5.1.
		0.5 μ s	0.5 μ s		
		1 μ s	1 μ s		
		1 μ s	0.1 μ s		
		Pull X MAGN switch			
		2 μ s	2 μ s		
		5 μ s	5 μ s		
		10 μ s	10 μ s		
		20 μ s	20 μ s		
		50 μ s	50 μ s		
	R348	0.1 ms	0.1 ms		5.1.
		0.2 ms	0.2 ms		
		0.5 ms	0.5 ms		
		1 ms	1 ms		
		2 ms	2 ms		
		5 ms	5 ms		
	R347	10 ms	10 ms		5.1.
		20 ms	20 ms		
		50 ms	50 ms		
		1 s	1 s		
		2 s	2 s		
		5 s	5 s		
		Continuous control range of R10 must be between 1 : 2.6 and 1 : 3			

ADJUSTMENT	ADJUSTING ELEMENT	ADJUSTING RESULT	RECOMMENDED INSTRUMENT AND INPUT SIGNALS	CHAPTER	FIGURES
Delayed time-base time coefficients	R349	Check that the centre 8 cycles have a total width of 8 div.	Time-marker generator, pulse repetition rate: 0.05 μ s 0.1 μ s 0.2 μ s 0.5 μ s 1 μ s 2 μ s 5 μ s 10 μ s 20 μ s 50 μ s	5.5.7.4.	5.1.
		MTB TIME/DIV. DTB TIME/DIV.			
0.1 μ s 0.05 μ s					
0.2 μ s 0.1 μ s					
0.5 μ s 0.2 μ s					
1 μ s 0.5 μ s					
2 μ s 1 μ s					
5 μ s 2 μ s					
10 μ s 5 μ s					
20 μ s 10 μ s					
50 μ s 20 μ s					
R351	0.1 ms 50 μ s				
	0.2 ms 0.1 ms				
	0.5 ms 0.2 ms				
	1 ms 0.5 ms				
	2 ms 1 ms				
Delay time multiplier	R268	Continuous control range of R9 must be between 1 : 2.6 and 1 : 3	Time-marker generator pulse repetition rate 0.1ms.	5.5.7.5.	5.1.
	R262	Start of DTB trace on the second time-marker pulse when DELAY TIME control is set to 0.1			
X-DEFLECTION	R891	Start of DTB trace on the tenth time-marker pulse when DELAY TIME control is set to 9.0	Time-marker generator pulse repetition rate 0.1ms	5.5.7.5.	5.1.
		Line mode via X DEFL	Trace width must be 8 div.	5.5.8.1.	5.2.

5.5. ADJUSTING PROCEDURE

The adjusting elements are indicated in fig. 5.1., 5.2. and 5.3. for respectively top, bottom and right-hand side of the instrument.

5.5.1. Power supply

- Check that the voltage selector (S25) has been set to the local mains voltage.
- Connect the instrument to the mains voltage or to a 24V battery supply.
- Switch on the oscilloscope and check that the pilot lamp B5 lights up.
- Check that the power consumption (with graticule illumination on) does not exceed 45W from AC and 37W from a battery supply.

5.5.1.1. Supply voltage adjustment

- Check at nominal mains voltage or battery supply voltage that the voltage on pin 3 of X858 (see fig. 5.2.) is $-7.5V \pm 0.3\%$; if necessary readjust R1474 (fig. 5.3.).

5.5.1.2. Current sensing

- Connect a resistor of 130Ω (1.5W) across pin 2 (+14V) and pin 1 (\perp) of X858 (fig. 5.2.).
- Adjust the maximum current by means of R1476 (fig. 5.3.), so that the current limit point is just not reached.
- Remove the resistor.

5.5.1.3. $-1500V$ supply voltage

- Check the $-1500V$ supply voltage on pins 7 and 14 of the c.r.t. socket.
This $-1500V$ must be $\pm 0.3\%$; if necessary readjust R1471 (fig. 5.3.).

5.5.2. CRT display adjustments

5.5.2.1. Intensity

- Set the controls as indicated in fig. 4.1.
- Turn R401 (fig. 5.1.) fully to the left.
- Depress X DEF L of S2.
- Set the displayed point in the vertical and horizontal centre of the screen by means of the Y position R1 and the X pos. R5 controls.
- Depress 0 of S17.
- Turn the INTENS control R12 45° from the left hand stop.
- Check that the point is just visible; if necessary readjust R1504 (fig. 5.1.).

5.5.2.2. Intens ratio

- Depress MTB of S2.
- Depress DC of S17.
- Set the MTB TIME/DIV switch S15 to $5\mu s$.
- Set the DTB TIME/DIV switch S13 to $1\mu s$.
- Set the DELAY TIME control R3 to 5.0.
- Set the INTENS control R12 so that the MTB trace is barely visible over the entire screen.
- Check that the intensified part (DTB part) is more brilliant and can be well distinguished from the MTB trace; if necessary readjust R401 (fig. 5.1.).
- Set the DTB TIME/DIV S13 to OFF.
- If necessary readjust intensity adjustment R1504 (see chapter 5.5.2.1.).

5.5.2.3. Trace rotation

- Set the MTB TIME/DIV S15 to 0.1ms.
- Set the trace in the vertical centre of the screen by means of the POSITION control R1.
- Check that the trace runs exactly in parallel with the horizontal graticule line; if necessary readjust TRACE ROTATION R14 (front panel).

NOTE: If the adjustment range is not sufficient enough, remove connector X1502 (FINAL X/Z AMPLIFIER Unit 5), turn it 180° and reconnect it.
After that, repeat the procedure described above.

5.5.2.4. Focus and astigmatism

- Set the AMPL/DIV switch S9 to 0.1V.
- Depress 0 of S18.
- Set the MTB TIME/DIV switch S15 to 20 μ s.
- Depress ALT of S1.
- Set the trace of channel B in the vertical centre of the screen by means of the POSITION control R2.
- Set the FOCUS control R13 135^o from its left hand stop.
- Apply a sine-wave signal, frequency 10kHz, 6 div, trace height to input A.
- Check that the traces are as sharp as possible; if necessary optimise with the aid of R1473 and small readjustments of R13 (fig. 5.3.).

5.5.2.5. Geometry (barrel and pin-cushion distortion)

- Depress A of S1.
- Set the AMPL/DIV switches S9 and S11 to 0.1V.
- Apply a sine-wave signal, frequency 100kHz, amplitude \approx 800mVp-p to input A.
- Adjust the trace height to 7.4 div. with R7.
- Set the MTB TIME/DIV switch S15 to 50 μ s.
- Apply a sine-wave signal, frequency \approx 50Hz/amplitude \approx 1Vp-p to input B.
- Depress X DEFL of S2.
- Depress B of S23.
- Adjust the horizontal deflection to 9.4 div. by means of the continuous control R8.
- Check that the displayed vertical and horizontal lines are as straight as possible and check that the signal falls between the hatched area shown in fig. 5.4.; if necessary readjust R1472 (fig. 5.3.).
- Remove the input signals.

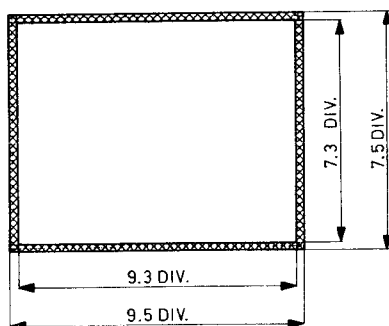

MAT 981 A

Fig. 5.4. Geometry check

5.5.3. Balance adjustments

The balance adjustments of channels A and B are identical.

The knobs, sockets and adjustments of channel B are shown in brackets behind those of channel A.

5.5.3.1. Attenuator AMPL/DIV balance channel A (B)

- Set the controls as indicated in fig. 4.1.
- Depress A (B) of S1.
- Depress 0 of S17 and S18.
- Depress A (B) of S23.
- Set the trace in the vertical centre of the screen by means of POSITION control R1 (R2).
- Switch the AMPL/DIV control S9 (S11) between the positions 2mV and 5mV.
- Adjust R547 (R747) for minimal trace jump, fig. 5.2.
- Switch the AMPL/DIV control S9 (S11) between the positions 10mV and 20mV.
- Adjust R571 (R771) for minimal trace jump, fig. 5.2.

5.5.3.2. Normal-Invert balance channel A (B)

- Depress A (B) of S1.
- Put the AMPL/DIV control S9 (S11) in position 2mV.
- Set the trace in the vertical centre of the screen by means of POSITION control R1 (R2).
- Pull and push the normal-invert switch S4 (S5).
- Adjust R604 (R804) for minimal trace jump, fig. 5.2.

5.5.3.3. Final Y amplifier balance

- Interconnect both inputs of the delay line.
- Adjust R1213 (fig. 5.2.) on the final Y amplifier unit so that the trace is just in the vertical mid of the screen. Disconnect both inputs of the delay-line.
- Depress 0 of S17 and S18.
- Put the AMPL/DIV switches in position 20mV/div.
- Turn the channel A position control R1 fully counter clockwise.
- Turn the channel B position control R2 fully clockwise.
- Depress ADD of S1.
- Position the trace in the vertical mid of the screen by means of R660 (fig. 5.2.).
- Depress ALT of S1.
- Position the channel A and B traces in the vertical mid of the screen by means of R1 and R2.
- Depress ADD of S1 and read out the vertical distance between the trace and the vertical mid of the screen.
- Depress B of S1 and adjust R660 (fig. 5.2.) so that a vertical distance is obtained equal to the one measured in the previous step.
- Check the adjustment as follows: depress ALT of S1 and position the channel A and B traces in the vertical mid of the screen.
- Depress ADD and check if the trace is still in the vertical mid of the screen.

5.5.4. LF corrections and sensitivities

The LF corrections and sensitivity adjustments of channel A and B are identical.

The knobs, sockets and adjustments for channel B are shown in brackets behind those of channel A.

5.5.4.1. Continuous control of channel A (B)

- Depress A (B) of S1.
- Depress A (B) of S23.
- Set the AMPL/DIV switch S9 (S11) to 20mV.
- Apply a square-wave signal, freq. 10kHz, ampl. 100mV approx. to input A (B), giving 5 div. deflection on screen.
- Turn the continuous control CAL R7 (R8) 15° counter clockwise out of its CAL position.
- Check that the continuous attenuation starts at this position of the continuous control; if necessary readjust R622 (R822), fig. 5.2.
- Turn the continuous control CAL R7 (R8) fully counter clockwise.
- Check that the trace height is ≤ 2 div., if necessary readjust R617 (R817), fig. 5.2.

5.5.4.2. LF correction of channel A (B)

- Set the controls as indicated in fig. 4.1.
- Set the MTB TIME/DIV switch S15 to 20ms.
- Set the AMPL/DIV switch S9 (S11) to 20mV.
- Apply a square-wave signal, frequency 100Hz, ampl. 100mV to input A (B).
- Check that the pulse top is as straight as possible; if necessary readjust R538 (R738), fig. 5.2.

NOTE: Check if the AMPL/DIV balance, the normal/invert balance and the final Y amplifier balance are still within tolerance. If not repeat paragraphs 5.5.3.1., 5.5.3.2. and 5.5.3.3.

5.5.4.3. Gain X1 (sensitivity) channel A (B)

- Set the MTB TIME/DIV switch to 0.2ms.
- Apply a square-wave signal, freq. 10kHz, ampl. 100mV to input A (B).
- Set the AMPL/DIV switch S9 (S11) to 20mV.
- Depress A (B) of S1.
- Depress A (B) of S23.
- Check that the trace height is 5 div. + or – 3%; if necessary readjust R1256 (R779), fig. 5.1. (fig. 5.2.).

5.5.4.4. Gain X10 (sensitivity) channel A (B)

- Depress A (B) of S1.
- Depress A (B) of S23.
- Set the AMPL/DIV switch S9 (S11) to 2mV.
- Apply a square-wave signal, freq. 10kHz, ampl. 10mV to input A (B).
- Check that the trace height is 5 div. + or – 3%; if necessary readjust R586 (R786), fig. 5.2.

5.5.4.5. Trigger view sensitivity via EXT and A and B

- Set the controls as indicated in fig. 4.1.
- Set the AMPL/DIV switch S9 (S11) to 0.2mV.
- Apply a square-wave signal, freq. 10kHz, ampl. exactly 0.8V to input EXT (X5) and A and B.
- Apply a square-wave signal, freq. 10kHz, ampl. exactly 2V to input EXT (X5) and A and B.
- Depress TRIG VIEW of S1.
- Depress TRIG and AUTO PP of S3.
- Set the trace in the vertical centre by means of the LEVEL control R6,
- Depress EXT of S23,
- Check that the trace height is 4 div.; if necessary readjust R1104, fig. 5.2.
- Depress A of S23.
- Check that the trace height is exactly 4 div.; if necessary readjust R958, fig. 5.2.
- Depress B of S23.
- Check that the trace height is exactly 4 div.; if necessary readjust R961, fig. 5.2.

5.5.5. Square-wave response and bandwidth

The adjustments of channel A and B are identical.

The item numbers of the knobs, sockets and adjustments of channel B are shown in brackets behind those of channel A.

5.5.5.1. Attenuator square-wave response, channel A (B)

- Set the controls as indicated in fig. 4.1.
- Set the MTB TIME/DIV switch S15 to 20 μ s.
- Apply a square-wave signal freq. 10kHz, rise time \leq 100ns to input A (B).
- Depress A (B) of S1.
- Depress A (B) of S23.
- Check the trace height of the displayed signal (indicated in the table below).
- Check the square-wave response; check that the pulse-top errors do not exceed + or –1%; if necessary readjust as indicated in the table below.

Channel A (B) AMPL/DIV S9 (S11)	Amplitude of input signal A (B)	Adjusting element channel A (B)	Trace height + or –1%
2 mV	12 mV		6 div.
5 mV	30 mV		6 div.
10 mV	60 mV		6 div.
20 mV	120 mV		6 div.
50 mV	300 mV	C509 (C709)	6 div.
0.1 V	600 mV		6 div.
0.2 V	1.2 V		6 div.
0.5 V	3 V	C511 (C711)	6 div.
1 V	6 V		6 div.
2 V	12 V		6 div.
5 V	15 V	C503 (C703)	3 div.
10 V	30 V		3 div.
see fig. 5.2.			

- Remove the input signal

5.5.5.2. Input capacitance, channel A (B)

- Apply via a dummy probe (fig. 5.5.) a square-wave signal, freq. 10kHz, rise-time $\leq 100\text{ns}$ to input A (B).
- Check the square-wave response; check that the pulse top errors do not exceed + or - 1% ; if necessary readjust as indicated in the table below.
- Check the amplitude of the displayed signal.

Channel A (B) AMPL/DIV S9 (S11)	Amplitude of input signal A (B)	Adjusting element channel A (B)	Trace height + or -1%
2 mV	24 mV	-	6 div.
5 mV	60 mV	-	6 div.
10 mV	120mV	-	6 div.
20 mV	240 mV	Adjust Cd (dummy)	6 div.
50 mV	600 mV	-	6 div.
0.1 V	1.2 V	-	6 div.
0.2 V	2.4 V	C512 (C712)	6 div.
0.5 V	6 V	-	6 div.
1 V	12 V	-	6 div.
2 V	24 V	C504 (C704)	6 div.
5 V	30 V		3 div.
10 V	30 V		1.5 div.

Fig. 5.5. Dummy probe 2 : 1

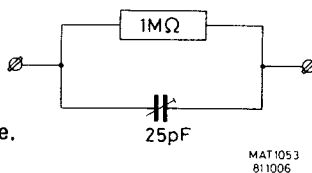

- Remove input signal and dummy probe.

5.5.5.3. HF square-wave response channel A

- Set the controls as indicated in fig. 4.1.
- Set the AMPL/DIV switch S9 to 20mV.
- Apply to X2 (A) a square-wave signal at 120mV, frequency 1MHz and with a rise-time $\leq 1\text{ns}$.
- Set the TIME/DIV switch S15 to 0.2 μs .
- Using C1211 and C1244 (fig. 5.2.) adjust the square-wave response as straight as possible (see fig. 5.6.).

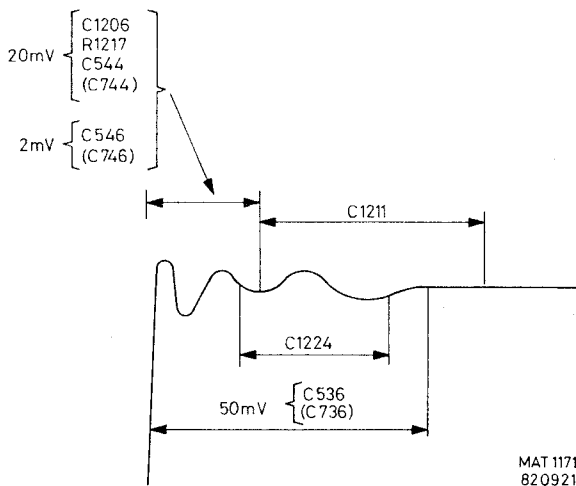

Fig. 5.6. Adjustment of HF square-wave response

- Set the TIME/DIV switch S15 to 0.1 μ s.
- Using C1206, R1217 and C544 (fig. 5.2.) adjust the square-wave response as straight as possible (fig. 5.6.).
- Set the AMPL/DIV switch S9 to 50mV.
- Apply to X2 (A) a square-wave signal of 300mV, frequency 1MHz and with a rise-time \leq 1ns.
- Using C536 (fig. 5.2.) adjust the square-wave response as straight as possible (see fig. 5.6.).
- Set the AMPL/DIV switch S9 to 2mV.
- Apply (via a 20dB attenuator, if generator output voltage is too high) to X2 (A) a square-wave signal of 12mV, frequency 1MHz and with a rise-time \leq 1ns.
- Using C546 (fig. 5.2.) adjust the square-wave response as straight as possible (fig. 5.6.).
- Check the bandwidth according to paragraph 5.5.5.8.

5.5.5.4. HF square-wave response channel B

- Set the controls as indicated in fig. 4.1.
- Set the AMPL/DIV switch S11 to 20mV.
- Apply to X4 (B) a square-wave signal of 120mV, frequency 1MHz and with a rise-time \leq 1ns.
- Set the TIME/DIV switch S15 to 0.1 μ s.
- Using C744 (fig. 5.2.) adjust the square-wave response as straight as possible (fig. 5.6.).
- Set the AMPL/DIV switch S11 to 50mV.
- Apply to X4 (B) a square-wave signal of 300mV, frequency 1MHz and with a rise-time \leq 1ns.
- Using C736 (fig. 5.2.) adjust the square-wave response as straight as possible (see fig. 5.6.).
- Set the AMPL/DIV switch S11 to 2mV.
- Apply to X4 (B) a square-wave signal of 12mV, frequency 1MHz and with a rise-time \leq 1ns (via a 20dB attenuator, if generator output voltage is too high).
- Adjust with C746 (fig. 5.2.) the square-wave response as straight as possible (fig. 5.6.).
- Check the bandwidth according to paragraph 5.5.5.8.

5.5.5.5. Square-wave response channel A (B) invert

- Depress A (B) of S1.
- Depress A (B) of S23.
- Pull the NORMAL-INVERT switch S4 (S5).
- Apply a square-wave signal, frequency 1MHz, rise-time \leq 1ns to input A (B).
- Check the square-wave response of the inverted signal; if necessary readjust for an optimal result between NORMAL square-wave and INVERTed square-wave by means of the procedure given in section 5.5.5.3. and 5.5.5.4.

5.5.5.6. Square-wave response Trigger view via external trigger input and channel A and B

- Set the MTB TIME/DIV switch S15 to 20 μ s.
- Depress TRIG VIEW of S1.
- Apply a square-wave signal, freq. 10kHz, amplitude 0.8V to input EXT (X5).
- Depress EXT of S23.
- Depress TRIG of S3.
- Set the trace in the vertical centre of the screen by means of the LEVEL control R6.
- Check that the pulse top is as straight as possible; if necessary readjust C1112 (fig. 5.3.).
- Increase the frequency of the input signal to 1MHz, rise-time \leq 1ns, amplitude 0.8V.
- Set the MTB TIME/DIV switch S15 to 0.2 μ s.
- Adjust C1102 (fig. 5.3.) so that the overshoot and aberrations of the trigger view signal do not exceed 6% (0% p.p).
- Remove the input signal.
- Set the AMPL/DIV switch S9 (S11) to 20mV.
- Depress A (B) of S23.
- Apply a square-wave signal, freq. 1MHz, rise-time \leq 1ns, amplitude 120mV to input A (B).
- Set the trace in the vertical centre of the screen by means of the LEVEL control R6.
- Check that the pulse-aberrations and overshoot do not exceed 10% p.p.

5.5.5.7. Chopper cross-talk from channel A to B

- Set the controls as indicated in fig. 4.1.
- Depress CHOP pushbutton of S1.
- Set the AMPL/DIV switches S9 and S11 to 20mV.
- Apply to X2 (A) a square-wave signal of 120mV, frequency 10kHz and with a rise-time ≤ 1 ns.
- Put the TIME/DIV switch S15 to 0.1ms.
- Check that the cross-talk from channel A to B does not exceed 1.5% (0.1 div.).

5.5.5.8. Bandwidth check channel A (B)

- Depress the X MAGN switch S7 (X1).
- Set the MTB TIME/DIV switch S15 to 5 μ s.
- Apply a sine-wave signal, freq. 50kHz, constant amplitude of 12mV to input A (B).
- Depress A (B) of S1.
- Depress A (B) of S23.
- Set the AMPL/DIV switch S9 (S11) to 2mV.
- Check that the trace height is exactly 6 div.
- Increase the frequency of the input signal from 50kHz to 80MHz (constant amplitude 12mV).
- Check that the trace height is ≥ 4.2 div. over the whole freq. range.
- Set the AMPL/DIV switch S9 (S11) to 20mV.
- Apply a sine-wave signal, freq. 50kHz, constant amplitude of 120mV to input A (B).
- Check that the trace height is exactly 6 div.
- Increase the frequency of the input signal from 50kHz to 100MHz (constant amplitude 120mV).
- Check that the trace height is ≥ 4.2 div. over the whole freq. range.
- If the specifications mentioned above are not met, readjust the instrument according to chapter 5.5.5.3. and 5.5.5.4.

5.5.5.9. Bandwidth check trigger view via channel A (B)

- Set the AMPL/DIV switch S9 (S11) to 2mV.
- Apply a square-wave signal, frequency 50kHz, constant amplitude of 12mV to input A (B).
- Depress A (B) of S23.
- Depress TRIG VIEW of S1.
- Set the trace in the vertical centre of the screen by means of the LEVEL control R6.
- Check that the trace height is exactly 6 div.
- Increase the frequency of the input signal from 50kHz to 60MHz (constant amplitude 12mV).
- Check that the trace height is ≥ 4.2 div.

5.5.5.10. Bandwidth check trigger view via EXT

- Depress EXT of S29.
- Apply a sine-wave signal, freq. 50kHz, constant amplitude 0.8V to input EXT (X5).
- Check that the trace height is exactly 4 div.
- Increase with frequency of the input signal to 70MHz (constant amplitude 0.8V).
- Check that the trace height is ≥ 2.8 div.
- Remove the input signal.
- If the specification mentioned above is not met readjust the instrument according to chapter 5.5.5.6.

5.5.6. Triggering

5.5.6.1. Trigger symmetry

- Set the controls as indicated in fig. 4.1.
- Set S15 to $50\mu\text{s}$.
- Set S9 to .2V.
- Apply a sine-wave signal 1.6V p-p frequency 10kHz to input A.
- Adjust the generator to a trace height of 8 div.
- Push the SLOPE switch S8 for positive triggering.
- Set R6 fully clockwise.
- Note the starting-point of the trace.
- Pull the SLOPE switch S8 for negative triggering.
- Set R6 fully counter-clockwise.
- Note the starting-point of the trace.
- Check that in both situations described above, the distances between the trigger points and the top respectively the bottom of the sine-wave signal are equal; if necessary readjust R1054 (fig. 5.2.) for an optimal result.
- Remove the input signal.

5.5.6.2. Trigger sensitivity

- Set the controls as indicated in fig. 4.1.
- Set S9 and S11 to .2V.
- Apply a sine-wave signal 80mV, frequency 10kHz to the input A.
- Pull and push the SLOPE switch S8.
- Check that the trace is well triggered; if necessary readjust R388 (fig. 5.1.).

5.5.6.3. Trigger balance channel A, B and EXT

- Depress TRIG VIEW of S1.
- Depress AUTO PP and TRIG of S3.
- Depress 0 of S17 and S18.
- Depress LF of S20 and A of S23.
- Set the trace in the vertical centre of the screen by means of the LEVEL control R6.
- Depress DC of S20.
- Check that the trace is in the vertical centre of the screen; if necessary readjust R959 (see fig. 5.2.).
- Depress B of S23.
- Check that the trace is in the vertical centre of the screen; if necessary readjust R962 (see fig. 5.2.).
- Depress EXT of S23.
- Check that the trace is in the vertical centre of the screen; if necessary readjust R1103 (see fig. 5.2.).

5.5.6.4. Composite balance

- Depress A of S1.
- Depress A of S23.
- Depress AUTO (AUTO PP and TRIG) of S3.
- Put AMPL/DIV in position 0.2V.
- Release all the pushbuttons of S20.
- Depress DC of S17.
- Apply a sine-wave signal, frequency 10kHz to input X2 (A).
- Set the trace-height to 4 div.
- Set S15 to $10\mu\text{s}$.
- Depress A and B (COMP) of S23.
- Adjust R964 (fig. 5.2.) so that the starting point of the trace does not shift when switching to position DC of S20.

5.5.6.5. *Trigger view balance*

- Depress TRIG VIEW of S1.
- Depress 0 of S17.
- Depress AUTO PP of S3.
- Depress DC of S20.
- Depress A of S23.
- Check that the trace is in the vertical centre of the screen; if necessary readjust **R841** (see fig. 5.2.).

5.5.6.6. *Trigger balance, DTB, via channel A and B*

- Depress A of S1.
- Set S9 and S11 to 0.2V.
- Set S13 and S15 to 50 μ s.
- Depress A of S22.
- Set the DELAY TIME control R3 fully counter-clockwise (to 0.0).
- Depress DTB of S2.
- Depress DC of S17 and S18.
- Apply a sine-wave signal, frequency 10kHz, amplitude 1.2V to input X2 (A).
- Release all switches of S19.
- Set the trace in the vertical centre of the screen by means of R1.
- Set the start of the trace on the vertical centre line of the screen by means of R4 (LEVEL DTB).
- Depress DC of S19.
- Check that the start of the trace is on the vertical centre line of the screen; if necessary readjust **R887** (fig. 5.2.).
- Depress B of S1.
- Depress B of S22.
- Depress B of S23.
- Apply a sine-wave signal, frequency 10kHz, amplitude 1.2V to input X4 (B).
- Set the trace in the vertical centre of the screen by means of R2.
- Release all switches of S19.
- Set the start of the trace on the vertical centre line of the screen by means of R4.
- Depress DC of S19.
- Check that the start of the trace is on the vertical centre line of the screen; if necessary readjust **R889** (see fig. 5.2.).
- Remove the input signal.

5.5.7. Time-base generators

5.5.7.1. Main time-base time coefficients

- Set the controls as indicated in fig. 4.1.
- Set the AMPL/DIV switch S9 to 0.5V.
- Set the MTB TIME/DIV switch S15 to $1\mu\text{s}$.
- Apply a time-marker signal of $\approx 2\text{V}$, pulse repetition rate $1\mu\text{s}$ to input X2 (A).
- Check that the centre 8 cycles have a total width of 8 div; if necessary readjust R1384 (fig. 5.1.).
- Pull the X MAGN switch S7 (X10).
- Check if the MAGN led B2 lights up.
- Apply a time-marker signal, pulse repetition rate $0.1\mu\text{s}$ to input X2 (A).
- Check that the centre 8 cycles have a total width of 8 div; if necessary readjust R1381 (fig. 5.1.).
- Push the X MAGN switch S7.
- Set the MTB TIME/DIV switch S15 to 0.1ms.
- Apply a time-marker signal, pulse repetition rate 0.1ms, to input X2 (A).
- Check that the centre 8 cycles have a total width of 8 div; if necessary readjust R348 (fig. 5.1.).
- Set the MTB TIME/DIV switch S15 to 10ms.
- Apply a time-marker signal, pulse repetition rate 10ms, to input X2 (A).
- Check that the centre 8 cycles have a total width of 8 div; if necessary readjust R347 (fig.5.1.).
- Check the other positions of the TIME/DIV switch S15, using the appropriate input signals, tolerances $\pm 3\%$.
- Check that the trace-length in all TIME/DIV positions is > 10 div.
- Set the TIME/DIV switch S15 to $1\mu\text{s}$.
- Apply a time-marker signal, pulse repetition rate $1\mu\text{s}$ to input X2 (A).
- Check that the control range of the continuous control R10 lies between 1:2.6 and 1:3.
- Check that the UNCAL led lights up when the continuous control R10 is not in CAL position.
- Set the continuous control R10 in CAL position.

5.5.7.2. X position range

- Set the MTB TIME/DIV switch S15 to 1ms.
- Apply a time-marker signal, pulse repetition rate 10ms, to input A.
- Check that the two displayed marker pulses can be horizontally shifted over a range of 10 div.
- Pull the X MAGN control S7 (X10).
- Check that the two time-marker pulses can be horizontally shifted over a range of 100 div.
- Depress the X MAGN control S7.

5.5.7.3. Hold off

- Set the MTB TIME/DIV switch S15 to $0.1\mu\text{s}$.
- Apply a time-marker signal, pulse repetition rate $10\mu\text{s}$, to input X2 (A).
- Turn the HOLD OFF control R11 counter clockwise.
- Check if the intensity of the displayed signal suddenly decreases.
- Set the TIME/DIV switch S15 to $10\mu\text{s}$.
- Apply a time-marker signal, pulse repetition rate 0.1ms, to input X2 (A).
- Turn the HOLD OFF control control R11 counter clockwise.
- Check if the intensity of the displayed signal suddenly decreases.
- Set the TIME/DIV switch S15 to 5ms.
- Apply a time-marker signal, pulse repetition rate 0.1 sec, to input X2 (A).
- Turn the HOLD OFF control R11 counter clockwise.
- Check if the number of sweeps suddenly decreases (longer HOLD OFF time).
- Set the HOLD OFF control R11 fully clockwise.

5.5.7.4. Delayed time-base time coefficients

- Set the controls as indicated in fig. 4.1.
- Depress A of S22.
- Set the DELAY TIME control R3 to 0.
- Set the MTB TIME/DIV switch S15 to $2\mu\text{s}$.
- Set the DTB TIME/DIV switch S13 to $1\mu\text{s}$.
- Apply a time-marker signal, pulse repetition rate $1\mu\text{s}$, to input X2 (A).
- Depress DTB of S2.
- Check that the centre 8 cycles have a total width of 8 div; if necessary readjust R349 (fig. 5.1.).
- Set the MTB TIME/DIV switch to 0.2ms.
- Set the DTB TIME/DIV switch to 0.1ms.
- Apply a time-marker signal, pulse repetition rate 0.1ms, to input A.
- Check that the centr 8 cycles have a total width of 8 div; if necessary readjust R351 (fig. 5.1.).
- Check the other positions of the DTB TIME/DIV switch S13 (keep the MTB TIME/DIV switch S15 one position slower than the DTB TIME/DIV switch) using the appropriate input signals, tolerances 2.5% (+ or – 1 subdiv.).
- Set the MTB TIME/DIV switch S15 to $5\mu\text{s}$.
- Set the DTB TIME/DIV switch S13 to $1\mu\text{s}$.
- Apply a time-marker signal, pulse repetition rate $1\mu\text{s}$, to input A.
- Check that the control range of the continuous control R9 lies between 1:2,6 and 1:3.
- Check that the UNCAL LED B4 lights up when the continuous control R9 is not in the CAL position.
- Set the continuous control R9 in CAL position.
- Remove the input signal.

5.5.7.5. Delay time multiplier

- Depress MTB of S2.
- Depress MTB of S22.
- Set the DELAY TIME control R3 to 1.0.
- Set the start of the trace exactly on the first vertical graticule line by means of the X POS control R5.
- Set the MTB TIME/DIV switch (S15) to 0.1ms.
- Set the DTB TIME/DIV switch (S13) to $0.1\mu\text{s}$.
- Apply a time-marker signal, pulse repetition rate 0.1ms to input A.
- Check that the intensified part on the trace coincides with the starting point of the second time-marker pulse if necessary readjust R268 (fig. 5.1).
- Set the DELAY TIME control to 9.0.
- Check that the intensified part on the trace coincides with the starting point of the tenth time-marker pulse; if necessary readjust R262 (fig. 5.1.).
- Both adjustments are a little bit interdependent, so the procedure described above must be repeated until both conditions are fulfilled.
- Set the DELAY TIME control R3 to 0.

5.5.7.6. Checking the delay time jitter

- Set the MTB TIME/DIV switch S15 to 1ms.
- Set the DTB TIME/DIV switch S13 to $0.5\mu\text{s}$.
- Apply a sine-wave signal, frequency 1MHz to input X2 (A).
- Set the trace height to 6 div.
- Set the DELAY TIME control to 9.0.
- Depress DTB of S2.
- Check that the jitter of the DTB trace is ≤ 1 div.

5.5.8. X Deflection

5.5.8.1. Adjusting the LINE mode via X DEFL

- Connect the instrument to a mains voltage with a mains frequency of 50Hz.
- Depress B and EXT (LINE) of S23.
- Check that the trace width is 8 div; if necessary readjust R891 (fig. 5.2.).

5.6. ADJUSTMENT INTERACTIONS

This table shows you what adjustment points are affected (see horizontal row) after readjustment of a certain adjustment point in the vertical row.
 The adjustment points that are affected may also need readjustment.

ADJUSTMENT MADE	ADJUSTMENTS AFFECTED
POWER SUPPLY	
Output voltage - R1474	Output voltage - R1474
Current sens. - R1476	Current sens. - R1476
-1500V - R1471	-1500V - R1471
CRT SECTION	
Intensity - R1504	Intensity - R1504
Intens ratio - R401	Intens ratio - R401
Trace rotate - R14	Trace rotate - R14
Astigmatism - R1473	Astigmatism - R1473
Geometry - R1472	Geometry - R1472
BALANCE ADJUSTMENTS	
LF correction - R538/R738	LF correction - R538/R738
Atten. bal. - R547/R747	Atten. bal. - R547/R747
X1/X10 bal. - R571/R771	X1/X10 bal. - R571/R771
Norm./inv. - R604/R804	Norm./inv. - R604/R804
Add. bal. - R660	Add. bal. - R660
Final Y bal. - R1213	Final Y bal. - R1213
LF CORRECTIONS AND SENSITIVITIES	
Cont. control - R622/R822	Cont. control - R622/R822
Cont. control - R617/R817	Cont. control - R617/R817
Cont. control - R1256	Cont. control - R1256
Gain X1 - R779	Gain X1 - R779
Gain X10 - R586/R786	Gain X10 - R586/R786
Trig. view sens. - R1104	Trig. view sens. - R1104
R958, R961	R958, R961
VERTICAL CHANNELS	
Sq. wave 20mV - C509/C709	Sq. wave 20mV - C509/C709
Sq. wave 0.2V - C511/C711	Sq. wave 0.2V - C511/C711
Sq. wave 2V - C503/C703	Sq. wave 2V - C503/C703
Input cap. 0.2V - C512/C712	Input cap. 0.2V - C512/C712
Input cap. 2V - C504/C704	Input cap. 2V - C504/C704
Sq. wave 20mV - C1211, C1224, C1206, R1217, C544/C744	Sq. wave 20mV - C1211, C1224, C1206, R1217, C544/C744
Sq. wave 50mV - C536/C736	Sq. wave 50mV - C536/C736
Sq. wave 2mV - C546/C746	Sq. wave 2mV - C546/C746
Trig. view sq. wave - C1112, C1102	Trig. view sq. wave - C1112, C1102
TRIGGERING	
Trig. symm. - R1504	Trig. symm. - R1504
Trig. sens. - R388	Trig. sens. - R388
Trig. bal. MTB - R959, R962, R964, R1103	Trig. bal. MTB - R959, R962, R964, R1103
Trig. view bal. - R841	Trig. view bal. - R841
Trig. bal. DTB - R887, R889	Trig. bal. DTB - R887, R889
TIME BASE GENERATORS	
MTB - R1384, R1381, R348, R347	MTB - R1384, R1381, R348, R347
DTB - R349, R351	DTB - R349, R351
Delay-time - R268, R262	Delay-time - R268, R262
X-DEFLECTION	
Line via X-defl. - R891	Line via X-defl. - R891

6. CORRECTIVE MAINTENANCE

WARNING: The opening of covers or removal of parts, except those to which access can be gained by hand, is likely to expose live parts, and also accessible terminals may be live. The instrument shall be disconnected from all voltage sources before any adjustment, replacement or maintenance and repair during which the instrument will be opened. If afterwards any adjustment, maintenance or repair of the opened instrument under voltage is inevitable, it shall be carried out only by a qualified person who is aware of the hazard involved. Bear in mind that capacitors inside the instrument may still be charged even if the instrument has been separated from all voltage sources.

6.1. IMPORTANT NOTES

Damage may result if the instrument is switched on when a printed circuit board has been removed, or if a circuit board is removed within one minute after switching off the instrument. How to open the instrument is outlined in chapter 3. "Dismantling the instrument".

WARNING: The EHT-cable is unbreakably connected to the EHT multiplier unit. The cable can be disconnected from the CRT. When the EHT-cable is disconnected from the CRT the end of the cable must be discharged immediately by shorting it to the instrument's earth.

6.2. REPLACEMENTS

6.2.1. Standard parts

Electrical and mechanical part replacements can be obtained through your local Philips organisation or representative. However, many of the standard electronic components can be obtained from other local suppliers.

Before purchasing or ordering replacement parts, check the parts list for value tolerance, rating and description.

NOTE: Physical size and shape of a component may affect instrument performance, particularly at high frequencies. Always use direct-replacement components, unless it is known that a substitute will not degrade the instrument's performance.

6.2.2. Special parts

In addition to the standard electronic components, some special components are used. These components are manufactured or selected by Philips to meet specific performance requirements.

6.2.3. Transistors and integrated circuits

Transistors and IC's (integrated circuits) should not be replaced unless they are actually defective. If removed from their sockets during routine maintenance return them to their original sockets. Unnecessary replacement or switching of semiconductor devices may affect the calibration of the instrument. When a transistor is replaced, check the operation of the part of the instrument that may be affected.

Any replacement component should be of the original type or a direct replacement. Bend the leads to fit the socket and cut the leads to the same length as on the component being replaced.

WARNING: Silicone grease is used to facilitate the conduction of heat between power transistors and their heatsink (for instance on the power supply unit). Handle silicone grease with care. Avoid getting silicone grease in the eyes. Wash hands thoroughly after use.

6.2.4. Replacing knobs (see fig. 6.1.)

Single knobs and delay time multiplier knob

- Prise off cap A.
- Slecken screw (or nut) B.
- Pull the knob from the spindle.

Double knobs

- Prise off cap A and slacken screw B.
- Pull the inner knob from the spindle.
- Slacken nut C and pull the outer knob from the spindle.

When fitting a knob or cap, ensure that the spindle is in a position which allows reference lines to be coincident with the markings on the text plate of the oscilloscope.

When fitting the delay-time multiplier knob, turn the spindle of the potentiometer fully anti-clockwise, so that it occupies the "0" position. Adjust the knob so that its dial also occupies the "0" position and slide it on the potentiometer shaft: when doing this, take care that the stud of the knob fits correctly in the hole that is present in the front panel. After this screw B can be tightened again.

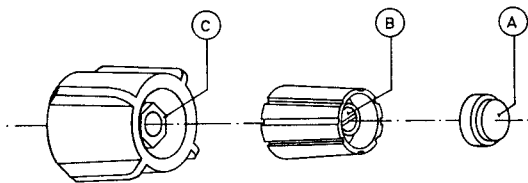

MAT 163

Fig. 6.1. Removing the knobs.

6.2.5. Removing the carrying handle

- Prise off the centre knobs from each pivot, using a screwdriver (Fig. 6.2.) in one of the small slots at the sides of the knobs.
- Remove the cross-slotted screws that are now accessible.
- Bend both arms of the handle slightly outwards and take it off the cabinet.
- Grip and arms of the carrying handle must be ordered separately (see list of mechanical parts). A complete carrying handle can easily be constructed by pressing the arms into the grip.

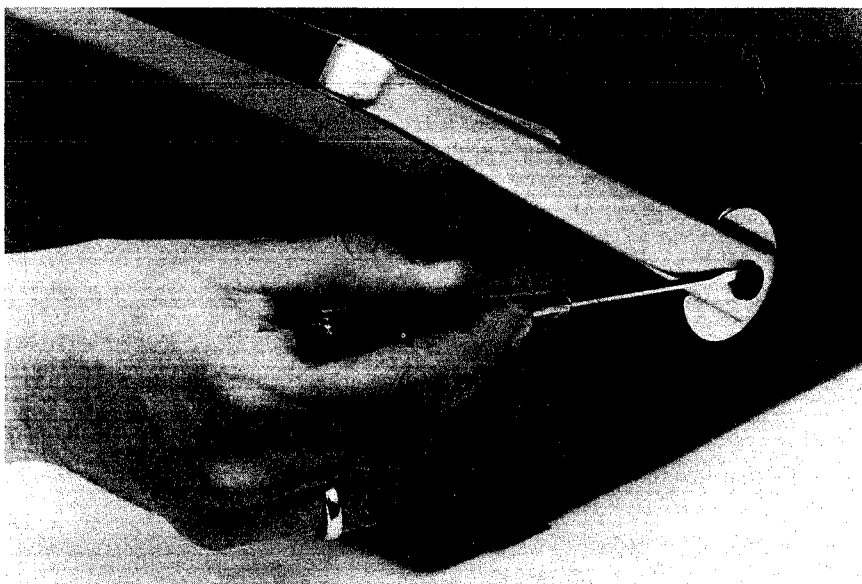

MAT 536

Fig. 6.2. Removal of centre knobs from carrying handle

6.2.6. Replacing the cathode ray tube (CRT)

WARNING: Handle the CRT carefully. Rough handling or scratching can cause the CRT to implode. In particular be very careful with the side connections of the CRT. If these pins are bent the CRT is likely to develop a loss of vacuum.

- Remove the five side connections from the CRT.
- Unscrew the bracelet that secures the CRT in its rubber socket.
- Unplug the EHT-cable from the CRT.

WARNING: The EHT-cable is unbreakably connected to the EHT multiplier unit. The cable can be disconnected from the CRT. When the EHT-cable is disconnected from the CRT the end of the cable must be discharged immediately by shorting it to the instruments earth.

- Unplug the trace rotation cable from the X/Z final amplifier unit (3-pole connector).
- Remove the top support of the CRT screen that carries the graticule illumination lamps.
- Remove the screen bezel and contrast filter as indicated in section 5.3. of the operating manual.
- Remove the CRT socket.
- Carefully pull the CRT from the instrument through the front profile.
- After removing the two star screws that secure the rubber CRT support to the rear panel, remove the CRT shield.

IMPORTANT: When remounting the CRT shield, the rubber CRT support or the CRT itself follow the procedure in reversed sequence and take care that the CRT is pushed properly against the contrast filter in the front profile before fixing the bracelet.

6.2.7. Removing the printed circuit boards

6.2.7.1. Removing the trigger source unit (see fig. 6.5.A)

- Remove 2 screws in the unit.
- Remove 1 screw that secures the unit to the right chassis plate.
- Unplug 1 multipole connector.
- Unplug 2 coaxial connectors.
- Unplug one single pole connector.
- Slide the unit out of the front panel.

6.2.7.2. Removal of pre-amplifier and trigger unit

- Remove the trigger source unit as indicated in chapter 6.2.7.1. (see also fig. 6.5.A).
- Unplug the inputs of the delay-line cable and unscrew the attachment bracket.
- Unplug 3 coaxial connectors.
- Unplug 3 multipole connectors. One of them is a so called bottom-entry, that is attainable via a square hole in the right-hand chassis plate.
- Remove the 2 screws in the pushbutton switches that secure the unit to the front panel.
- Remove the metal screening plate from the attenuator part. This plate is attached by means of 6 selftapping screws (see also fig. 6.5.B).
- Remove the 6 fixing screws, that are equipped with washers.
- Lift the unit in the direction indicated in fig. 6.5.C.
- CHECK THAT THE CONTACTS AND THE POSITION-PINS OF THE SWITCH UNIT ARE FREE FROM THE PRE-AMPLIFIER AND TRIGGER UNIT IN ORDER TO PREVENT THAT THE CONTACTS ARE BEND IF THE UNIT IS TAKEN OUT OF THE INSTRUMENT (see fig. 6.6.).
- Take the unit out of the instrument in the direction indicated in fig. 6.5.D).

When remounting, follow the procedure above in reversed sequence and take care that the unit is correctly positioned above the position-pins before inserting the unit.

6.2.7.3. Removal of time base unit

- Remove the screening-plate.
- Unplug 5 coaxial cables.
- Unplug 2 single wire connectors (blue wire of x218, white wire of x217).
- Unplug 4 multipole connectors. One of them is a so called bottom-entry, that is attainable via a square hole in the right-hand chassis plate.
- Remove the 3 fixing screws, one of them (about in the middle of the unit) fixes also the screening-plate.
- Remove the 4 screws in the pushbutton switches that secure the unit to the front panel.
- Lift the unit in the direction indicated in fig. 6.3.A.
- CHECK THAT THE CONTACTS AND THE POSITION-PINS OF THE SWITCH UNIT ARE FREE FROM THE TIME BASE UNIT IN ORDER TO PREVENT THAT THE CONTACTS ARE BEND IF THE UNIT IS TAKEN OUT OF THE INSTRUMENT (see fig. 6.4.).
- Take the unit out of the instrument in the direction indicated in fig. 6.3.B.

When remounting, follow the procedure above in reversed sequence and take care that the unit is correctly positioned above the position-pins before inserting the unit.

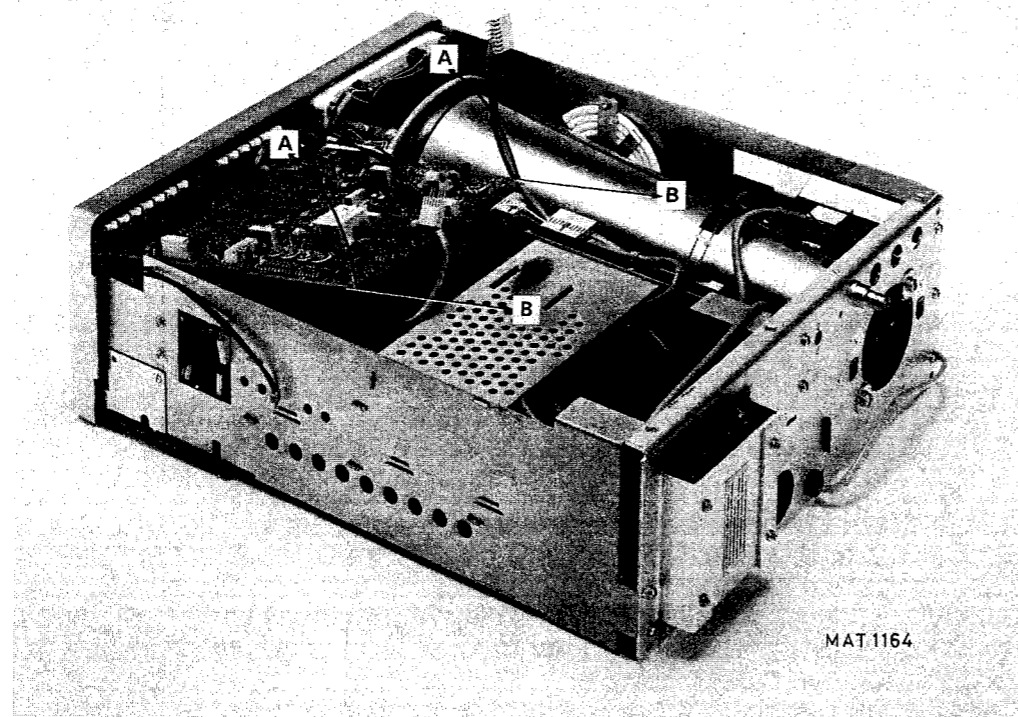

Fig. 6.3. Removal of time-base unit

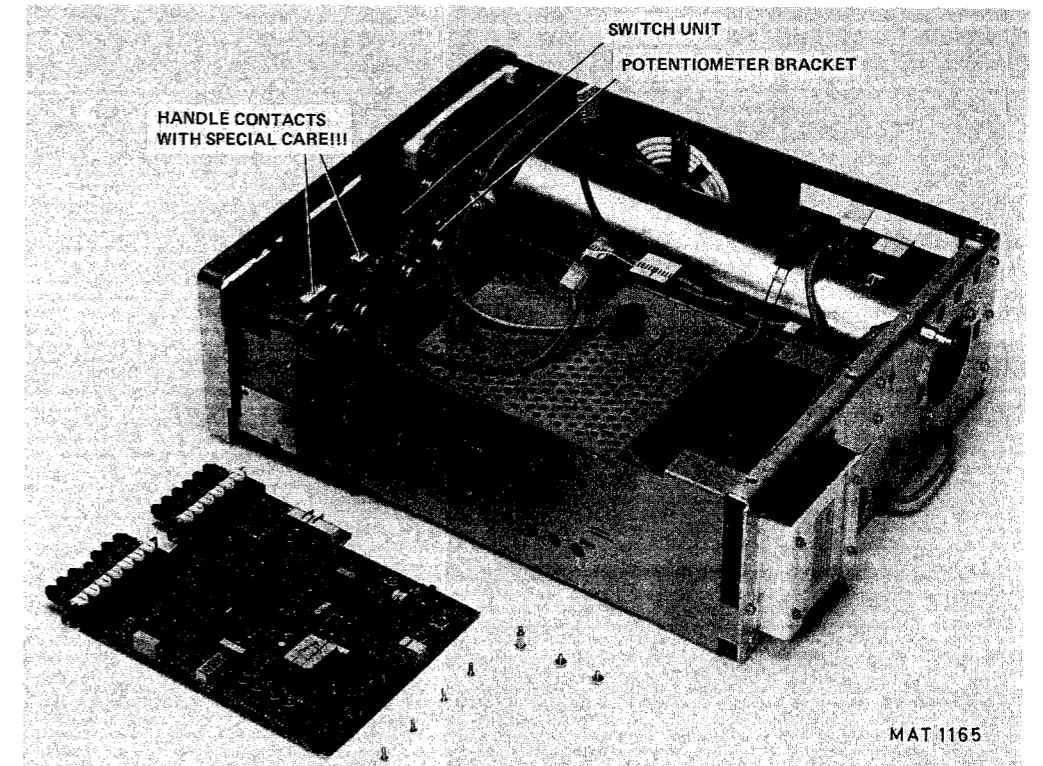

Fig. 6.4. Time-base unit removed

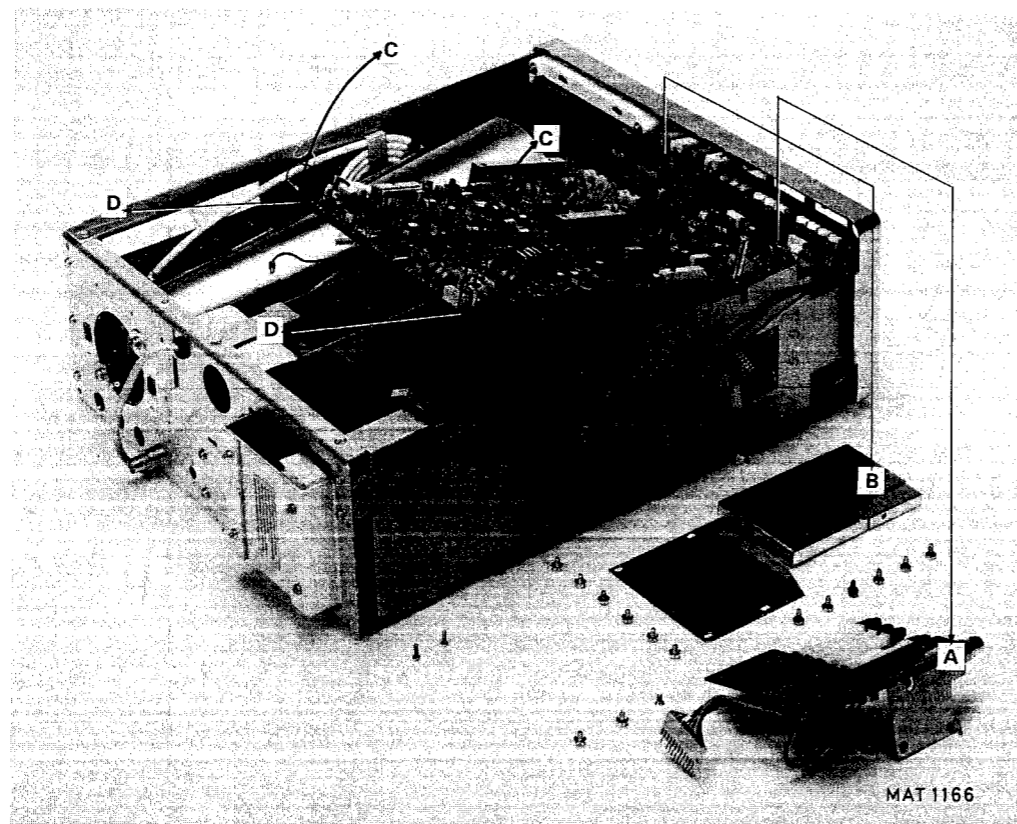

Fig. 6.5. Removal of pre-ampl. and trigger unit

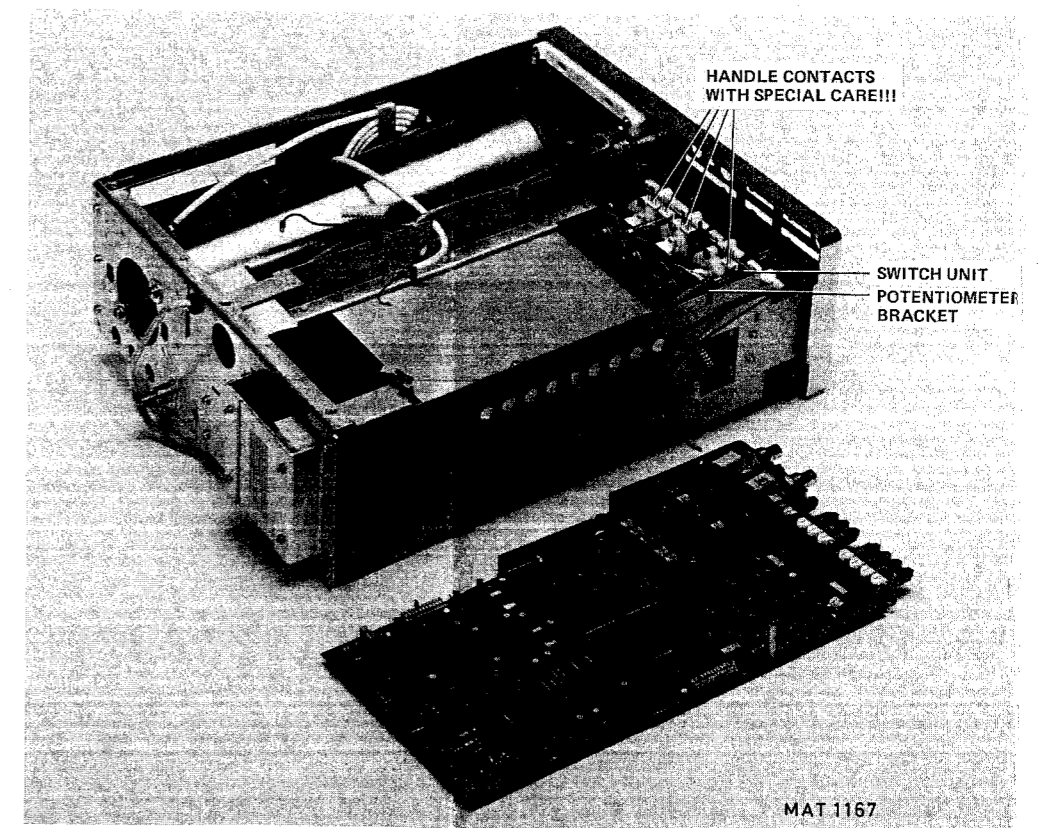

Fig. 6.6. Pre-ampl. and trigger unit removed

6.2.7.4. Removal of switch unit and potentiometer unit

- Remove the time base unit as indicated in chapter 6.2.7.3.
- Remove the trigger source unit as indicated in chapter 6.2.7.1.
- Remove the pre-amplifier and trigger unit as indicated in chapter 6.2.7.2.
- Remove one multipole connector from the final X/Z amplifier unit.
- Remove one multipole connector from the pre-amplifier and trigger unit.
- Remove all the knobs from the front panel.
- Remove 4 star-screws, that secure the switch unit and potentiometer unit to the left and right-hand chassis panel.
- Lift the units upwards out of the instrument.
- The switch board can be separated from the potentiometer unit by means of 4 star screws (one of them is only attainable with a small screwdriver).

IMPORTANT: Repair of parts on the switch unit is not recommended because special tools are required for assembling. As a result the unit is only available as a complete spare part.

6.2.7.5. Removal of power supply EHT unit and mains transformer

- Unplug one four pole connector from the power supply. This connector is attached to a cable that comes from the rear plate.
- Unplug one coaxial lead on the time-base. This lead is from the BNC socket on the rear panel.
- Remove the two star screws that secure the rubber CRT socket to the rear plate (the CRT remains in position by means of its supports at the screen side).
- Remove six screws that secure the top and bottom of the rear plate to the chassis.
- Remove seven screws that secure the rear plate to the chassis. The rear plate can now be taken off.
- Remove the four star screws that secure the mains transformer to the rear plate.
- Remove - if necessary - the star screw that secures the power supply to its compartment. This screw is accessible via a hole in the pre-amplifier and trigger unit.

NOTE: This screw earths the power supply. When remounting the supply, fix this screw as tightly as possible.

- Slide the unit gently out of its compartment and remove - if necessary - the two wires from the EHT multiplier unit.
- To remove the EHT unit, snap it out of the two slots of the power supply compartment. To remove the post-accelerator connection cable first remove the time-base unit according chapter 6.2.7.3.

WARNING: The EHT is unbreakably connected to the EHT multiplier unit. The cable can be disconnected from the CRT. When the EHT-cable is disconnected from the CRT the end of the cable must be discharged immediately by shorting it to the instrument's earth.

6.2.7.6. Replacement of thermal fuse in mains transformer

The double isolation of the instrument is achieved by the isolation properties of the mains transformer. If the mains transformer should become too hot (for instance due to a secondary short-circuit) the isolation layer can be damaged. In order to prevent this, a thermal fuse is incorporated in the mains transformer. If the temperature of the transformer becomes too high, the fuse blows and the mains voltage is interrupted. The blown fuse can be replaced by a new one, if you are sure that the isolation layer of the transformer is not damaged.

For this proceed as follows: Remove the rear plate with the mains transformer. Desolder the two wires of the fuse and slide it out of its compartment within the transformer. Slide the new fuse into the compartment and solder the wires on to the soldering tags of the transformer.

6.2.7.7. Removal of final X/Z amplifier unit

- Unplug 6 multipole connectors.
- Unplug 1 coaxial cable.
- Unplug 2 single-wire connectors from the time-base.
- Remove very carefully the 2 side connections of the CRT.

WARNING: Handle the CRT carefully. Rough handling or scratching can cause the CRT to implode. In particular be very careful with the side connections of the CRT. If these pins are bent the CRT is likely to develop a loss of vacuum.

- Remove 3 fixing screws.
- Lift the unit a little out of its bottom fixing points.
- Unplug 2 wires, that originate from the CRT socket.

CAUTION: These wires carry the –1500Volt life voltages for the CRT; they may neither be touched nor be short-circuited to earth if the instrument is working.

- Unplug 2 wires, that originate from the CAL output socket on the front panel.
- Take the unit out of the instrument.

When remounting follow the procedure above in reversed sequence.

6.2.7.8. Removing the final vertical amplifier unit

- Unplug one multipole connector from the conductor side at the unit.
- Remove very carefully the two side connections of the Y-deflection plates from the CRT. It is also possible to unsolder the two connection wires on the unit.

WARNING: Handle the CRT carefully. Rough handling or scratching can cause the CRT to implode. In particular be very careful with the side connections of the CRT. If these pins are bent the CRT is likely to develop a loss of vacuum.

- Remove the two screws that secure the unit to the left-hand chassis plate.
- Remove the two "star" screws in the heat-sink of the OM518 resistance network that secure the unit to the left-hand chassis plate.
- Unplug the two connections of the delay line from the conductor side of the unit.
- Remove one "star" screw that secures the delay line to the conductor side of the unit.

6.2.7.9. Removal of potentiometer from potentiometer unit

- For R7, R8, R9, R10 and R11: remove the pre-amplifier and trigger unit according to chapter 6.2.7.2.
- For R1, R2, R3, R4, R5 and R6: remove the time base unit according to chapter 6.2.7.3.
- Remove the fixing nut of the potentiometer.
- Unsolder the wires of the potentiometer and take it out of the coupling piece and the potentiometer unit.
- Remove the coupling-disc by pulling it of the potentiometer shaft. Bear in mind that the coupling discs of the potentiometers with a push-pull function are secured with a fixing-washer.

6.2.7.10. Removal of coupling piece

- Remove the potentiometer according to chapter 6.2.7.9.
- Pull the plastic fixing spring out of the coupling piece.
- Remove the coupling piece from the plastic shaft.
- Remove the knob from the plastic shaft; remove the plastic cap from the knob, remove the screw inside the knob and pull the knob off.
- Slide the plastic shaft backwards out of the instrument.

IMPORTANT: When rearranging the coupling piece take care that the flat side at the ends of the plastic shaft and the potentiometer shaft fits correctly in the hole of the coupling discs.

6.2.8. Soldering techniques

Ordinary 60/40 solder and a 35 ... 40 Watt pencil type soldering iron can be used for the majority of the soldering. If a higher wattage-rating soldering iron is used on the etched circuit boards, excessive heat can cause the etched circuit wiring to separate from the base material.

6.3. RECALIBRATION AFTER REPAIR

After any electrical component has been replaced the calibration of that particular circuit should be checked, as well as the calibration of other closely related circuits.

Since the power supply affects all circuits, calibration of the entire instrument should be checked if work has been done on the power supply.

For more detailed information see the interaction table (section 5.6).

6.4. INSTRUMENT REPACKING

If the instrument is to be shipped to a Service Centre for service or repair, attach a tag showing owner (with address) and the name of an individual at your firm who can be contacted. The Service Centre needs the complete instrument serial number and a fault description.

Save and re-use the packing in which your instrument was shipped. If the original packing is unfit for use or not available, repack the instrument in such a way that no danger occurs during transport.

6.5. TROUBLE-SHOOTING

6.5.1. Introduction

The following information is provided to facilitate trouble-shooting. Information contained in other sections of this manual should be used along with the following information to aid in locating the defective component. An understanding of the circuit operation is helpful in locating troubles, particularly where integrated circuits are used. Refer to the Circuit Description section for this information.

6.5.2. Trouble-shooting hints

If a fault appears, the following test sequence can be used to find the defective circuit part:

- Check if the settings of the controls of the oscilloscope are correct. Consult the operating instructions in the operating manual.
- Check the equipment to which the oscilloscope is connected and the interconnection cables.
- Check if the oscilloscope is well-calibrated. If not refer to section 5 (checking and adjusting).
- Visually check the part of the oscilloscope in which the fault is suspected. In this way, it is possible to find faults such as bad soldering connections, bad interconnection plugs and wires, damaged components or transistors and IC's that are not correctly plugged into their sockets.
- Location of the circuit part in which the fault is suspected: the symptom often indicates this part of the circuit. If the power supply is defective the symptom will appear in several circuit parts.

After having carried out the previous steps, individual components in the suspected circuit parts must be examined:

- Transistors and diodes. Check the voltage between base and emitter (0,7 Volt approx. in conductive state) and the voltage between collector and emitter (0,2 Volt approx. in saturation) with a voltmeter or oscilloscope. When removed from the p.c.b. it is possible to test the transistor with an ohmmeter since the base/emitter and base/collector junctions can be regarded as diodes. Like a normal diode, the resistance is very high in one direction and low in the other direction. When measuring take care that the current from the ohmmeter does not damage the component under test.
Replace the suspected component by a new one if you are sure that the circuit is not in such a condition that the new one will be damaged.
- Integrated circuits. In circuit testing can be done with an oscilloscope or voltmeter. A good knowledge of the circuit part under test is essential. Therefore first read the circuit description in section 2.

6.7. ACCESSORY INFORMATION

6.7.1. Adjustments

Matching the probe to your oscilloscope

The measuring probe has been adjusted and checked by the manufacturer. However, to match the probe to your oscilloscope, the following manipulation is necessary.

Connect the measuring pin to the CAL socket of the oscilloscope.

A trimmer C2 (Fig. 6.13.) can be adjusted through a hole in the compensation box to obtain optimum square-wave response. See Fig. 6.7., 6.8. and 6.9.

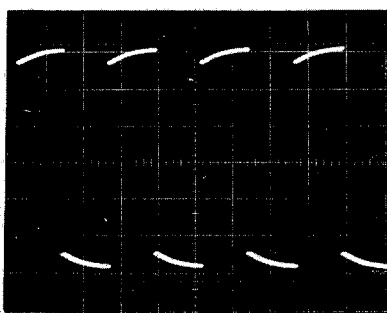

Fig. 6.7. *Over compensation
(adjustment C2)*

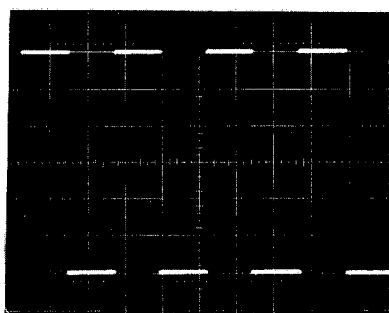

Fig. 6.8. *Correct compensation
(adjustment C2)*

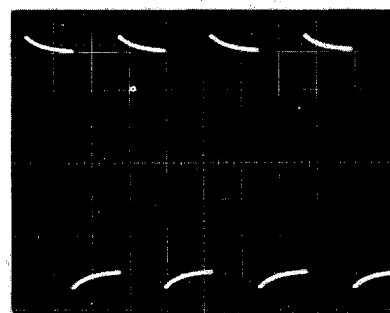

Fig. 6.9. *Under-compensation
(adjustment C2)*

Adjusting the h.f. step response

The h.f. step response correction network has been adjusted by the manufacturer to match the oscilloscope input. For optimum pulse response, for separate delivered probes, the probe can be adjusted to match your particular oscilloscope. Later readjustment is only necessary if the probe is to be used with a different type of oscilloscope, or after replacement of an electrical component.

For the adjustment, proceed as follows:

Connect the probe to a fast pulse generator (rise-time not exceeding 1ns) which is terminated by its characteristic impedance. Dismantle the compensation box. Set the generator to 100kHz. Adjust R2 and R3 alternatively to obtain a display as shown in Fig. 6.10.

It is important that the leading edge is as steep, and the top is as flat, as possible. Incorrect settings of R2 and R3 give rise to pulse distortions as shown in Fig. 6.11. and 6.12.

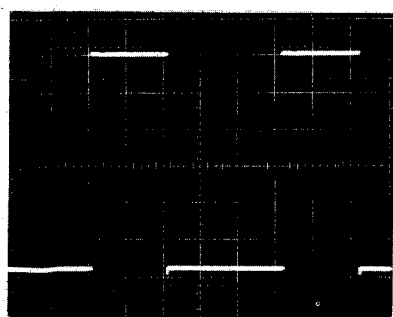

Fig. 6.10. *Preset potentiometers
(correctly adjusted)*

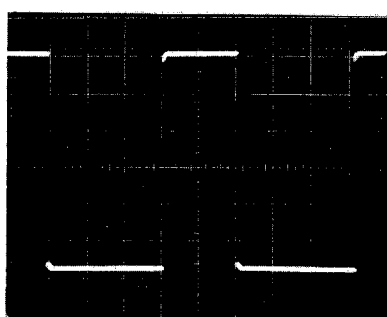

Fig. 6.11. *Rounding due to incorrectly
adjusted potentiometers*

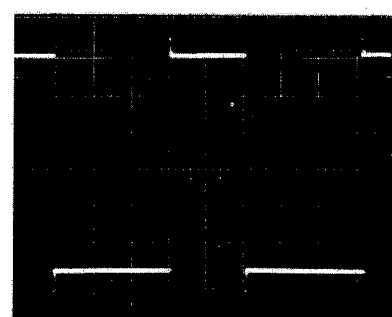

Fig. 6.12. *Overshoot due to incorrectly
adjusted potentiometers*

6.7.2. Dismantling

Dismantling the probe (see Fig. 6.13)

The front part 11 of the probe can be screwed from the rear part 13. Item 11 can then be slid from 12 and 13. The RC combination 12 is soldered to 13. For replacement of 12 refer to the next section.

Dismantling the compensation box (see Fig. 6.13)

Unscrew the ribbed collar of the compensation box to the cable. The case 14 can then be slid sideways off the compensation box. The electrical components of the printed-wiring board are then accessible.

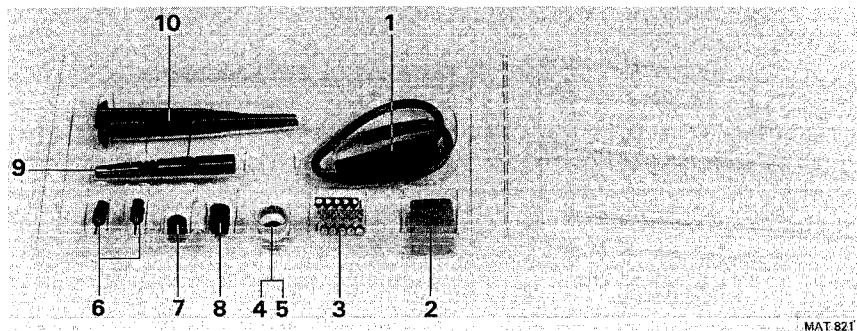
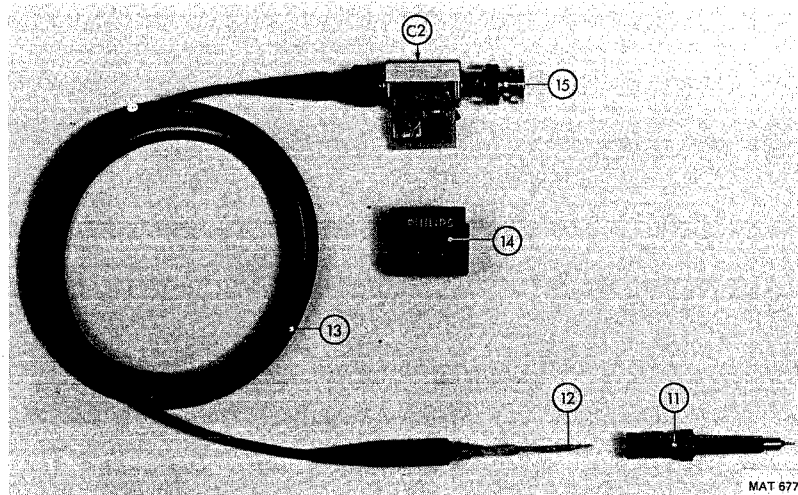

Fig. 6.13. Mechanical parts

6.7.3. Replacing parts

Assembling the probe

A new RC network is slid over the cable nipple, after which the cable core is soldered on to the resistor wire. When the measuring probe is assembled, the RC network must be at dead centre in the probe tip.

Replacing the cable assembly

Dismantle the compensation box.

Unsolder the connection between the inner conductor and the printed-wiring board. Keep the frame of the compensation box steady and loosen the cable nipple with a 5 mm spanner on the hexagonal part. Replace the cable and fit it, working in the reverse order.

6.7.4. Replacing the BNC

Dismantle the compensation box.

Unsolder the connection to the printed-wiring board. Hold the frame of the compensation box firmly and loosen the BNC with a 3/8 inch spanner. Replace the BNC and fit it, working in the reverse order.

Replace the probe tip

The damaged tip can be pulled out by means of a pair of pliers. A new tip must be firmly pushed in.

6.7.4. Parts List

Mechanical parts (see Fig. 6.13 and 6.14.)

Items 1 to 10 are standard accessories supplied with the probe.

Item	Ordering number	Qty	Description
1	5322 321 20223	1	Earth cable
2	5322 256 94136	1	Probe holder
3	5322 255 44026	10	Soldering terminals which may be incorporated in circuits as routine test points
4	5322 532 64223	2	Marking ring red
5	5322 532 64224	2	Marking ring white
5	5322 532 64225	2	Marking ring blue (not shown)
6	5322 268 14017	2	Probe tip
7	5322 462 44319	1	Insulating cap to cover metal part of probe during measurements in densely wired circuits
8	5322 462 44318	2	Cap facilitating measurements on dual-in-line integrated circuits
9	5322 264 24018	1	Wrap pin adaptor
10	5322 264 24019	1	Spring-loaded test clip
11	5322 264 24021	1	Probe shell with check-zero button
12	5322 216 54152	1	RC network
13	5322 320 14063	1	Cable assembly
14	5322 447 64016	1	Cap
15	5322 268 44019	1	BNC connector

Electrical parts

Item	Ordering number	Description
C1	—	Part of RC network (not supplied separately)
C2	5322 125 54003	Trimmer 60 pF, 300 V
R1	—	Part of RC network (not supplied separately)
R2	5322 101 14047	Potmeter 470 Ω , 20 %, 0.5 W
R3	5322 100 10112	Potmeter 1 k Ω , 20 %, 0.5 W

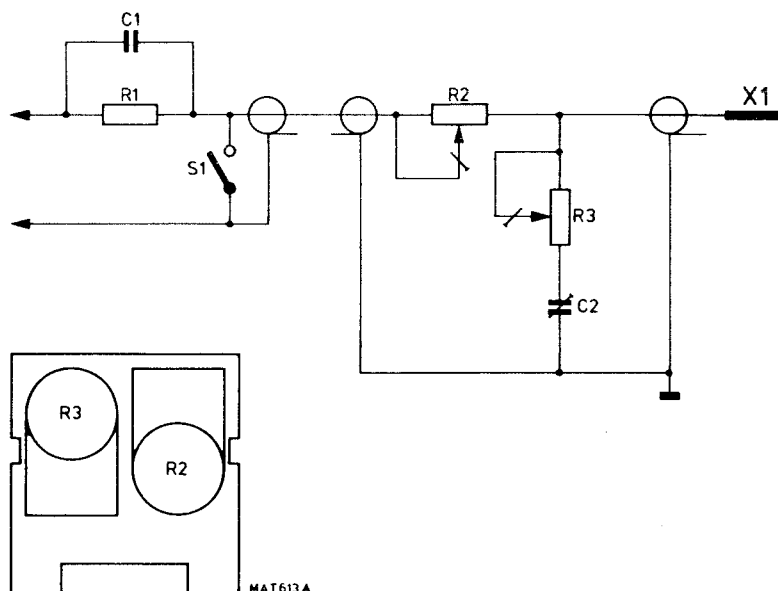

Fig. 6.14. Electrical parts

7. PARTS LIST

Subject to alteration without notice

7.1. PARTS INDICATED IN FIG. 7.1. ... 7.6.

Item	Ord. number	Description
Fig. 7.1.		
1.	5322 414 30004	Ten turn knob (used for "delay time")
2.	5322 414 26415	Pushbutton grey (green (31 pcs./instrument).
3.	5322 414 25851	Pushbutton grey (used for "single").
4.	5322 447 94399	Instrument cover (without handle and feet).
5.	5322 414 74015	Cover, grey with line.
	5322 414 34091	Knob, dia 10mm.
6.	5322 414 74029	Cover, blue with line.
	5322 502 80002	Screw, selftapping
	5322 414 30003	Knob, dia 10mm.
	5322 414 34079	Knob, dia 19mm.
7.	5322 414 34217	Knob (used for "hold off").
	5322 492 64337	Fixing spring for this knob.
8.	5322 267 10004	BNC input socket (used for A, B and EXT).
9.	5322 268 14052	Calibration terminal.
	5322 325 84011	Grommet for calibration terminal.
10.	5322 447 94403	Front cover
11.	5322 462 44297	Rubber foot (of instrument cover).
12.	5322 447 90305	Cast alluminum front frame.
13.	5322 450 74009	Screen bezel.
14.	5322 480 34074	Contrast filter blue.
	5322 480 34046	Contrast filter grey
15.	5322 414 74015	Cover, grey with line.
	5322 414 34134	Knob, dia 10mm.
	5322 492 64337	Clamping spring for knob.
	5322 455 81005	Text plate
16.	5322 455 81004	Text plate PM3267U
	5322 455 81006	Sticker TTL (optional)
	5322 455 81002	Sticker ECL (optional)
Fig. 7.2.		
20.	5322 498 54077	Grip of carrying handle.
	5322 498 54072	Bracket of carrying handle.
	5322 414 64053	Pushbutton knob.
	4822 502 30004	Selftapping screw.
	4822 532 10582	Washer
	5322 520 14267	Bearing bush, plastic.
	5322 530 84075	Spring.
	5322 528 34128	Ratchet.
21.	5322 464 90096	Cast alluminium rear frame.
22.	5322 447 90304	Plastic rear panel.
23.	5322 532 20749	BNC socket Z-Mod.
24.	5322 500 14228	Coin slot screw for rear panel.
	5322 530 70324	Circlip for coin slot screw.
25.	5322 462 44298	Foot (of rear panel).
	4822 502 30096	Selftapping screw of rear panel foot.
26.	5322 325 64083	Line cable cleat, European type.
	5322 325 50101	Line cable cleat, USA type.
27.	4822 321 10084	Line cable, European type.
	4822 321 10092	Line cable, USA type
28.	5322 263 40045	Mains voltage adaptor.

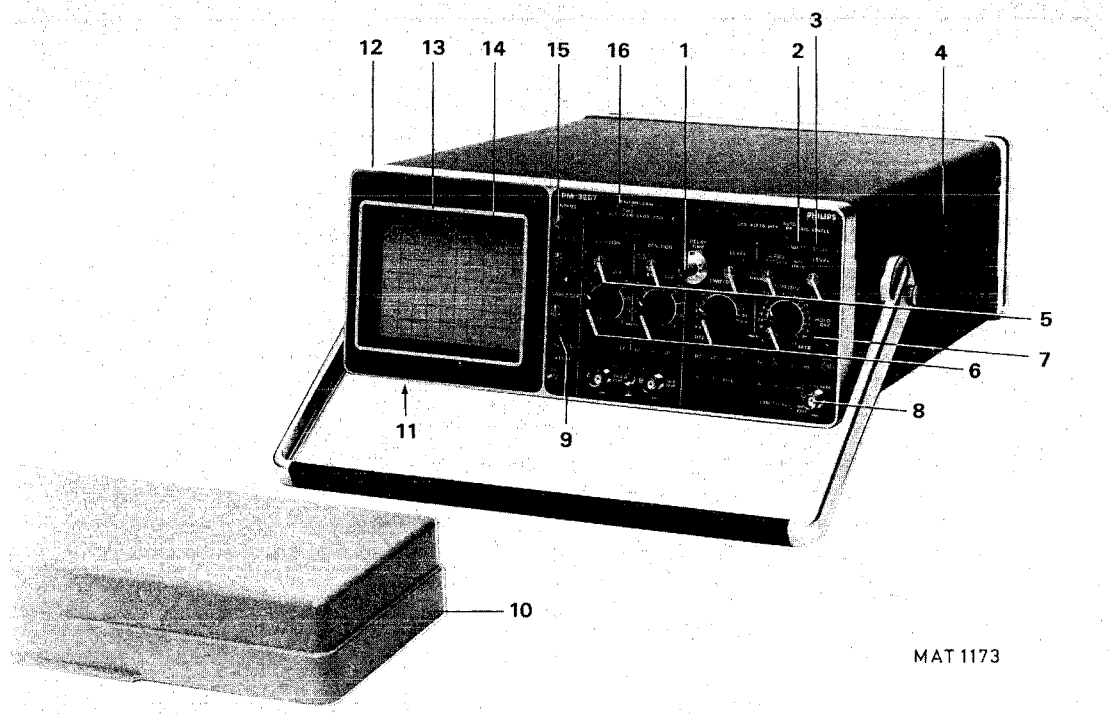

Fig. 7.1. Mechanical parts, front view

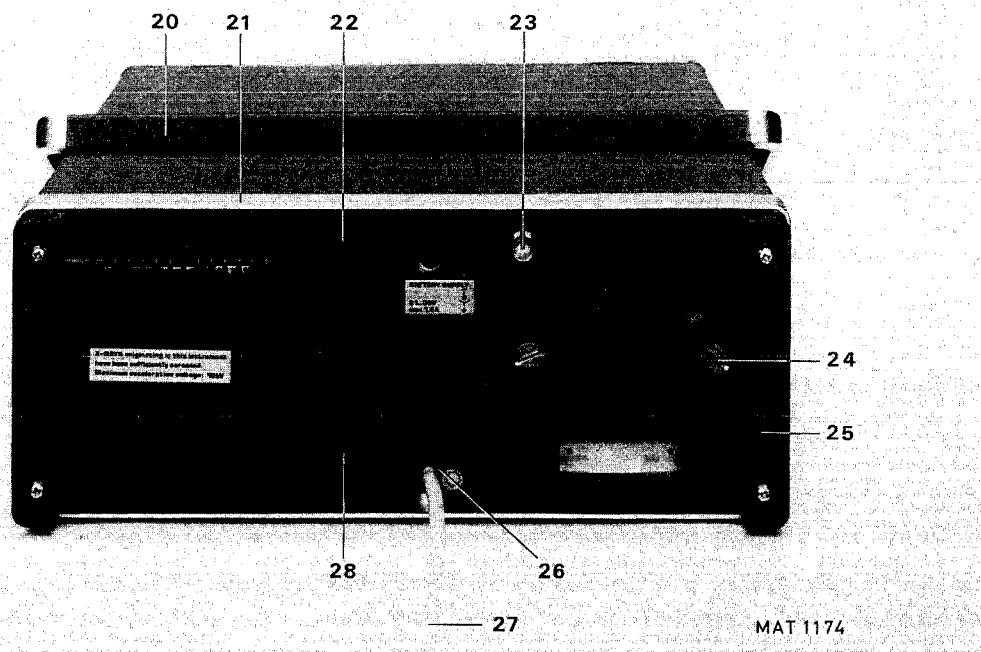

Fig. 7.2. Mechanical parts, rear view

Item	Ord. number	Description
Fig. 7.3.		
30.	5322 218 61017	Trigger selector unit (unit 4).
31.	5322 535 91232	Extension shaft, plastic (for unit 4).
32.	5322 218 61014	Pre-amplifier and trigger unit (unit 3).
33.	5322 532 74014	Rubber socket for CRT-shield.
	5322 492 64767	Bracelet, secures CRT in rubber socket.
34.	5322 218 61016	Final Y-amplifier (unit 9).
35.	5322 320 40093	Delay line cable (unit 8).
36.	5322 466 30124	CRT shield
Fig. 74.		
41.	5322 218 61012	Time base (unit 2)
42.	5322 502 60036	Screw M2,5 x 8 (secures front of unit 2).
43.	5322 380 20136	CRT front support, plastic.
44.	5322 255.24015	Lamp holder (fits in CRT front support).
45.	5322 218 61015	Final X/Z amplifier (unit 5).
46.	4822 265 20051	24VDC input socket.
47.	5322 218 61013	Power supply (unit 6).
48.	5322 218 61003	EHT multiplier unit.
Fig. 7.5.		
50.	5322 535 91585	Plastic shaft (AMPL/DIV, TIME/DIV continuous controls).
	5322 492 62451	Fixing spring, plastic.
	5322 532 60765	Coupling bush, plastic.
	5322 528 20333	Coupling disc, plastic.
51.	5322 502 60036	Screw M2,5 x 8 (secures (front of unit 3).
52.	5322 535 91235	Plastic shaft (hold-off).
	5322 492 62451	Plastic spring.
	5322 532 60765	Coupling bush, plastic.
	5322 528 20333	Coupling disc, plastic.
	4822 530 70043	Spring washer, metal.
Fig. 7.6.		
60.	5322 270 10048	Switch unit, complete (unit 102).
	5322 265 40186	Pin connector, 4 double pins.
	5322 265 40187	Pin connector, 7 double pins.
61.	5322 528 20338	Coupling piece for "delay time".
62.	5322 535 91415	Alluminium shaft (used for position and level controls).
	5322 492 62451	Fixing spring, plastic.
	5322 532 51241	Coupling bush, plastic.
	5322 528 20333	Coupling disc, plastic.
	4822 530 70043	Spring washer, metal.

7.3. Electrical parts

ORDERING CODE

B 1	CQY54/III			5322	130	34875
B 2	CQY54/III			5322	130	34875
B 3	CQY54/III			5322	130	34875
B 4	CQY54/III			5322	130	34875
B 5	CQY54/III			5322	130	34875
C 1102	27PF			5322	125	50164
C 1103	10NF-20+50	100		4822	122	31414
C 1104	10NF-20+50	100		4822	122	31414
C 1105	6,8NF-20+50	100		4822	122	31429
C 1106	10NF-20+50	100		4822	122	31414
C 1107	10NF-20+50	100		4822	122	31414
C 1108	3,9PF 0,25PF	100		5322	122	34107
C 1109	4,7NF 10	100		4822	122	30128
C 1112	27PF			5322	125	50164
C 1113	10PF 2	500		4822	122	31195
C 1114	15PF 2	500		4822	122	31197
C 1201	10NF-20+50	100		4822	122	31414
C 1202	10NF-20+50	100		4822	122	31414
C 1203	10NF-20+50	100		4822	122	31414
C 1204	10NF-20+50	100		4822	122	31414
C 1206	27PF			4822	125	50088
C 1211	27PF			4822	125	50088
C 1214	22PF 2	100		4822	122	31063
C 1216	10NF-20+50	100		4822	122	31414
C 1217	10NF-20+50	100		4822	122	31414
C 1218	100PF 2	100		4822	122	31316
C 1219	2,2PF 0,25PF	100		4822	122	31036
C 1221	100PF 2	100		4822	122	31316
C 1222	2,2PF 0,25PF	100		4822	122	31036
C 1223	10NF-20+50	100		4822	122	31414
C 1224	2,0-18P TRIM			5322	125	50051
C 1226	10NF-20+50	100		4822	122	31414
C 1227	22PF 2	100		4822	122	31063
C 1228	100PF 2	100		4822	122	31316
C 1229	22PF 2	100		4822	122	31063
C 1231	100PF 2	100		4822	122	31316
C 1232	22PF 2	100		4822	122	31063
C 1300	330PF 2	100		4822	122	31353
C 1301	68NF 10% 250V	250V		5322	121	44137
C 1302	68NF 10% 250V	250V		5322	121	44137
C 1303	10NF-20+50	100		4822	122	31414
C 1304	10NF-20+50	100		4822	122	31414
C 1305	330PF 2	100		4822	122	31353
C 1306	1NF 10	500		4822	122	31175
C 1307	1NF 10	500		4822	122	31175
C 1308	8,2PF 0,25PF	100		4822	122	31052
C 1309	8,2PF 0,25PF	100		4822	122	31052
C 1310	390PF 2	100		4822	122	31426
C 1311	10NF-20+50	100		4822	122	31414
C 1314	10NF-20+50	100		4822	122	31414
C 1315	10NF-20+50	100		4822	122	31414
C 1316	10NF-20+50	100		4822	122	31414
C 1317	10NF-20+50	100		4822	122	31414
C 1318	10NF-20+50	100		4822	122	31414
C 1319	68NF 10% 250V	250V		5322	121	44137
C 1320	390PF 2	100		4822	122	31426
C 1321	68NF 10% 250V	250V		5322	121	44137
C 1322	68NF 10% 250V	250V		5322	121	44137
C 1323	22UF 40% 10V	10V		4822	124	20943
C 1326	4,7UF-10+50	63		5322	124	24211
C 1327	4,7UF-10+50	63		5322	124	24211
C 1372	10NF-20+50	100		4822	122	31414
C 1373	220NF 20% 35V	35V		5322	124	14074
C 1401	150UF-10+50	25		4822	124	20703
C 1402	330UF-10+50	10		4822	124	20684
C 1403	33UF 40% 10V	10V		4822	124	20945

ORDERING CODE

C 1406	10UF 50%	16V	5322	124	14066
C 1407	2,7NF 10	100	4822	122	30057
C 1408	13NF 5%	2KV	5322	121	41466
C 1409	13NF 5%	2KV	5322	121	41466
C 1411	330UF-10+50	10	4822	124	20684
C 1412	220UF-10+50	25	5322	124	24139
C 1413	22UF-10+50	63	5322	124	24146
C 1414	100NF 10%	100V	5322	121	40323
C 1415	1,5UF 10%	100V	4822	121	40452
C 1416	47NF 10%	250V	5322	121	44138
C 1417	220NF 10%	100V	4822	121	40232
C 1419	220UF-10+50	25	5322	124	24139
C 1421	10UF-10+50	160	4822	124	21129
C 1422	47UF-10+50	63	5322	124	21182
C 1423	330UF-10+50	10	5322	124	21181
C 1424	330UF-10+50	10	5322	124	21181
C 1426	330UF-10+50	10	5322	124	21181
C 1427	330UF-10+50	10	5322	124	21181
C 1428	68UF-10+50	63	4822	124	20734
C 1430	10NF 10%	630V	5322	121	44201
C 1431	100NF 10%	630V	4822	121	40145
C 1432	10NF-20+50	100	4822	122	31414
C 1433	10UF-10+50	160	4822	124	21129
C 1434	100NF 10%	630V	4822	121	40145
C 1436	22NF 10%	400V	5322	121	40308
C 1437	10UF-10+50	160	4822	124	21129
C 1438	10UF-10+50	160	4822	124	21129
C 1439	100NF 10%	630V	4822	121	40145
C 1441	47UF-10+50	63	5322	124	21182
C 1442	100UF-10+50	10	4822	124	20679
C 1443	6,8UF 20%	25V	5322	124	14081
C 1444	10UF 50%	16V	5322	124	14066
C 1445	4,7NF 10	100	4822	122	30128
C 1446	10NF-20+50	100	4822	122	31414
C 1447	33UF 40%	10V	4822	124	20945
C 1448	2NF 1%	250V	4822	121	50568
C 1449	10NF-20+50	100	4822	122	31414
C1450	82pF				4822 122 31208
C 1451	100NF 10%	100V	5322	121	40323
C 1452	4700UF-10+30	40	4822	124	70326
C 1453	220NF 10%	250V	5322	121	44142
C 1501	68NF 10%	250V	5322	121	44137
C 1502	10NF-20+50	100	4822	122	31414
C 1503	10NF-20+50	100	4822	122	31414
C 1504	22UF 40%	10V	4822	124	20943
C 1506	10NF-20+50	100	4822	122	31414
C 1507	0,82PF 0,25PF	100	4822	122	31214
C 1508	10NF-20+50	100	4822	122	31414
C 1509	4,7NF 10	100	4822	122	30128
C 1510	1NF 10	100	4822	122	30027
C 1511	10NF-20+50	100	4822	122	31414
C 1512	1,5NF 10%	1600V	4822	121	40354
C 1513	1,5NF 10%	1600V	4822	121	40354
C 1514	1NF 10	100	4822	122	30027
C 1516	10UF-10+50	63	4822	124	20728
C 1517	4,7NF 10	100	4822	122	30128
C 1518	10NF-20+50	100	4822	122	31414
C 1519	4,7UF 20%	25V	5322	124	14064
C 1521	10NF-20+50	100	4822	122	31414
C 1522	10NF-20+50	100	4822	122	31414
C 1523	22UF-20+20	25	5322	124	24099
C 1524	10UF-10+50	63	5322	124	24016
C 1526	15UF-20+20	10	5322	124	24008
C 201	33UF-10+50	16	4822	124	20688
C 202	33UF-10+50	16	4822	124	20688
C 204	10NF-20+50	100	4822	122	31414
C 206	10NF-20+50	100	4822	122	31414
C 207	6,8UF 20%	25V	5322	124	14081
C 208	10NF-20+50	100	4822	122	31414

		ORDERING CODE				
C 209	10NF-20+50	100	4822	122	31414	
C 211	10NF-20+50	100	4822	122	31414	
C 212	1NF-20+50	100	4822	122	30027	
C 213	10NF-20+50	100	4822	122	31414	
C 216	10NF-20+50	100	4822	122	31414	
C 218	47NF 10%	250V	5322	121	44138	
C 219			5322	121	54229	
C 221	10NF-20+50	100	4822	122	31414	
C 222	10NF-20+50	100	4822	122	31414	
C 223	10NF-20+50	100	4822	122	31414	
C 224	10NF-20+50	100	4822	122	31414	
C 226			5322	121	54229	
C 227	10NF-20+50	100	4822	122	31414	
C 232	10NF-20+50	100	4822	122	31414	
C 234	47NF 10%	250V	5322	121	44138	
C 236	10NF-20+50	100	4822	122	31414	
C237	6,8 μ F/25V		5322	124	14081	
C 238	10NF-20+50	100	4822	122	31414	
C 239	10NF-20+50	100	4822	122	31414	
C 240	15UF-10+50	40	4822	124	20709	
C 241	1.5UF 10%	100V	5322	121	40227	
C 242	1.5UF 10%	100V	5322	121	40227	
C 243	1.5UF 10%	100V	5322	121	40227	
C 244	10NF-20+50	100	4822	122	31414	
C 245	10NF-20+50	100	4822	122	31414	
C 246	1NF-20+50	100	4822	122	30027	
C 247	10NF-20+50	100	4822	122	31414	
C 248	15UF 10%	16V	4822	124	20977	
C 249	10NF-20+50	100	4822	122	31414	
C 250	220PF	2	100	4822	122	31222
C 251	10NF-20+50	100	4822	122	31414	
C 253	10NF-20+50	100	4822	122	31414	
C 254	10NF-20+50	100	4822	122	31414	
C 255	330NF 10%	100V	4822	121	40257	
C 256	15UF-10+50	40	4822	124	20709	
C 257	15UF-10+50	40	4822	124	20709	
C 258	10NF-20+50	100	4822	122	31414	
C 259	10NF-20+50	100	4822	122	31414	
C 260	10NF-20+50	100	4822	122	31414	
C 261	120PF	2	100	5322	122	34201
C 262	22NF-20+80	40	4822	122	30103	
C 263	470PF	10	100	4822	122	30034
C 264	10NF-20+50	100	4822	122	31414	
C 265	10NF-20+50	100	4822	122	31414	
C 267	10NF-20+50	100	4822	122	31414	
C 268	470NF 10%	100V	5322	121	40175	
C 269	27PF	2	100	4822	122	30045
C 270	10NF-20+50	100	4822	122	31414	
C 271	10NF-20+50	100	4822	122	31414	
C 272	3,9PF 0,25PF	100	5322	122	34107	
C 273	10NF-20+50	100	4822	122	31414	
C 274	4,7PF 0,25PF	100	4822	122	31045	
C 275	10NF-20+50	100	4822	122	31414	
C 276	10NF-20+50	100	4822	122	31414	
C 277	27PF	2	100	4822	122	30045
C 278	4,7PF 0,25PF	100	4822	122	31045	
C 279	3,9PF 0,25PF	100	5322	122	34107	
C 280	10NF-20+50	100	4822	122	31414	
C 282	220NF 10%	100V	4822	121	40232	
C 283	15UF 10%	16V	4822	124	20977	
C 284	10NF-20+50	100	4822	122	31414	
C 285	10NF-20+50	100	4822	122	31414	
C 286	10NF-20+50	100	4822	122	31414	
C 287	10NF-20+50	100	4822	122	31414	
C 288	10NF-20+50	100	4822	122	31414	
C 289	10NF-20+50	100	4822	122	31414	
C 291	10NF-20+50	100	4822	122	31414	

			ORDERING CODE		
C 292	10NF-20+50	100	4822	122	31414
C 501	2,7NF 10	500	4822	122	31174
C 502	100NF 10%	400V	4822	121	40012
C 503	3PF		5322	125	54026
C 504	5,5PF		5322	125	54027
C 505	3,3PF 0,25PF	100	4822	122	31041
C 506	3,3PF 0,25PF	500	4822	122	31188
C 507	300PF 10	300	5322	123	10168
C 508	68PF 2	500	4822	122	31207
C 509	5,5PF		5322	125	54027
C 510	680PF 10	100	4822	122	30053
C 511	3PF		5322	125	54026
C 512	5,5PF		5322	125	54027
C 513	3,3PF 0,25PF	500	4822	122	31188
C 514	30PF 10	300	5322	123	34001
C 521	100PF 2	100	4822	122	31316
C 522	100PF 2	100	4822	122	31316
C 523	100PF 2	100	4822	122	31316
C 524	4,7NF 10	100	4822	122	30128
C 526	4,7NF 10	100	4822	122	30128
C 527	2,7NF 10	100	4822	122	30057
C 528	100PF 2	100	4822	122	31316
C 529	10NF-20+50	100	4822	122	31414
C 531	10NF-20+50	100	4822	122	31414
C 536	3,5PF		5322	125	50048
C 537	12PF 2	100	4822	122	31056
C 538	10NF-20+50	100	4822	122	31414
C 539	10NF-20+50	100	4822	122	31414
C 541	10NF-20+50	100	4822	122	31414
C 542	10NF-20+50	100	4822	122	31414
C 543	39PF 2	100	4822	122	31069
C 544	2,0-18P TRIM		5322	125	50051
C 546	2,0-18P TRIM		5322	125	50051
C 551	100PF 2	100	4822	122	31316
C 552	100PF 2	100	4822	122	31316
C 553	100PF 2	100	4822	122	31316
C554	6,8 μ F/25V		5322	124	14081
C 556	10NF-20+50	100	4822	122	31414
C 561	10UF 50%	16V	5322	124	14066
C 563	33UF 40%	10V	4822	124	20945
C 564	10NF-20+50	100	4822	122	31414
C 566	33UF 40%	10V	4822	124	20945
C 568	33UF 40%	10V	4822	124	20945
C 569	10NF-20+50	100	4822	122	31414
C 572	10UF 50%	16V	5322	124	14066
C 573	10NF-20+50	100	4822	122	31414
C 574	10NF-20+50	100	4822	122	31414
C 576	33UF 40%	10V	4822	124	20945
C 631	10NF-20+50	100	4822	122	31414
C 632	10NF-20+50	100	4822	122	31414
C 633	10NF-20+50	100	4822	122	31414
C 634	10NF-20+50	100	4822	122	31414
C 636	10NF-20+50	100	4822	122	31414
C 637	10NF-20+50	100	4822	122	31414
C 638	10NF-20+50	100	4822	122	31414
C 639	10NF-20+50	100	4822	122	31414
C 641	10NF-20+50	100	4822	122	31414
C 642	10NF-20+50	100	4822	122	31414
C 643	820PF 10	100	4822	122	30135
C 644	10PF 2	100	4822	122	31054
C 646	22PF 2	100	4822	122	31063
C 647	22PF 2	100	4822	122	31063
C 648	2,2PF 0,25PF	100	4822	122	31036
C 649	2,2PF 0,25PF	100	4822	122	31036
C 651	10NF-20+50	100	4822	122	31414

				ORDERING CODE		
C 653	22PF	2	100	4822	122	31063
C 654	100PF	2	100	4822	122	31316
C 656	100PF	2	100	4822	122	31316
C 657	2,7NF	10	500	4822	122	31174
C 701	2,7NF	10	500	4822	122	31174
C 702	100NF 10%		400V	4822	121	40012
C 703	3PF			5322	125	54026
C 704	5,5PF			5322	125	54027
C 705	3,3PF 0,25PF		100	4822	122	31041
C 706	3,3PF 0,25PF		500	4822	122	31188
C 707	300PF	10	300	5322	123	10168
C 708	68PF	2	500	4822	122	31207
C 709	5,5PF			5322	125	54027
C 710	680PF	10	100	4822	122	30053
C 711	3PF			5322	125	54026
C 712	5,5PF			5322	125	54027
C 713	3,3PF 0,25PF		500	4822	122	31188
C 714	30PF	10	300	5322	123	34001
C 716	10NF-20+50		100	4822	122	31414
C 717	10NF-20+50		100	4822	122	31414
C 721	100PF	2	100	4822	122	31316
C 722	100PF	2	100	4822	122	31316
C 723	100PF	2	100	4822	122	31316
C 724	4,7NF	10	100	4822	122	30128
C 726	4,7NF	10	100	4822	122	30128
C 727	2,7NF	10	100	4822	122	30057
C 728	100PF	2	100	4822	122	31316
C 729	10NF-20+50		100	4822	122	31414
C 731	10NF-20+50		100	4822	122	31414
C 736	3,5PF			5322	125	50048
C 737	12PF	2	100	4822	122	31056
C 738	10NF-20+50		100	4822	122	31414
C 739	10NF-20+50		100	4822	122	31414
C 741	10NF-20+50		100	4822	122	31414
C 742	10NF-20+50		100	4822	122	31414
C 743	39PF	2	100	4822	122	31069
C 744	2,0-18P TRIM			5322	125	50051
C 746	2,0-18P TRIM			5322	125	50051
C 751	100PF	2	100	4822	122	31316
C 752	100PF	2	100	4822	122	31316
C 753	100PF	2	100	4822	122	31316
C754	6,8μF/25V			5322	124	14081
C 756	10NF-20+50		100	4822	122	31414
C 760	220UF-10+50		10	4822	124	20681
C 761	33UF 40%		10V	4822	124	20945
C 762	10NF-20+50		100	4822	122	31414
C 763	10NF-20+50		100	4822	122	31414
C 764	33UF-10+50		16	4822	124	20688
C 766	10NF-20+50		100	4822	122	31414
C 767	10NF-20+50		100	4822	122	31414
C 768	10NF-20+50		100	4822	122	31414
C 771	100NF 10%		100V	5322	121	40323
C 772	10NF-20+50		100	4822	122	31414
C 773	10NF-20+50		100	4822	122	31414
C 780	150UF-10+50		16	4822	124	20586
C 781	6,8UF 20%		25V	5322	124	14081
C 782	10NF-20+50		100	4822	122	31414
C 783	10NF-20+50		100	4822	122	31414
C 784	10NF-20+50		100	4822	122	31414
C 786	10NF-20+50		100	4822	122	31414

ORDERING CODE

C 787	10NF-20+50	100	4822	122	31414
C 788	10NF-20+50	100	4822	122	31414
C 800	220UF-10+50	10	4822	124	20681
C 801	33UF 40%	10V	4822	124	20945
C 802	10NF-20+50	100	4822	122	31414
C 803	33UF 40%	10V	4822	124	20945
C 804	10NF-20+50	100	4822	122	31414
C 806	10NF-20+50	100	4822	122	31414
C 807	10NF-20+50	100	4822	122	31414
C 808	10NF-20+50	100	4822	122	31414
C 831	10NF-20+50	100	4822	122	31414
C 851	10PF 2	100	4822	122	31054
C 852	10NF-20+50	100	4822	122	31414
C 853	10NF-20+50	100	4822	122	31414
C 854	10NF-20+50	100	4822	122	31414
C 856	33UF 40%	10V	4822	124	20945
C 857	10NF-20+50	100	4822	122	31414
C 858	680PF 10	100	4822	122	30053
C 861	2,7PF 0,25PF	100	4822	122	31038
C860	33μF/16V				4822 124 20688
C 862	2,7PF 0,25PF	100	4822	122	31038
C 863	33PF 2	100	4822	122	31067
C 864	10PF 2	100	4822	122	31054
C 866	10NF-20+50	100	4822	122	31414
C 867	33UF 40%	10V	4822	124	20945
C 868	220NF 10%	100V	4822	121	40232
C 869	12PF 2	100	4822	122	31056
C 870	33PF 2	100	4822	122	31067
C 872	10NF-20+50	100	4822	122	31414
C 873	10NF-20+50	100	4822	122	31414
C 874	3,3PF 0,25PF	100	4822	122	31041
C 878	3,3PF 0,25PF	100	4822	122	31041
C 879	33PF 2	100	4822	122	31067
C 881	22PF 2	100	4822	122	31063
C 882	1PF 0,25PF	100	4822	122	30104
C 884	12PF 2	100	4822	122	31056
C 885	10NF-20+50	100	4822	122	31414
C 888	6,8UF 20%	25V	5322	124	14081
C 889	10NF-20+50	100	4822	122	31414
C 890	10NF-20+50	100	4822	122	31414
C 893	220NF 10%	100V	4822	121	40232
C 896	4,7PF 0,25PF	100	4822	122	31045
C 897	4,7PF 0,25PF	100	4822	122	31045
C 898	10NF-20+50	100	4822	122	31414
C 899	10NF-20+50	100	4822	122	31414
C 900	10PF 2	100	4822	122	31054
C 902	10NF-20+50	100	4822	122	31414
C 903	10NF-20+50	100	4822	122	31414
C 904	22NF 10%	400V	5322	121	44232
C 905	100PF 2	100	4822	122	31316
C 906	10NF-20+50	100	4822	122	31414
C 907	4,7PF 0,25PF	100	4822	122	31045
C 908	10NF-20+50	100	4822	122	31414
C 909	10NF-20+50	100	4822	122	31414
C 910	22PF 2	100	4822	122	31063
C 911	10NF-20+50	100	4822	122	31414
C 913	10NF-20+50	100	4822	122	31414
C 914	10NF-20+50	100	4822	122	31414
C 915	33UF-10+50	16	4822	124	20688
C 916	3,9NF 10	100	4822	122	30098
C 917	4,7NF 10	100	4822	122	30128

				ORDERING CODE		
C 918	4,7NF	10	100	4822	122	30128
C 919	10NF-20+50		100	4822	122	31414
C 920	10NF-20+50		100	4822	122	31414
C 921	1,8PF 0,25PF		100	4822	122	31034
C 922	10NF-20+50		100	4822	122	31414
C 923	1,8PF 0,25PF		100	4822	122	31034
C 924	1PF 0,25PF		100	4822	122	30104
C 925	100PF	2	100	4822	122	31316
C 926	1PF 0,25PF		100	4822	122	30104
C 927	1,8PF 0,25PF		100	4822	122	31034
C 928	1,8PF 0,25PF		100	4822	122	31034
C 929	680PF	10	100	4822	122	30053
C 930	33PF	2	100	4822	122	31067
C 931	220NF 10%		100V	4822	121	40232
C 932	10NF-20+50		100	4822	122	31414
C 933	100PF	2	100	4822	122	31316
C 934	1PF 0,25PF		100	4822	122	30104
C 935	33PF	2	100	4822	122	31067
C 936	1PF 0,25PF		100	4822	122	30104
C 937	33PF	2	100	4822	122	31067
C 938	15PF	2	100	4822	122	31058
C 939	10NF-20+50		100	4822	122	31414
C 940	68PF	2	100	4822	122	31349
C 942	10NF-20+50		100	4822	122	31414
C 944	10NF-20+50		100	4822	122	31414
C 945	10NF-20+50		100	4822	122	31414
D 1201	OM504			5322	216	54192
D 1202	HIC-P5185	PH		5322	255	44246
D 1203				5322	116	90118
D 1204				5322	116	90118
D 1401	UA741CN	SC		4822	209	80617
D 1402	TDA1060	PH		5322	209	85662
D 1403	R			5322	218	61003
D 1501	UA741CN	SC		4822	209	80617
D 201	UA741CN	SC		4822	209	80617
D 202	TCA240	PH		4822	209	80629
D 203	SN74S132N-00	T		5322	209	85267
D 204	N74LS02N	SC		5322	209	85312
D 206	N74LS00N	SC		5322	209	84823
D 207	74F74PC	FA		5322	209	81474
D 208	N74LS02N	SC		5322	209	85312
D 209	N74S02N	SC		5322	209	85407
D 211	N74LS10N	SC		5322	209	84996
D 212	74F74PC	FA		5322	209	81474
D 213	SN74LS122N-00	T		5322	209	85563
D 214	SN74S132N-00	T		5322	209	85267
D 216	LM308AN	SC		5322	209	86056
D 217	N74S32N	SC		5322	209	85679
D 218	N74S10N	SC		5322	209	84954
D 501	UA714HC	FA		5322	209	86169
D 502	UA714HC	FA		5322	209	86169
D 503	SD5000N	SC		5322	209	85748
D 631	PLIFIER			5322	209	80991
D 632	N74LS08N	SC		5322	209	84995
D 633	N74LS132N	SC		5322	209	85201
D 634	N74LS112N	SC		5322	209	84237
D 636	UA741CN	SC		4822	209	80617
D 637	LM79L05ACZ	NS		5322	209	86434
D 701	UA714HC	FA		5322	209	86169
D 702	UA714HC	FA		5322	209	86169

				ORDERING CODE		
D 703	SD5000N	SC		5322	209	85748
D 831	PLIFIER			5322	209	80991
D 851	HEF4052BP	PH		5322	209	14233
D 852	TL082CP	T		5322	209	86064
D 853	ARRAY OQ 0127			5322	209	80992
D 854	ARRAY OQ 0127			5322	209	80992
F 1401	T2A			4822	253	30025
F 1402	500 MAT			4822	253	30017
K 1371				5322	280	20099
K 501				5322	280	20101
K 502				5322	280	20099
K 503				5322	280	20101
K 504				5322	280	20099
K 506				5322	280	20101
K 507				5322	280	20099
K 701				5322	280	20101
K 702				5322	280	20099
K 703				5322	280	20101
K 704				5322	280	20099
K 706				5322	280	20101
K 707				5322	280	20099
K 851				5322	280	20099
L 1				5322	134	44177
L 1401	COIL			5322	156	44014
L 1402	COIL			5322	281	64154
L 1403	COIL			5322	156	44014
L 1404	COIL			5322	156	44014
L 2				5322	134	44177
L 4	SPOEL			5322	157	51614
L 501	ASSY COIL			5322	158	30199
L 701	ASSY COIL			5322	158	30199
L 801	COIL			5322	156	44014
L 802	COIL			5322	156	44014
L 803	COIL			5322	156	44014
R 1	10K	20	0.1W	5322	101	40097
R 10	10K	20	0.1W	5322	101	40096
R 1000	17,8	1	MR25	5322	116	50418
R 1001	287	1	MR25	5322	116	54506
R 1002	100	1	MR25	5322	116	55549
R 1003	5,11	1	MR25	5322	116	54192
R 1004	48,7	1	MR25	5322	116	50511
R 1005	100	1	MR25	5322	116	55549
R1006			316K/MR25			5322 116 54154
R 1007	100K	1	MR25	4822	116	51268
R 1008	1,15K	1	MR25	5322	116	50415
R 101	191K	0,5	MR25	5322	116	55363
R 1011	5,9K	1	MR25	5322	116	50583
R 1013	100K	1	MR25	4822	116	51268
R 1014	10K	1	MR25	4822	116	51253
R 1016	3,01K	1	MR25	4822	116	51246
R 1017	5,11K	1	MR25	5322	116	54595
R 1019	274	1	MR25	5322	116	54504
R 102	113	0,5	MR25	5322	116	54019
R 1021	274	1	MR25	5322	116	54504
R 1022	1K	1	MR25	4822	116	51235
R 1023	487	1	MR25	5322	116	55451
R 1024	750	1	MR25	4822	116	51234
R 1026	30,1	1	MR25	5322	116	50904
R 1027	1K	1	MR25	4822	116	51235
R 1028	487	1	MR25	5322	116	55451

						ORDERING CODE		
R 1029	750	1	MR25	4822	116	51234		
R 103	1,05K	1	MR25	5322	116	54552		
R 1031	30,1	1	MR25	5322	116	50904		
R 1032	1K	1	MR25	4822	116	51235		
R 1033	487	1	MR25	5322	116	55451		
R 1034	750	1	MR25	4822	116	51234		
R 1036	30,1	1	MR25	5322	116	50904		
R 1037	1K	1	MR25	4822	116	51235		
R 1038	487	1	MR25	5322	116	55451		
R 1039	750	1	MR25	4822	116	51234		
R 104	2,94K	0,5	MR25	5322	116	51396		
R 1041	30,1	1	MR25	5322	116	50904		
R 1042	1K	1	MR25	4822	116	51235		
R 1043	487	1	MR25	5322	116	55451		
R 1044	750	1	MR25	4822	116	51234		
R 1045	274	1	MR25	5322	116	54504		
R 1046	30,1	1	MR25	5322	116	50904		
R 1047	1K	1	MR25	4822	116	51235		
R 1048	487	1	MR25	5322	116	55451		
R 1049	750	1	MR25	4822	116	51234		
R 1051	30,1	1	MR25	5322	116	50904		
R 1054	1K	20	0.75W	5322	100	10143		
R 1056	48,7	1	MR25	5322	116	50511		
R 1057	9,53K	1	MR25	5322	116	54617		
R 1058	5,11K	1	MR25	5322	116	54595		
R 1059	5,11K	1	MR25	5322	116	54595		
R 106	8,66K	1	MR25	5322	116	54613		
R 1060	100	1	MR25	5322	116	55549		
R 1061	1K	1	MR25	4822	116	51235		
R 1062	5,11	1	MR25	5322	116	54192		
R 1063	3,01K	1	MR25	4822	116	51246		
R 1064	4,02K	1	MR25	5322	116	55448		
R 1065	100	1	MR25	5322	116	55549		
R 1066	866	1	MR25	5322	116	54543		
R 1067	51,1K	1	MR25	5322	116	50672		
R 1068	10K	1	MR25	4822	116	51253		
R 1069	196K	1	MR25	5322	116	55364		
R 107	1,05K	1	MR25	5322	116	54552		
R 1071	866K	1	MR25	5322	116	51395		
R 1072	402K	1	MR25	5322	116	55283		
R 1073	100	1	MR25	5322	116	55549		
R 1076	1K	1	MR25	4822	116	51235		
R 1077	511	1	MR25	4822	116	51282		
R 1078	38,3	1	MR25	5322	116	50954		
R 1079	38,3	1	MR25	5322	116	50954		
R 108	95,3K	1	MR25	5322	116	50567		
R 1080	100	1	MR25	5322	116	55549		
R 1081	511	1	MR25	4822	116	51282		
R 1082	100	1	MR25	5322	116	55549		
R 1083	100	1	MR25	5322	116	55549		
R 1084	48,7	1	MR25	5322	116	50511		
R 1085	51,1K	1	MR25	5322	116	50672		
R 1086	30,1	1	MR25	5322	116	50904		
R 1087	402	1	MR25	5322	116	54519		
R 1088	649	1	MR25	5322	116	54532		
R 1089	2,49K	1	MR25	5322	116	50581		
R 109	113	0,5	MR25	5322	116	54019		
R 1090	100	1	MR16	5322	116	55392		
R 1091	196	1	MR25	5322	116	55273		
R 1092	402	1	MR25	5322	116	54519		

ORDERING CODE

R 1093	30,1	1	MR25	5322	116	50904
R 1094	1,05K	1	MR25	5322	116	54552
R 1095	100	1	MR16	5322	116	55392
R 1096	649	1	MR25	5322	116	54532
R 1097	1,87K	1	MR25	5322	116	50728
R 1098	100	1	MR16	5322	116	55392
R 1099	100	1	MR16	5322	116	55392
R 11	10K	20	0.1W	5322	101	40096
R 1101	178	1	MR25	5322	116	54492
R 1102	100	1	MR25	5322	116	55549
R 1103	220	20	0,5W	5322	101	14009
R 1104	220	20	0,5W	5322	101	14009
R 1105	10	1	MR25	5322	116	50452
R 1106	3,01K	1	MR25	4822	116	51246
R 1107	4,02K	1	MR25	5322	116	55448
R 1108	402	1	MR25	5322	116	54519
R 1109	178	1	MR25	5322	116	54492
R 111	2,94K	0,5	MR25	5322	116	51396
R 1110	100	1	MR25	5322	116	55549
R 1111	22,6K	1	MR25	5322	116	50481
R 1113	48,7	1	MR25	5322	116	50511
R 1114	48,7	1	MR25	5322	116	50511
R 1115	4,22K	1	MR25	5322	116	50729
R 1116	48,7	1	MR25	5322	116	50511
R 1117	5,11K	1	MR25	5322	116	54595
R 1118	24,9	1	MR25	5322	116	50903
R 1119	24,9	1	MR25	5322	116	50903
R 112	37,4K	0,5	MR25	5322	116	51397
R 1121	5,11K	1	MR25	5322	116	54595
R 1122	5,6M	5	VR25	4822	110	72207
R 1123	5,6M	5	VR25	4822	110	72207
R 1124	100	1	MR25	5322	116	55549
R 1126	750K	0,5	MR30	5322	116	51706
R 1127	249K	1	MR25	5322	116	54734
R 1129	162	1	MR25	5322	116	50417
R 113	953K	1	MR25	5322	116	51368
R 1131	205	1	MR25	5322	116	55365
R 114	18,2K	0,1	MR24E	5322	116	51403
R 116	383K	1	MR25	5322	116	55335
R 117	191K	0,5	MR25	5322	116	55363
R 118	95,3K	1	MR25	5322	116	50567
R 119	37,4K	0,5	MR25	5322	116	51397
R 12	4,7K	20	0.1W	5322	101	20691
R 1201	1	1	MR25	4822	116	51179
R 1202	2,15	1	MR25	5322	116	55536
R 1203	2,15	1	MR25	5322	116	55536
R 1206	147	1	MR25	5322	116	50766
R 1207	11K	1	MR25	5322	116	54623
R 1208	2,61K	1	MR25	5322	116	50671
R 1209	147	1	MR25	5322	116	50766
R 121	18,2K	0,1	MR24E	5322	116	51403
R 1211	1,33K	1	MR25	5322	116	55422
R 1212	215	1	MR25	5322	116	55274
R 1213	1K	20	0.75W	5322	100	10143
R 1214	121	1	MR25	5322	116	54426
R 1216	121	1	MR25	5322	116	54426
R 1217	220	20	0.75W	5322	100	10133
R 1218	100	1	MR25	5322	116	55549
R 1219	383	1	MR25	5322	116	55368
R 122	8,66K	1	MR25	5322	116	54613

				ORDERING CODE		
R 1221	1,47K	1	MR25	5322	116	50635
R 1227	10K	1	MR25	4822	116	51253
R 1228	100K	5	0.5W	5322	116	30236
R 1229	178K	1	MR25	5322	116	54721
R1232		21K5/MR25				5322 116 50451
R1233		38K3/MR25				5322 116 50483
R 1234	316	1	MR25	5322	116	54511
R 1235	51,1	1	MR25	5322	116	54442
R 1236	511	1	MR25	4822	116	51282
R 1237	100	1	MR25	5322	116	55549
R 1238	1K	1	MR25	4822	116	51235
R 1239	422	1	MR25	5322	116	50459
R 1240	51,1	1	MR25	5322	116	54442
R 1241	316	1	MR25	5322	116	54511
R 1242	511	1	MR25	4822	116	51282
R 1243	100	1	MR25	5322	116	55549
R 1244	1K	1	MR25	4822	116	51235
R 1246	422	1	MR25	5322	116	50459
R 1247	237	1	MR25	5322	116	50679
R 1248	16,2	1	MR25	5322	116	54431
R 1249	14,7	1	MR25	5322	116	50412
R 1251	215	1	MR25	5322	116	55274
R 1252	215	1	MR25	5322	116	55274
R 1253	1,47K	1	MR25	5322	116	50635
R 1254	316	1	MR25	5322	116	54511
R 1256	1K	20	0.75W	5322	100	10143
R 1257	14,7	1	MR25	5322	116	50412
R 1258	3,83K	1	MR25	5322	116	54589
R 1259	4,22K	1	MR25	5322	116	50729
R 1261	162	1	MR25	5322	116	50417
R 1262	237	1	MR25	5322	116	50679
R 1263	100	1	MR25	5322	116	55549
R 1264	178	1	MR25	5322	116	54492
R 1266	237	1	MR25	5322	116	50679
R 1267	178	1	MR25	5322	116	54492
R 1268	100	1	MR25	5322	116	55549
R 1269	100	1	MR30	5322	116	54852
R 13	2,2M	20	0.1W	5322	101	20692
R 1300	19,6K	1	MR25	5322	116	54641
R 1301	100	1	MR25	5322	116	55549
R 1302	4,02K	1	MR25	5322	116	55448
R 1303	1	1	MR25	4822	116	51179
R 1304	100	1	MR25	5322	116	55549
R 1305	5,11	1	MR25	5322	116	54192
R 1306	3,01K	1	MR25	4822	116	51246
R1307		649E/MR25				5322 116 54532
R1308		1K78/MR25				5322 116 50515
R 1309	2,61K	1	MR25	5322	116	50671
R 1310	19,6K	1	MR25	5322	116	54641
R 1311	4,22K	1	MR25	5322	116	50729
R 1312	140K	1	MR25	5322	116	54259
R 1313	15,4K	1	MR25	5322	116	55459
R 1314	3,01K	1	MR25	4822	116	51246
R 1315	649	1	MR25	5322	116	54532
R 1316	3,01K	1	MR25	4822	116	51246
R 1317	3,32K	1	MR25	5322	116	54005
R 1318	301	1	MR25	5322	116	55366
R 1319	301	1	MR25	5322	116	55366
R 1320	649	1	MR25	5322	116	54532
R1321		7K5/MR25				5322 116 54608

ORDERING CODE

R 1322	487	1	MR25	5322	116	55451
R 1323	46,4K	1	MR25	5322	116	50557
R 1324	46,4K	1	MR25	5322	116	50557
R 1325	147	1	MR25	5322	116	50766
R 1326	487	1	MR25	5322	116	55451
R1327		7K5/MR25				5322 116 54608
R 1328	86,6K	1	MR25	5322	116	54692
R 1329	71,5K	1	MR25	5322	116	54685
R 1330	147	1	MR25	5322	116	50766
R1331		133K/MR25				5322 116 54708
R 1332	16,2K	1	MR25	5322	116	55361
R 1333	4,64K	1	MR25	5322	116	50484
R 1334	953	1	MR25	5322	116	54547
R 1336	402K	1	MR25	5322	116	55283
R 1337	1	1	MR25	4822	116	51179
R 1338	953	1	MR25	5322	116	54547
R 1339	402K	1	MR25	5322	116	55283
R 1347	1	1	MR25	4822	116	51179
R1360		31K6/MR25				5322 116 54657
R 1361	18,7K	1	MR25	5322	116	55362
R 1362	511K	1	MR25	5322	116	55258
R 1363	13,3K	1	MR25	5322	116	55276
R 1370	10	1	MR25	5322	116	50452
R 1371	26,1K	1	MR25	5322	116	54651
R 1372	9,53K	1	MR25	5322	116	54617
R 1373	649	1	MR25	5322	116	54532
R 1374	1,54K	1	MR25	5322	116	50586
R 1376	3,01K	1	MR25	4822	116	51246
R 1377	100	1	MR25	5322	116	55549
R 1378	154	1	MR25	5322	116	50506
R 1381	100	20	0,5W	5322	101	14011
R 1383	1,54K	1	MR25	5322	116	50586
R 1384	10K	20	0,5W	5322	100	10113
R 1388	10	1	MR25	5322	116	50452
R 1389	4,22K	1	MR25	5322	116	50729
R 1392	953	1	MR25	5322	116	54547
R 14	22K	20	0.1W	4822	101	20417
R 1401	40,2K	1	MR25	5322	116	54665
R 1402	1,27	1	MR25	5322	116	51393
R 1403	1,27	1	MR25	5322	116	51393
R 1404	1,27	1	MR25	5322	116	51393
R 1406	24,9K	1	MR25	5322	116	54648
R 1407	2,2M	5	VR37	4822	110	42196
R 1408	10K	1	MR25	4822	116	51253
R 1409	15,4K	1	MR25	5322	116	55459
R 1411	1,2M	5	VR37	4822	110	42189
R 1412	5,6M	5	VR37	4822	110	42207
R 1413	10M	1	VR37	4822	110	42214
R 1414	100K	1	MR25	4822	116	51268
R 1416	100K	1	MR25	4822	116	51268
R 1417	1K	1	MR25	4822	116	51235
R 1418	21,5	1	MR25	5322	116	50677
R 1419	90,9K	1	MR25	5322	116	54694
R 1420	4,02K	1	MR25	5322	116	55448
R 1421	10K	1	MR25	4822	116	51253
R 1422	100K	1	MR25	4822	116	51268
R 1423	100K	1	MR25	4822	116	51268
R 1424	196	1	MR25	5322	116	55273
R 1426	6,81K	1	MR25	4822	116	51252
R 1428	21,5K	1	MR25	5322	116	50451

ORDERING CODE

R 1429	3,16K	1	MR25	5322	116	50579
R 1430	100	1	MR25	5322	116	55549
R 1431	51,1	1	MR25	5322	116	54442
R 1432	51,1	1	MR25	5322	116	54442
R 1433	13K	1	MR25	5322	116	50522
R 1434	100K	1	MR25	4822	116	51268
R 1435	100	1	MR25	5322	116	55549
R 1436	78,7K	1	MR25	5322	116	50533
R 1437	13,3K	1	MR25	5322	116	55276
R 1438	750	1	MR25	4822	116	51234
R 1439	3,83K	1	MR25	5322	116	54589
R 1440	11	1	MR25	5322	116	54059
R 1441	19,6	1	MR25	5322	116	50473
R 1442	6,19K	1	MR25	5322	116	55426
R 1443	261	1	MR25	5322	116	54502
R 1444	1K	1	MR25	4822	116	51235
R 1446	2,49K	1	MR25	5322	116	50581
R 1447	10K	1	MR25	4822	116	51253
R 1448	5,9K	1	MR25	5322	116	50583
R 1449	100K	1	MR25	4822	116	51268
R 1451	5,11K	1	MR25	5322	116	54595
R 1452	4,64K	1	MR25	5322	116	50484
R 1453	30,1K	1	MR25	5322	116	54655
R 1456	14,7K	1	MR25	5322	116	54632
R 1457	1,54K	1	MR25	5322	116	50586
R 1458	1,27K	1	MR25	5322	116	50555
R 1459	100K	1	MR25	4822	116	51268
R 1460	5,11	1	MR25	5322	116	54192
R 1461	24,9K	1	MR25	5322	116	54648
R 1462	4,64K	1	MR25	5322	116	50484
R 1463	226	1	MR25	5322	116	54497
R 1464	8,25K	1	MR25	5322	116	54558
R 1466	23,7K	1	MR25	5322	116	54646
R 1467	750	1	MR25	4822	116	51234
R 1468	15,4K	1	MR25	5322	116	55459
R 1469	20,5K	1	MR25	5322	116	54643
R 1470	100	1	MR25	5322	116	55549
R 1471	100K	20	0.5W	5322	101	10312
R 1472	1M	20	0.5W	5322	101	10314
R 1473	220K	20	0.5W	5322	101	10315
R 1474	22K	20	0.5W	5322	101	10311
R 1476	330	20	0.5W	5322	101	10313
R 15	22K	20	0.1W	5322	101	20693
R 1501	5,11	1	MR25	5322	116	54192
R 1502	100	1	MR25	5322	116	55549
R 1503	24,9K	1	MR25	5322	116	54648
R 1504	22K	20	0.5W	5322	100	10118
R 1505	5,11	1	MR25	5322	116	54192
R 1506	402	1	MR25	5322	116	54519
R 1507	511	1	MR25	4822	116	51282
R 1508	6,49K	1	MR25	5322	116	54603
R 1509	511	1	MR25	4822	116	51282
R 1511	40,2K	1	MR25	5322	116	54665
R 1512	348K	1	MR25	5322	116	55499
R 1513	8,66K	1	MR25	5322	116	54613
R 1514	1,87K	1	MR25	5322	116	50728
R 1516	5,11	1	MR25	5322	116	54192
R 1517	36,5K	1	MR25	5322	116	50726
R 1519	249	1	MR25	5322	116	54499
R 1520	7,5K	1	MR25	5322	116	54608

ORDERING CODE

R 1521	7,5K	1	MR25	5322	116	54608
R 1522	511	1	MR25	4822	116	51282
R 1523	909	1	MR25	5322	116	55278
R 1524	23,7K	1	MR25	5322	116	54646
R 1526	100	1	MR25	5322	116	55549
R 1527	7,87K	1	MR25	5322	116	50458
R 1528	20,5K	1	MR25	5322	116	54643
R 1529	12,1K	1	MR25	5322	116	50572
R 1532	100K	1	MR25	4822	116	51268
R 1533	46,4K	1	MR25	5322	116	50557
R 1536	100	1	MR25	5322	116	55549
R 1537	383K	1	MR25	5322	116	55335
R 1538	1M	1	MR25	5322	116	55535
R 1539	511K	1	MR25	5322	116	55258
R 1541	78,7K	1	MR25	5322	116	50533
R 1542	100K	1	MR25	4822	116	51268
R 1543	59K	1	MR25	5322	116	54678
R 1544	5,11K	1	MR25	5322	116	54595
R 1546	1K	1	MR25	4822	116	51235
R 1547	6,81K	0,1	MR24E	5322	116	54165
R 1548	909	1	MR25	5322	116	55278
R 1549	1,47K	0,1	MR24E	5322	116	54187
R 1551	1	1	MR25	4822	116	51179
R 1552	133	1	MR25	5322	116	54482
R 1553	1K	1	MR25	4822	116	51235
R 16	22K	20	0.1W	5322	101	40107
R 17	5,11K	1	MR25	5322	116	54595
R 2	10K	20	0.1W	5322	101	40097
R 201	12,1K	1	MR25	5322	116	50572
R 202	2,05K	1	MR25	5322	116	50664
R 204	2,15K	1	MR25	5322	116	50767
R 205	511K	1	MR25	5322	116	55258
R 206	6,19K	1	MR25	5322	116	55426
R 207	2,15K	1	MR25	5322	116	50767
R 208	1K	1	MR25	4822	116	51235
R 209	9,09K	1	MR25	4822	116	51284
R 211	9,53K	1	MR25	5322	116	54617
R 212	2,37K	1	MR25	5322	116	54576
R 214	5,11	1	MR25	5322	116	54192
R 216	30,1	1	MR25	5322	116	50904
R 217	237	1	MR25	5322	116	50679
R 218	6,19K	1	MR25	5322	116	55426
R 219	3,48K	1	MR25	5322	116	55367
R 220	1K	1	MR25	4822	116	51235
R 221	1,54K	1	MR25	5322	116	50586
R 222	15,4K	1	MR25	5322	116	55459
R 223	15,4K	1	MR25	5322	116	55459
R 224	6,19K	1	MR25	5322	116	55426
R 226	10K	1	MR25	4822	116	51253
R 227	17,8K	1	MR25	5322	116	54637
R 228	15,4K	1	MR25	5322	116	55459
R 229	10K	1	MR25	4822	116	51253
R 230	15,4K	1	MR25	5322	116	55459
R 231	6,19K	1	MR25	5322	116	55426
R 232	1,69K	1	MR25	5322	116	54567
R 233	5,11	1	MR25	5322	116	54192
R 234	5,11	1	MR25	5322	116	54192
R 236	464	1	MR25	5322	116	50536
R 237	3,01K	1	MR25	4822	116	51246
R 238	3,01K	1	MR25	4822	116	51246

ORDERING CODE

R 239	715	1	MR25	5322	116	50571
R 240	51,1	1	MR25	5322	116	54442
R 241	33,2K	1	MR25	4822	116	51259
R 242	5,11K	1	MR25	5322	116	54595
R 243	5,11K	1	MR25	5322	116	54595
R 244	5,11K	1	MR25	5322	116	54595
R 246	5,11K	1	MR25	5322	116	54595
R 247	5,11K	1	MR25	5322	116	54595
R 248	48,7	1	MR25	5322	116	50511
R 249	750	1	MR25	4822	116	51234
R 250	100	1	MR25	5322	116	55549
R 251	5,11	1	MR25	5322	116	54192
R 252	5,11	1	MR25	5322	116	54192
R 253	100	1	MR25	5322	116	55549
R 254	511	1	MR25	4822	116	51282
R 255	511	1	MR25	4822	116	51282
R 256	5,11	1	MR25	5322	116	54192
R 257	30,1	1	MR25	5322	116	50904
R 258	825	1	MR25	5322	116	54541
R 259	30,1	1	MR25	5322	116	50904
R 260	6,81K	1	MR25	4822	116	51252
R 261	5,11	1	MR25	5322	116	54192
R 262	22K	20	0.5W	5322	101	14069
R 263	2,87K	1	MR25	5322	116	50414
R 264	6,81K	1	MR25	4822	116	51252
R 265	1,87K	1	MR25	5322	116	50728
R 266	6,19K	1	MR25	5322	116	55426
R 267	1K	1	MR25	4822	116	51235
R 268	22K	20	0.5W	5322	101	14069
R 269	154	1	MR25	5322	116	50506
R 271	33,2K	1	MR25	4822	116	51259
R 272	5,11K	1	MR25	5322	116	54595
R 273	33	5	CR16	4822	111	30067
R 274	5,11	1	MR25	5322	116	54192
R 275	100	1	MR25	5322	116	55549
R 276	40,2	1	MR25	5322	116	50926
R 277	1,33K	1	MR25	5322	116	55422
R 278	5,11	1	MR25	5322	116	54192
R 279	7,5	1	MR25	5322	116	54417
R 280	33	5	CR16	4822	111	30067
R 281	33	5	CR16	4822	111	30067
R 282	562	1	MR25	4822	116	51231
R 283	3,01K	1	MR25	4822	116	51246
R 284	3,01K	1	MR25	4822	116	51246
R 285	7,5	1	MR25	5322	116	54417
R 286	562	1	MR25	4822	116	51231
R 287	30,1	1	MR25	5322	116	50904
R 288	5,11	1	MR25	5322	116	54192
R 289	30,1	1	MR25	5322	116	50904
R 290	6,81K	1	MR25	4822	116	51252
R 291	5,11	1	MR25	5322	116	54192
R 292	3,65K	1	MR25	5322	116	54587
R 293	33,2K	1	MR25	4822	116	51259
R 294	1,87K	1	MR25	5322	116	50728
R296		1K78/MR25				5322 116 50515
R 297	5,11	1	MR25	5322	116	54192
R 298	5,11	1	MR25	5322	116	54192
R 299	5,11K	1	MR25	5322	116	54595
R 3	47K +47K	LIN	0,1W	5322	103	50002
R 301	100	1	MR25	5322	116	55549

				ORDERING CODE		
R 306	154K	1	MR25	5322	116	54714
R 307	5,11	1	MR25	5322	116	54192
R 308	2,87K	1	MR25	5322	116	50414
R 309	1,27K	1	MR25	5322	116	50555
R 311	5,11K	1	MR25	5322	116	54595
R 312	5,11	1	MR25	5322	116	54192
R 317	154K	1	MR25	5322	116	54714
R 318	2,26K	1	MR25	5322	116	50675
R 319	2,26K	1	MR25	5322	116	50675
R 321	2,26K	1	MR25	5322	116	50675
R 322	154K	1	MR25	5322	116	54714
R 323	5,11	1	MR25	5322	116	54192
R 324	33,2K	1	MR25	4822	116	51259
R 325	5,11	1	MR25	5322	116	54192
R 326	3,01K	1	MR25	4822	116	51246
R 327	649	1	MR25	5322	116	54532
R 328	5,11	1	MR25	5322	116	54192
R 329	3,01K	1	MR25	4822	116	51246
R 331	51,1	1	MR25	5322	116	54442
R 332	5,11	1	MR25	5322	116	54192
E333		4K64/MR25				5322 116 50484
R334		3K83/MR25				5322 116 54589
R 336	5,11K	1	MR25	5322	116	54595
R 337	5,11K	1	MR25	5322	116	54595
R 338	30,1K	1	MR25	5322	116	54655
R 339	1,21K	1	MR25	5322	116	54557
R 341	5,11	1	MR25	5322	116	54192
R 342	590	1	MR25	5322	116	50561
R 343	825	1	MR25	5322	116	54541
R 344	6,19K	1	MR25	5322	116	55426
R 345	10M	5	VR25	4822	110	72214
R 346	6,19K	1	MR25	5322	116	55426
R 347	22K	20	0.5W	5322	101	14069
R 348	22K	20	0.5W	5322	101	14069
R 349	22K	20	0.5W	5322	101	14069
R 351	22K	20	0.5W	5322	101	14069
R 355	30,1	1	MR25	5322	116	50904
R 356	1,87K	1	MR25	5322	116	50728
R 357	10K	1	MR25	4822	116	51253
R 358	10K	1	MR25	4822	116	51253
R 359	30,1	1	MR25	5322	116	50904
R 360	5,11	1	MR25	5322	116	54192
R 361	2,26K	1	MR25	5322	116	50675
R 362	2,26K	1	MR25	5322	116	50675
R 363	33,2K	1	MR25	4822	116	51259
R 364	5,11K	1	MR25	5322	116	54595
R 365	5,11K	1	MR25	5322	116	54595
R 366	1,15K	1	MR25	5322	116	50415
R 367	825	1	MR25	5322	116	54541
R 368	4,64K	1	MR25	5322	116	50484
R 369	7,87K	1	MR25	5322	116	50458
R 370	5,11	1	MR25	5322	116	54192
R 371	27,4K	1	MR25	5322	116	50559
R 372	19,6K	1	MR25	5322	116	54641
R 373	75K	1	MR25	4822	116	51267
R 374	59K	1	MR25	5322	116	54678
R 375	100	1	MR25	5322	116	55549
R 376	78,7K	1	MR25	5322	116	50533
R 377	61,9K	1	MR25	5322	116	50872
R 378	78,7K	1	MR25	5322	116	50533

ORDERING CODE

R 611	1,05K	1	MR25	5322	116	54552
R 612	1,33K	1	MR25	5322	116	55422
R 613	1,05K	1	MR25	5322	116	54552
R 614	365K	1	MR25	5322	116	55641
R 616	348K	1	MR25	5322	116	55499
R 617	10K	20	0.75W	5322	100	10141
R 618	2,26K	1	MR25	5322	116	50675
R 619	68,1K	1	MR25	5322	116	54683
R 621	115K	1	MR25	5322	116	54279
R 622	10K	20	0.75W	5322	100	10141
R 623	11K	1	MR25	5322	116	54623
R 624	1	1	MR25	4822	116	51179
R 626	2,49	1	MR25	5322	116	51394
R 627	1	1	MR25	4822	116	51179
R 631	18,7K	1	MR25	5322	116	55362
R 632	64,9K	1	MR25	5322	116	50514
R 633	1,05K	1	MR25	5322	116	54552
R 634	6,49K	1	MR25	5322	116	54603
R 636	3,32K	1	MR25	5322	116	54005
R 637	6,49K	1	MR25	5322	116	54603
R 638	3,32K	1	MR25	5322	116	54005
R 639	75K	1	MR25	4822	116	51267
R 641	18,7K	1	MR25	5322	116	55362
R 642	1,05K	1	MR25	5322	116	54552
R 643	5,11K	1	MR25	5322	116	54595
R 644	5,11K	1	MR25	5322	116	54595
R 646	5,11K	1	MR25	5322	116	54595
R 647	5,11K	1	MR25	5322	116	54595
R 648	5,11K	1	MR25	5322	116	54595
R 649	5,11K	1	MR25	5322	116	54595
R 651	10K	1	MR25	4822	116	51253
R 652	64,9	1	MR25	5322	116	54453
R 653	5,11K	1	MR25	5322	116	54595
R 654	3,01K	1	MR25	4822	116	51246
R 656	2,21K	1	MR25	4822	116	51245
R 657	48,7	1	MR25	5322	116	50511
R 658	10	1	MR25	5322	116	50452
R 659	10	1	MR25	5322	116	50452
R 660	47K	20	0.75W	5322	101	14056
R 661	75	1	MR25	5322	116	54459
R 662	162	1	MR25	5322	116	50417
R 663	162	1	MR25	5322	116	50417
R 664	100	1	MR25	5322	116	55549
R 666	511	1	MR25	4822	116	51282
R 668	237	1	MR25	5322	116	50679
R 669	511	1	MR25	4822	116	51282
R 671	100	1	MR25	5322	116	55549
R 672	619	1	MR25	4822	116	51232
R 673	619	1	MR25	4822	116	51232
R 674	51,1	1	MR25	5322	116	54442
R 676	51,1	1	MR25	5322	116	54442
R 677	10	1	MR25	5322	116	50452
R 678	10	1	MR25	5322	116	50452
R 679	51,1	1	MR25	5322	116	54442
R 681	68,1	1	MR25	5322	116	54455
R 682	68,1	1	MR25	5322	116	54455
R 683	619	1	MR25	4822	116	51232
R 684	348	1	MR25	5322	116	54515
R 686	348	1	MR25	5322	116	54515
R 687	68,1	1	MR25	5322	116	54455

ORDERING CODE

R 688	68,1	1	MR25	5322	116	54455
R 689	261	1	MR25	5322	116	54502
R 691	6,81K	1	MR25	4822	116	51252
R 692	12,1K	1	MR25	5322	116	50572
R 693	14,7K	1	MR25	5322	116	54632
R 694	110	1	MR25	5322	116	54474
R 7	10K	20	0.1W	5322	101	40096
R 701	1K	1	MR25	4822	116	51235
R 702	10	1	MR25	5322	116	50452
R 703	348	1	MR25	5322	116	54515
R 704	75	1	MR25	5322	116	54459
R 705	90,9	1	MR25	5322	116	54466
R 706	10	1	MR25	5322	116	50452
R 708	100	1	MR25	5322	116	55549
R 709	988K	0,5	MR30	5322	116	51401
R 711	8,35K	0,1	MR24E	5322	116	55148
R 712	23,7	1	MR25	5322	116	54014
R 713	172K	0,5	MR30	5322	116	51399
R 714	920K	0,5	MR30	5322	116	55218
R 716	92K	0,1	MR24E	5322	116	54875
R 717	23,7	1	MR25	5322	116	54014
R 718	825K	1	MR25	5322	116	51398
R 719	5,11	1	MR25	5322	116	54192
R 721	1M	1	MR25	5322	116	55535
R 722	511	1	MR25	4822	116	51282
R 723	5,11	1	MR25	5322	116	54192
R 724	51,1	1	MR25	5322	116	54442
R 726	51,1	1	MR25	5322	116	54442
R 727	1,96K	1	MR25	5322	116	54571
R 728	31,6	1	MR25	5322	116	54034
R 729	110	1	MR25	5322	116	54474
R 731	1K	1	MR25	4822	116	51235
R 732	825	1	MR25	5322	116	54541
R 733	162	1	MR25	5322	116	50417
R 734	4,02K	1	MR25	5322	116	55448
R 736	2,87K	1	MR25	5322	116	50414
R 737	6,49K	1	MR25	5322	116	54603
R 738	22K	20	0.5W	5322	101	14069
R 739	7,87K	1	MR25	5322	116	50458
R 741	22,6K	1	MR25	5322	116	50481
R 742	11K	1	MR25	5322	116	54623
R 743	825K	1	MR25	5322	116	51398
R 744	11,5	1	MR25	5322	116	50838
R 746	11,5	1	MR25	5322	116	50838
R 747	1K	20	0,5W	5322	100	10112
R 748	8,66K	1	MR25	5322	116	54613
R 749	12,1K	1	MR25	5322	116	50572
R 751	137	0,1	MR24E	5322	116	51402
R 752	205	0,1	MR24E	5322	116	51404
R 753	53,6	0,1	MR24E	5322	116	54997
R 754	82,5	0,1	MR24E	5322	116	51405
R 755	464	1	MR25	5322	116	50536
R 756	82,5	0,1	MR24E	5322	116	51405
R 757	1M	1	MR25	5322	116	55535
R 758	1M	1	MR25	5322	116	55535
R 759	1M	1	MR25	5322	116	55535
R 760	68,1	1	MR25	5322	116	54455
R 761	1M	1	MR25	5322	116	55535
R 762	1M	1	MR25	5322	116	55535
R 763	1M	1	MR25	5322	116	55535

ORDERING CODE

R 764	1M	1	MR25	5322	116	55535
R 766	1M	1	MR25	5322	116	55535
R 767	1M	1	MR25	5322	116	55535
R 768	1M	1	MR25	5322	116	55535
R 769	511	1	MR25	4822	116	51282
R 771	10K	20	0.75W	5322	100	10141
R 772	42,2K	1	MR25	5322	116	50474
R 773	4,02K	1	MR25	5322	116	55448
R 774	2,87K	1	MR25	5322	116	50414
R 776	215	1	MR25	5322	116	55274
R 777	90,9	1	MR25	5322	116	54466
R 778	90,9	1	MR25	5322	116	54466
R 779	470	20	0.75W	5322	100	10135
R 781	196	1	MR25	5322	116	55273
R 782	2,61K	1	MR25	5322	116	50671
R 783	10	1	MR25	5322	116	50452
R 784	82,5	1	MR25	5322	116	54462
R 786	1K	20	0.75W	5322	100	10143
R 787	121	1	MR25	5322	116	54426
R 788	1,33K	1	MR25	5322	116	55422
R 789	1,33K	1	MR25	5322	116	55422
R 791	100K	1	MR25	4822	116	51268
R 792	348	1	MR25	5322	116	54515
R 793	10K	1	MR25	4822	116	51253
R 794	14K	1	MR25	5322	116	55571
R 796	14,7	1	MR25	5322	116	50412
R 797	14,7	1	MR25	5322	116	50412
R 798	909	1	MR25	5322	116	55278
R 799	909	1	MR25	5322	116	55278
R 8	10K	20	0.1W	5322	101	40096
R 801	2,05K	1	MR25	5322	116	50664
R 802	147	1	MR25	5322	116	50766
R 803	147	1	MR25	5322	116	50766
R 804	220	20	0.75W	5322	100	10133
R 806	3,48K	1	MR25	5322	116	55367
R807			7K5/MR25			5322 116 54608
R 808	3,48K	1	MR25	5322	116	55367
R 809	1,33K	1	MR25	5322	116	55422
R 811	1,05K	1	MR25	5322	116	54552
R 812	1,33K	1	MR25	5322	116	55422
R 813	1,05K	1	MR25	5322	116	54552
R 814	365K	1	MR25	5322	116	55641
R 816	348K	1	MR25	5322	116	55499
R 817	10K	20	0.75W	5322	100	10141
R 818	2,26K	1	MR25	5322	116	50675
R 819	68,1K	1	MR25	5322	116	54683
R 821	115K	1	MR25	5322	116	54279
R 822	10K	20	0.75W	5322	100	10141
R 823	11K	1	MR25	5322	116	54623
R 824	649	1	MR25	5322	116	54532
R 826	3,3K	5	0.5W	5322	116	30234
R 827	487	1	MR25	5322	116	55451
R 828	215	1	MR25	5322	116	55274
R 831	42,2	1	MR25	5322	116	51052
R 832	42,2	1	MR25	5322	116	51052
R 833	215	1	MR25	5322	116	55274
R 834	5,11K	1	MR25	5322	116	54595
R 836	215	1	MR25	5322	116	55274
R 837	1,05K	1	MR25	5322	116	54552
R 838	5,11K	1	MR25	5322	116	54595

ORDERING CODE

R 839	1,05K	1	MR25	5322	116	54552
R 841	22K	20	0.5W	5322	101	14069
R 842	8,25K	1	MR25	5322	116	54558
R 843	274	1	MR25	5322	116	54504
R 844	51,1	1	MR25	5322	116	54442
R 846	619	1	MR25	4822	116	51232
R 847	348	1	MR25	5322	116	54515
R 848	619	1	MR25	4822	116	51232
R 849	51,1	1	MR25	5322	116	54442
R 868	100	1	MR25	5322	116	55549
R 869	100	1	MR25	5322	116	55549
R 871	100K	1	MR25	4822	116	51268
R870		1K/MR25				5322 116 54549
R 872	9,53K	1	MR25	5322	116	54617
R 873	536	1	MR25	5322	116	50621
R 874	30,1	1	MR25	5322	116	50904
R 875	100	1	MR25	5322	116	55549
R 876	422	1	MR25	5322	116	50459
R 877	464	1	MR25	5322	116	50536
R 878	40,2	1	MR25	5322	116	50926
R 879	40,2	1	MR25	5322	116	50926
R 880	100	1	MR25	5322	116	55549
R 881	2,49K	1	MR25	5322	116	50581
R 882	1,05K	1	MR25	5322	116	54552
R 883	3,01K	1	MR25	4822	116	51246
R 884	7,15K	1	MR25	5322	116	54606
R 886	1K	1	MR25	4822	116	51235
R 887	100	20	0.5W	5322	101	14011
R 888	1K	1	MR25	4822	116	51235
R 889	100	20	0.75W	5322	100	10138
R 891	10K	20	0.5W	5322	100	10113
R 892	909	1	MR25	5322	116	55278
R 893	1	1	MR25	4822	116	51179
R 894	100K	1	MR25	4822	116	51268
R 896	422	1	MR25	5322	116	50459
R 897	100	1	MR25	5322	116	55549
R 898	40,2	1	MR25	5322	116	50926
R 899	40,2	1	MR25	5322	116	50926
R 9	10K	20	0.1W	5322	101	40096
R 901	619	1	MR25	4822	116	51232
R 902	4,02K	1	MR25	5322	116	55448
R 903	5,11K	1	MR25	5322	116	54595
R 904	100K	1	MR25	4822	116	51268
R 906	100K	1	MR25	4822	116	51268
R 907	4,7K	20	0.75W	5322	100	10139
R 910	100	1	MR25	5322	116	55549
R 911	90,9K	1	MR25	5322	116	54694
R 912	10M	5	VR25	4822	110	72214
R 913	10M	5	VR25	4822	110	72214
R 914	59	1	MR25	5322	116	54448
R 917	59	1	MR25	5322	116	54448
R 918	750	1	MR25	4822	116	51234
R 919	48,7	1	MR25	5322	116	50511
R 921	48,7	1	MR25	5322	116	50511
R 922	48,7	1	MR25	5322	116	50511
R 923	48,7	1	MR25	5322	116	50511
R 924	59	1	MR25	5322	116	54448
R 927	750	1	MR25	4822	116	51234
R 928	59	1	MR25	5322	116	54448
R 929	2,49	1	MR25	5322	116	51394
R930		422E/MR25				5322 116 50459

ORDERING CODE

R931		619E/MR25		5322 116 55283	5322 116 54529
R 932	402K	1	MR25	5322 116 55283	
R 933	536	1	MR25	5322 116 50621	
R 934	30,1	1	MR25	5322 116 50904	
R 936	100	1	MR25	5322 116 55549	
R 937	287	1	MR25	5322 116 54506	
R 938	46,4	1	MR25	5322 116 50492	
R 939	464	1	MR25	5322 116 50536	
R 940	5,11K	1	MR25	5322 116 54595	
R 941	14,7	1	MR25	5322 116 50412	
R 942	48,7	1	MR25	5322 116 50511	
R 943	562	1	MR25	4822 116 51231	
R 944	48,7	1	MR25	5322 116 50511	
R 945	100	1	MR25	5322 116 55549	
R 946	1,69K	1	MR25	5322 116 54567	
R 947	1,27K	1	MR25	5322 116 50555	
R 948	487	1	MR25	5322 116 55451	
R 949	100K	1	MR25	4822 116 51268	
R 950	1K	1	MR25	4822 116 51235	
R 951	2,49K	1	MR25	5322 116 50581	
R 952	7,15K	1	MR25	5322 116 54606	
R 953	105K	1	MR25	5322 116 54698	
R 954	4,22K	1	MR25	5322 116 50729	
R 955	14,7	1	MR25	5322 116 50412	
R 956	12,7K	1	MR25	5322 116 50443	
R 957	8,25K	1	MR25	5322 116 54558	
R 958	220	20	0.75W	5322 100 10133	
R 959	220	20	0,5W	5322 101 14009	
R 960	162	1	MR25	5322 116 50417	
R 961	220	20	0.75W	5322 100 10133	
R 962	220	20	0,5W	5322 101 14009	
R 963	100	1	MR25	5322 116 55549	
R 964	100	20	0,5W	5322 101 14011	
R 965	21,5	1	MR25	5322 116 50677	
R 966	100	1	MR25	5322 116 55549	
R 967	2,49	1	MR25	5322 116 51394	
R 968	48,7	1	MR25	5322 116 50511	
R 969	5,11K	1	MR25	5322 116 54595	
R 970	100K	1	MR25	4822 116 51268	
R 971	5,11K	1	MR25	5322 116 54595	
R 972	2,37K	1	MR25	5322 116 54576	
R 973	562	1	MR25	4822 116 51231	
R 974	51,1K	1	MR25	5322 116 50672	
R 975	21,5	1	MR25	5322 116 50677	
R 976	866	1	MR25	5322 116 54543	
R 977	4,02K	1	MR25	5322 116 55448	
R 978	3,01K	1	MR25	4822 116 51246	
R 979	1K	1	MR25	4822 116 51235	
R 980	51,1K	1	MR25	5322 116 50672	
R 981	1,78K	1	MR25	5322 116 50515	
R 982	10K	1	MR25	4822 116 51253	
R 983	5,11K	1	MR25	5322 116 54595	
R 984	2,2M	5	VR25	4822 110 72196	
R 986	511	1	MR25	4822 116 51282	
R 987	316	1	MR25	5322 116 54511	
R 988	511	1	MR25	4822 116 51282	
R 989	511	1	MR25	4822 116 51282	
R 991	316	1	MR25	5322 116 54511	
R 992	511	1	MR25	4822 116 51282	
R 993	100K	1	MR25	4822 116 51268	
R 994	26,1K	1	MR25	5322 116 54651	
R 995	26,1K	1	MR25	5322 116 54651	
R 996	287	1	MR25	5322 116 54506	
R 997	511	1	MR25	4822 116 51282	
R 998	56,2	1	MR25	5322 116 54446	
R 999	14,7	1	MR25	5322 116 50412	

ORDERING CODE

T 1401			5322	142	60329
T 1402			5322	148	80046
T 1403			5322	142	70065
T 1404			5322	158	40085
T 1406			5322	146	30434
T 801	TRANSFORMER ASSY		5322	142	50147
V 1	D14-125GH/117		5322	131	20093
V 1101	BC548C	PH	4822	130	44196
V 1102	BF199	PH	4822	130	44154
V 1103	BF199	PH	4822	130	44154
V 1104	BFS21A	PH	5322	130	40709
V 1106	BAV45	PH	5322	130	34037
V 1203	BC558B	PH	4822	130	44197
V 1204	BFQ24	PH	5322	130	41664
V 1205	BAW62	PH	4822	130	30613
V 1206	BFQ24	PH	5322	130	41664
V 1207	BB405B	PH	5322	130	34953
V 1208	BB405B	PH	5322	130	34953
V 1209	BFQ24	PH	5322	130	41664
V 1211	BFQ24	PH	5322	130	41664
V 1212	BC548C	PH	4822	130	44196
V 1213	BFQ22S	PH	5322	130	42031
V 1214	BFQ22S	PH	5322	130	42031
V 1302	BF422	PH	4822	130	41782
V 1303	BF423	PH	4822	130	41646
V 1306	BFQ24	PH	5322	130	41664
V 1307	BFQ22	PH	5322	130	41709
V 1308	BAW62	PH	4822	130	30613
V 1309	BAW62	PH	4822	130	30613
V 1311	BF423	PH	4822	130	41646
V 1312	BF422	PH	4822	130	41782
V 1313	BF422	PH	4822	130	41782
V 1314	BF423	PH	4822	130	41646
V 1316	BF423	PH	4822	130	41646
V 1317	BF422	PH	4822	130	41782
V 1318	BAW62	PH	4822	130	30613
V 1319	BAW62	PH	4822	130	30613
V 1371	BF324	PH	4822	130	41448
V 1372	BF324	PH	4822	130	41448
V 1373	BC558B	PH	4822	130	44197
V 1374	BC548C	PH	4822	130	44196
V 1401	BSW68A	PH	5322	130	44788
V 1402	BAX12A	PH	5322	130	34605
V 1403	BY476	PH	5322	130	34668
V 1404	BC547B	PH	4822	130	40959
V 1405	BAW62	PH	4822	130	30613
V 1406	BC547B	PH	4822	130	40959
V 1407	BAS11	PH	4822	130	41273
V 1408	BZV10	PH	5322	130	34439
V 1409	BYW29-150	PH	5322	130	34711
V 1410	BAW62	PH	4822	130	30613
V 1411	BAS11	PH	4822	130	41273
V 1412	BYW29-150	PH	5322	130	34711
V 1413	BDY90	PH	5322	130	44243
V 1414	BYW29-150	PH	5322	130	34711
V 1415	BAS11	PH	4822	130	41273
V 1416	BAS11	PH	4822	130	41273
V 1417	BAS11	PH	4822	130	41273
V 1418	BAS11	PH	4822	130	41273
V 1419	BAS11	PH	4822	130	41273
V 1421	BAW62	PH	4822	130	30613
V 1422	BZX79-C10	PH	4822	130	34297
V 1423	BZX79-C6V2	PH	4822	130	31111
V 1424	BZX79-C12	PH	4822	130	34197
V 1426	BAW62	PH	4822	130	30613

ORDERING CODE

V 1427	BAW62	PH	4822	130	30613
V 1428	BC547B	PH	4822	130	40959
V 1429	BC547B	PH	4822	130	40959
V 1432	BAW62	PH	4822	130	30613
V 1433	BC547B	PH	4822	130	40959
V 1434	BAW62	PH	4822	130	30613
V 1436	BYW29-150	PH	5322	130	34711
V 1437	BAX12A	PH	5322	130	34605
V 1438	2N4033	PH	5322	130	41708
V 1439	BYW29-150	PH	5322	130	34711
V 1441	BYW29-150	PH	5322	130	34711
V 1442	BYW29-150	PH	5322	130	34711
V 1501	BC548C	PH	4822	130	44196
V 1502	BC558B	PH	4822	130	44197
V 1503	BSX20	PH	4822	130	41705
V 1504	BC558B	PH	4822	130	44197
V 1507	BAV21	PH	4822	130	30842
V 1508	BSS68	PH	5322	130	44247
V 1509	BC548C	PH	4822	130	44196
V 1511	BF450	PH	4822	130	44237
V 1512	BC548C	PH	4822	130	44196
V 1513	BF199	PH	4822	130	44154
V 1514	BAV21	PH	4822	130	30842
V 1516	BC548C	PH	4822	130	44196
V 2	BD938	PH	5322	130	42029
V 200	BC558B	PH	4822	130	44197
V 201	BAW62	PH	4822	130	30613
V 202	BZX79-C3V0	PH	4822	130	31251
V 203	BC558B	PH	4822	130	44197
V 204	BC558B	PH	4822	130	44197
V 205	BAW62	PH	4822	130	30613
V 206	BAW62	PH	4822	130	30613
V 207	BC548C	PH	4822	130	44196
V 208	BC558B	PH	4822	130	44197
V 209	BC548C	PH	4822	130	44196
V 211	BAW62	PH	4822	130	30613
V 212	BFQ24	PH	5322	130	41664
V 213	BC558B	PH	4822	130	44197
V 214	BAW62	PH	4822	130	30613
V 216	BAW62	PH	4822	130	30613
V 217	BAW62	PH	4822	130	30613
V 218	BAW62	PH	4822	130	30613
V 219	BC548C	PH	4822	130	44196
V 220	BAW62	PH	4822	130	30613
V 221	BC548C	PH	4822	130	44196
V 222	BAW62	PH	4822	130	30613
V 223	BC558B	PH	4822	130	44197
V 224	BC558B	PH	4822	130	44197
V 225	BF324	PH	4822	130	41448
V 226	BF324	PH	4822	130	41448
V 227	BSX20	PH	4822	130	41705
V 228	BSX20	PH	4822	130	41705
V 229	BC558B	PH	4822	130	44197
V 230	BA280	PH	5322	130	34302
V 231	BC548C	PH	4822	130	44196
V 232	BAW62	PH	4822	130	30613
V 233	BSX20	PH	4822	130	41705
V 234	BSX20	PH	4822	130	41705
V 235	BC548C	PH	4822	130	44196
V 236	BC558B	PH	4822	130	44197

ORDERING CODE

V 237	BC548C	PH	4822 130 44196	
V 238	BC548C	PH	4822 130 44196	
V 239	BAW62	PH	4822 130 30613	
V 240	BAW62	PH	4822 130 30613	
V 241	BAW62	PH	4822 130 30613	
V 242	BAW62	PH	4822 130 30613	
V 243	BAW62	PH	4822 130 30613	
V 244	BAW62	PH	4822 130 30613	
V 245	BAW62	PH	4822 130 30613	
V 246	BC548C	PH	4822 130 44196	
V 247	BC548C	PH	4822 130 44196	
V 248	BC548C	PH	4822 130 44196	
V 249	BAW62	PH	4822 130 30613	
V 250	BAW62	PH	4822 130 30613	
V 251	BAW62	PH	4822 130 30613	
V 252	BAW62	PH	4822 130 30613	
V 253	BA280	PH	5322 130 34302	
V 254	BAW62	PH	4822 130 30613	
V 255	BAW62	PH	4822 130 30613	
V 256	BC548C	PH	4822 130 44196	
V 257	BC548C	PH	4822 130 44196	
V 258	BC548C	PH	4822 130 44196	
V 259	BC548C	PH	4822 130 44196	
V260		BZX79/C6V8		4822 130 34278
V 261	BC558B	PH	4822 130 44197	
V 262	BAW62	PH	4822 130 30613	
V 263	BAW62	PH	4822 130 30613	
V 264	BC558B	PH	4822 130 44197	
V 265	BAW62	PH	4822 130 30613	
V 266	BZV46-C1V5	PH	5322 130 34865	
V 268	BC548C	PH	4822 130 44196	
V 269	BC548C	PH	4822 130 44196	
V 271	BSX20	PH	4822 130 41705	
V 272	BC548C	PH	4822 130 44196	
V 273	BC548C	PH	4822 130 44196	
V 274	BAW62	PH	4822 130 30613	
V 276	BAW62	PH	4822 130 30613	
V 277	BAW62	PH	4822 130 30613	
V 278	BAW62	PH	4822 130 30613	
V 279	BAW62	PH	4822 130 30613	
V 281	BAW62	PH	4822 130 30613	
V 282	BAW62	PH	4822 130 30613	
V 283	BAW62	PH	4822 130 30613	
V 284	BC548C	PH	4822 130 44196	
V 285	BC548C	PH	4822 130 44196	
V 286	BC548C	PH	4822 130 44196	
V 287	BC548C	PH	4822 130 44196	
V 288	BFY90	PH	4822 130 40493	
V 289	BFY90	PH	4822 130 40493	
V 291	BF324	PH	4822 130 41448	
V 292	BFQ24	PH	5322 130 41664	
V 293	BF324	PH	4822 130 41448	
V 294	BAW62	PH	4822 130 30613	
V 295	BAW62	PH	4822 130 30613	
V 296	BA280	PH	5322 130 34302	
V 297	BA280	PH	5322 130 34302	
V 298	BAW62	PH	4822 130 30613	
V 299	BAW62	PH	4822 130 30613	
V 300	BAW62	PH	4822 130 30613	
V 301	BAW62	PH	4822 130 30613	

ORDERING CODE

V 501	ON905	PH	5322 130 41904
V 502	BZX79-C5V6	PH	4822 130 34173
V 503	BF324	PH	4822 130 41448
V 504	BFW30	PH	5322 130 40379
V 506	BC558B	PH	4822 130 44197
V 507	BF199	PH	4822 130 44154
V 508	BF199	PH	4822 130 44154
V 509	BC548C	PH	4822 130 44196
V 511	BC548C	PH	4822 130 44196
V 512	BZX79-B6V8	PH	4822 130 34278
V 513	BC558B	PH	4822 130 44197
V 514	BZV46-C2V0	PH	4822 130 31248
V 516	24		5322 130 41993
V 518	BAW62	PH	4822 130 30613
V 519	BF450	PH	4822 130 44237
V 521	BC548C	PH	4822 130 44196
V 631	BC548C	PH	4822 130 44196
V 632	BSX20	PH	4822 130 41705
V 633	BFQ24	PH	5322 130 41664
V 634	BFQ24	PH	5322 130 41664
V 636	BFQ22S	PH	5322 130 42031
V 637	BFQ22S	PH	5322 130 42031
V 701	ON905	PH	5322 130 41904
V 702	BZX79-C5V6	PH	4822 130 34173
V 703	BF324	PH	4822 130 41448
V 704	BFW30	PH	5322 130 40379
V 706	BC558B	PH	4822 130 44197
V 707	BF199	PH	4822 130 44154
V 708	BF199	PH	4822 130 44154
V 709	BC548C	PH	4822 130 44196
V 711	BC548C	PH	4822 130 44196
V 712	BZX79-B6V8	PH	4822 130 34278
V 713	BC558B	PH	4822 130 44197
V 714	BZV46-C2V0	PH	4822 130 31248
V 716	24		5322 130 41993
V 718	BAW62	PH	4822 130 30613
V 719	BF450	PH	4822 130 44237
V 721	BC548C	PH	4822 130 44196
V 722	BC548C	PH	4822 130 44196
V 831	BF324	PH	4822 130 41448
V 832	BF324	PH	4822 130 41448
V 833	BFQ22S	PH	5322 130 42031
V 834	BFQ22S	PH	5322 130 42031
V 851	BFQ24	PH	5322 130 41664
V 852	BF450	PH	4822 130 44237
V 853	BF450	PH	4822 130 44237
V 854	BFQ24	PH	5322 130 41664
V856	BC558B		4822 130 44197
V 857	BAW62	PH	4822 130 30613
V 858	BAW62	PH	4822 130 30613
V 859	BC548C	PH	4822 130 44196
V 860	BAW62	PH	4822 130 30613
V 861	BF199	PH	4822 130 44154
V 862	BF199	PH	4822 130 44154
V 863	BC558B	PH	4822 130 44197
V 864	BC548C	PH	4822 130 44196
V 865	BF199	PH	4822 130 44154
V 866	BC548C	PH	4822 130 44196
V 867	BA280	PH	5322 130 34302
V 868	BA280	PH	5322 130 34302

ORDERING CODE

V 869	BF199	PH	4822 130 44154
V 870	BC548C	PH	4822 130 44196
V 871	BC548C	PH	4822 130 44196
V 872	BF199	PH	4822 130 44154
V 873	BF199	PH	4822 130 44154
V 874	BF199	PH	4822 130 44154
V 875	BC548C	PH	4822 130 44196
V 876	BF199	PH	4822 130 44154
V 877	BZX79-C4V7	PH	4822 130 34174
V 878	BF199	PH	4822 130 44154
V 879	BF199	PH	4822 130 44154
V 880	BC548C	PH	4822 130 44196
V 881	BZX79-C6V2	PH	4822 130 31111
V 882	BF199	PH	4822 130 44154
V 883	BF199	PH	4822 130 44154
V 884	BAW62	PH	4822 130 30613
V 885	BZX79-C4V7	PH	4822 130 34174
V 887	BFS21A	PH	5322 130 40709
V 888	BAW62	PH	4822 130 30613
V 889	BAW62	PH	4822 130 30613
V 890	BZX79-C6V8	PH	4822 130 34278
V 891	BAW62	PH	4822 130 30613
V 892	BAW62	PH	4822 130 30613
V 893	BC548C	PH	4822 130 44196
V 894	BAW62	PH	4822 130 30613
V 895	BF199	PH	4822 130 44154
V 896	BC548C	PH	4822 130 44196
V 897	BC548C	PH	4822 130 44196
V 898	BC548C	PH	4822 130 44196
V 899	BC548C	PH	4822 130 44196
V 901	BAW62	PH	4822 130 30613
V 902	BAW62	PH	4822 130 30613
V 903	BAW62	PH	4822 130 30613
V 904	BAW62	PH	4822 130 30613
V 906	BAW62	PH	4822 130 30613
V 907	BC548C	PH	4822 130 44196
V 908	BC558B	PH	4822 130 44197
V 909	BC548C	PH	4822 130 44196
V 910	BAW62	PH	4822 130 30613
V 912	BF450	PH	4822 130 44237
V 913	BF450	PH	4822 130 44237
V 914	BF450	PH	4822 130 44237
V 916	BF450	PH	4822 130 44237
V 917	BF450	PH	4822 130 44237
V 918	BF450	PH	4822 130 44237
V 919	BFS21A	PH	5322 130 40709
V 921	BF450	PH	4822 130 44237
V 922	BF450	PH	4822 130 44237
V 923	BFQ24	PH	5322 130 41664
V 924	BFQ24	PH	5322 130 41664

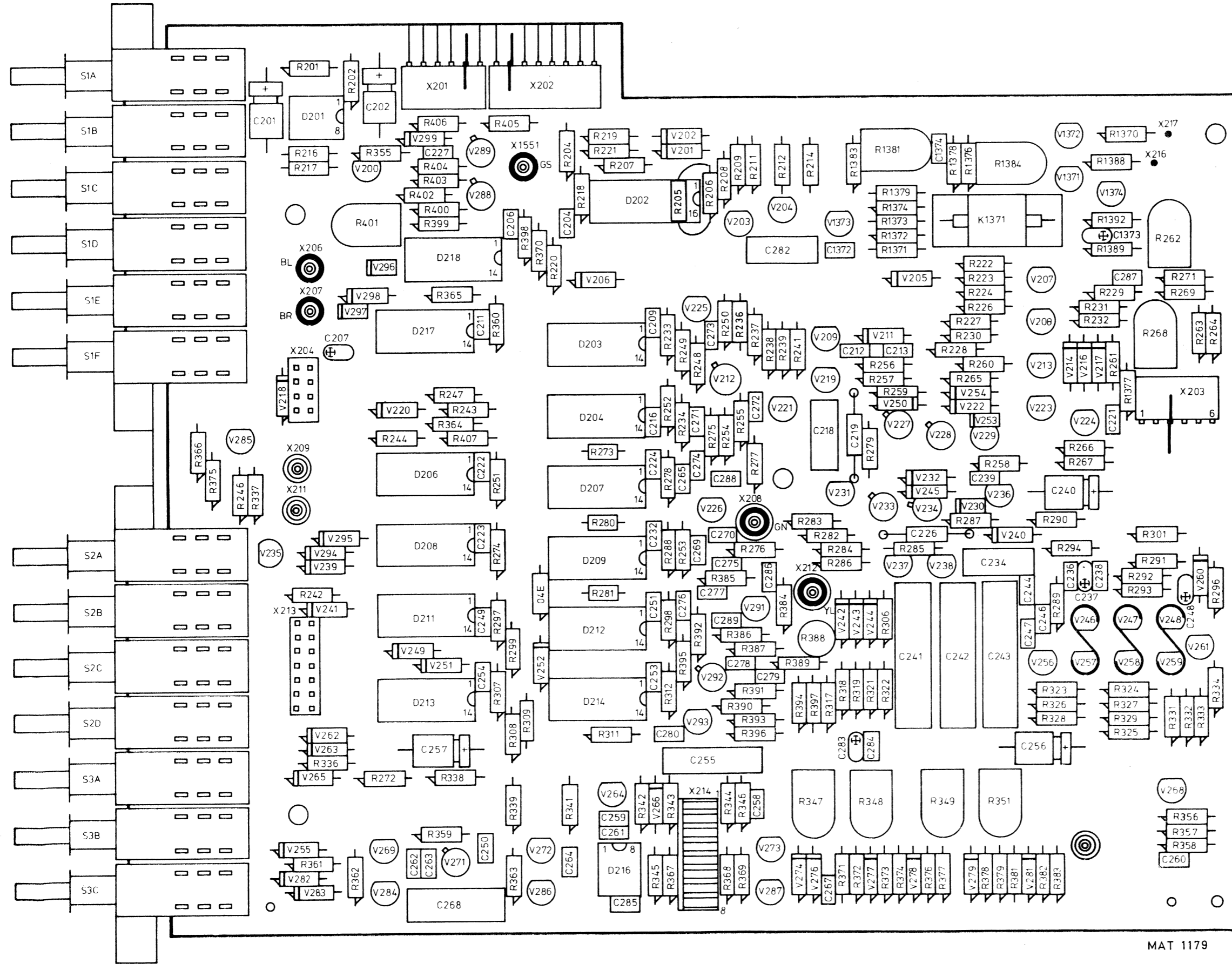

Capacitors

C201	A11
C202	A11
C203	A12
C204	B13
C206	B13
C207	C12
C208	B15
C209	C14
C211	B13/C13
C212	C15
C213	C15
C216	C14
C218	C15
C219	C15
C221	C17
C222	D13/C13
C223	D13
C224	D14/C14
C226	D15/D16
C227	A12
C232	D14
C234	D16
C236	D16
C237	D16
C238	D17/D16
C240	C17
C241	D16/E15
C242	D16/E16
C243	D16/E16
C244	D16
C246	D16
C247	D16/E16
C248	D17
C249	D13/E13
C250	F13
C251	D14
C252	F17
C253	E14
C254	E13
C255	E14
C256	E16
C257	E12
C258	F14
C259	F13
C260	F17
C261	F13
C262	F12
C263	F12
C264	F13
C265	D14/C14
C266	F17
C267	F15
C268	F12/F13
C269	D14
C270	D14

Fig. 1.7. Time-base unit p.c.b. with component location raster

MAT 1179

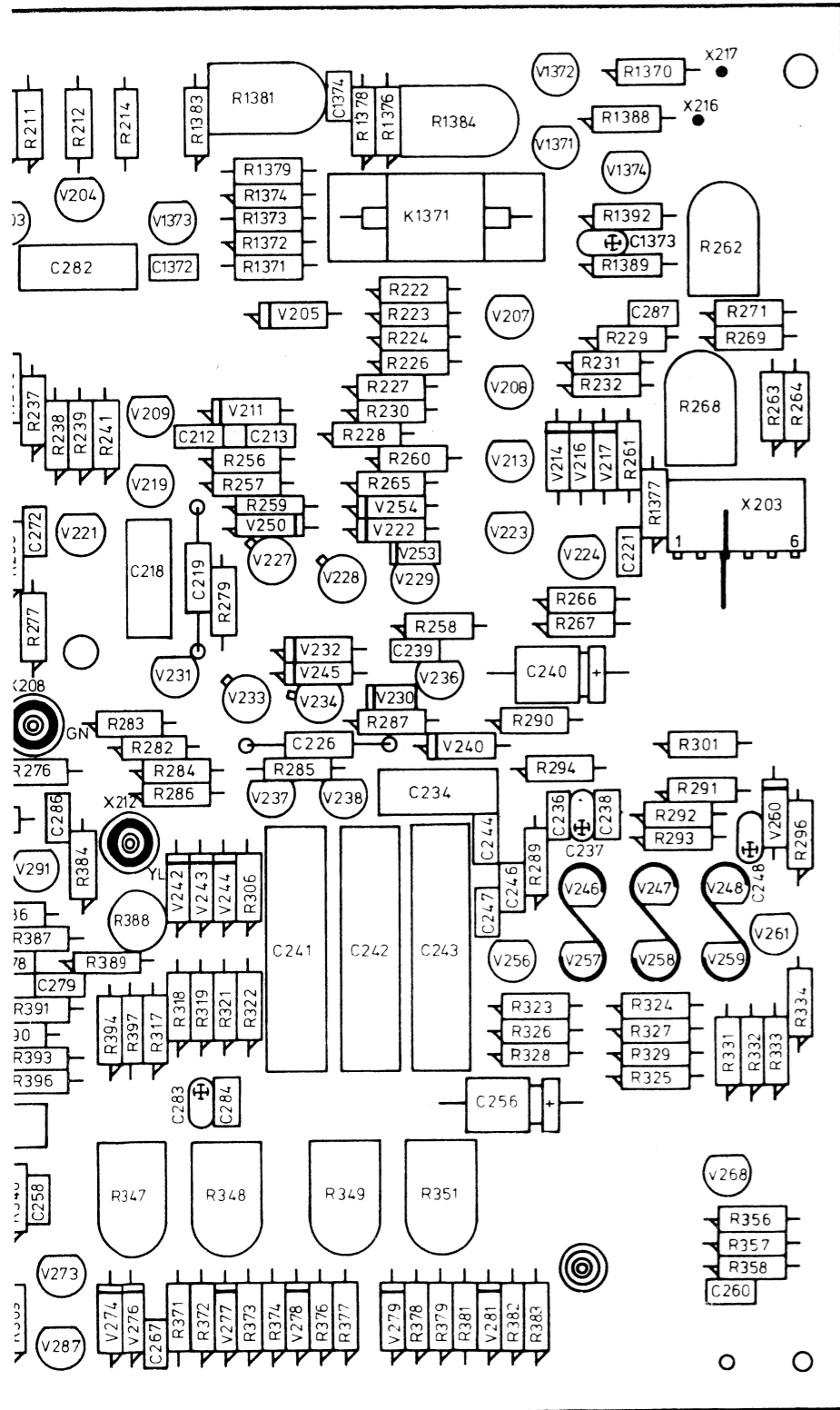

MAT 1179

Capacitors

C201	A11
C202	A11
C203	A12
C204	B13
C206	B13
C207	C12
C208	B15
C209	C14
C211	B13/C13
C212	C15
C213	C15
C216	C14
C218	C15
C219	C15
C221	C17
C222	D13/C13
C223	D13
C224	D14/C14
C226	D15/D16
C227	A12
C232	D14
C234	D16
C236	D16
C237	D16
C238	D17/D16
C240	C17
C241	D16/E15
C242	D16/E16
C243	D16/E16
C244	D16
C246	D16
C247	D16/E16
C248	D17
C249	D13/E13
C250	F13
C251	D14
C252	F17
C253	E14
C254	E13
C255	E14
C256	E16
C257	E12
C258	F14
C259	F13
C260	F17
C261	F13
C262	F12
C263	F12
C264	F13
C265	D14/C14
C266	F17
C267	F15
C268	F12/F13
C269	D14
C270	D14

7.4. LOCATION LIST OF PARTS SITUATED ON THE TIME-BASE UNIT A2 (see Fig. 7.7)

C271	C14	R216	A11	R276	D14
C272	C14	R217	A11/B11	R277	D14/C14
C273	C14	R218	B13	R278	D14/C14
C274	C14/D14	R219	A13	R279	C15
C275	D14	R220	B13	R282	D15
C276	D14	R221	A13	R283	D15
C277	D14	R222	B16	R284	D15
C278	E14	R223	B16	R285	D15
C279	E14	R224	B16	R286	D15
C280	E14	R226	B16	R287	D16
C282	B15/B14	R227	C16	R288	D14
C283	E14	R228	C16	R289	D16
C284	E14	R229	B17	R290	D16 (TS)
C286	D14	R230	C16	R291	D17
C287	B17	R231	B16/B17	R292	D17
C288	D14	R232	C16/C17	R293	D17
C289	D14	R233	C14	R294	D17 and D16 (TS)
C1372	B15	R234	C14	R296	D17
C1373	B16	R236	B14/C14	R297	D13/E13
C1374	A15	R237	C14	R298	D14/E14
		R238	C14	R299	E13
		R239	C14	R300	E12
		R241	C15	R301	D17
		R242	F12	R306	D15/E12
		R243	C12/C13	R307	E13
		R244	C12	R308	E13
		R246	D11	R309	E13
		R247	C12	R311	E13
		R248	C14	R312	E14
		R249	C14	R317	E15
		R250	B14/C14	R318	E15
		R251	D13/C13	R319	E15
		R252	C14	R321	E15
		R253	D14	R322	E15
		R254	C14	R323	E16
		R255	C14	R324	E17
		R256	C15	R325	E17
		R257	C15	R326	E16
		R258	C16	R327	E17
		R259	C15	R328	E16
		R260	C16 (TS)	R329	E17
		R261	C17	R331	E17
		R262	B17	R332	E17
		R263	C17	R333	E17
		R264	C17	R334	E17
		R265	C16 (TS)	R336	E11/E12
		R266	C16	R337	D11
		R267	C16	R338	E12
		R268	C17	R339	F13
		R269	B17	R341	F13
		R271	B17	R342	F14
		R272	E12	R343	F14
		R274	D13	R344	F14
		R275	C14	R345	F14

(TS) = located on track side

R347	F15	R404	B12/A12	V239	D11/D12
R348	F15	R405	A13	V240	D16 (TS)
R349	F16/F15	R406	A12	V241	D11/D12
R351	F16	R407	C12/C13	V242	D15/E15
R352	F16	R1370	A17	V243	D15/E15
R353	F16	R1371	B15	V244	D15/E15
R354	F16	R1372	B15	V245	D15 (TS)
R355	A12	R1373	B15	V246	D16
R356	F17	R1374	B15	V247	D17
R357	F17	R1376	A16/B16	V248	D17
R358	F17	R1377	C17	V249	E12
R359	F12	R1378	A16/B16	V250	C15 (TS)
R360	C13/B13	R1379	A15/B15	V251	E12
R361	F11	R1381	A15/B15	V252	E13
R362	F12	R1383	A15/B15	V253	C16 (TS)
R363	F13	R1384	A16/B16	V254	C16 (TS)
R364	C12	R1388	A17/B17	V255	F11
R365	B12	R1389	B17	V256	E16
R366	C11	R1392	B17	V257	E16
R367	F14	V200	B12/A12	V258	E17
R368	F14	V201	A14	V259	E17
R369	F14	V202	A14	V260	D17
R370	B13	V203	B14	V261	E17
R371	F15	V204	B14	V262	E11/E12
R372	F15	V205	B14	V263	E11/E12
R373	F15	V206	B13	V264	F13
R374	F15	V207	B16	V265	E11
R375	C11	V208	C16	V266	F14
R376	F15	V209	C15	V267	F17
R377	F16/F15	V211	C15	V268	F17
R378	F16	V212	C14	V269	F12
F379	F16	V213	C16	V271	F12
R381	F16	V214	C16	V272	F13
R382	F16	V216	C16	V273	F14
R383	F16	V217	C16/C17	V274	F15
R384	D14	V218	C11	V276	F15
R385	D14	V219	C15	V277	F15
R386	E14	V220	C12	V278	F15
R387	E14	V221	C14	V279	F16
R388	D15/E15	V222	C16	V281	F16
R389	E14/E15	V223	C16	V282	F11
R390	E14	V224	C16	V283	F11
R391	E14	V225	B14	V284	F12
R392	E14/D14	V226	D14	V285	C11
R393	E14	V227	C15	V286	F13
R394	E15/E14	V228	C15/C16	V287	F14
R395	E14	V229	C16	V288	B13/B12
R396	E14	V230	D16 (TS)	V289	A13/A12
R397	E15	V231	D15	V291	D14
R398	B13	V232	D16	V292	E14
R399	B12	V233	D15	V293	E14
R400	B12	V234	D16	V294	D11/D12
R401	B12	V235	D11	V295	D12
R402	B12	V236	D16	V296	B12
R403	B12	V237	D15	V297	B12
		V238	D15/D16	V298	B12
				V299	A12
				V1371	B16
				V1372	A16
				V1373	B15
				V1374	B17

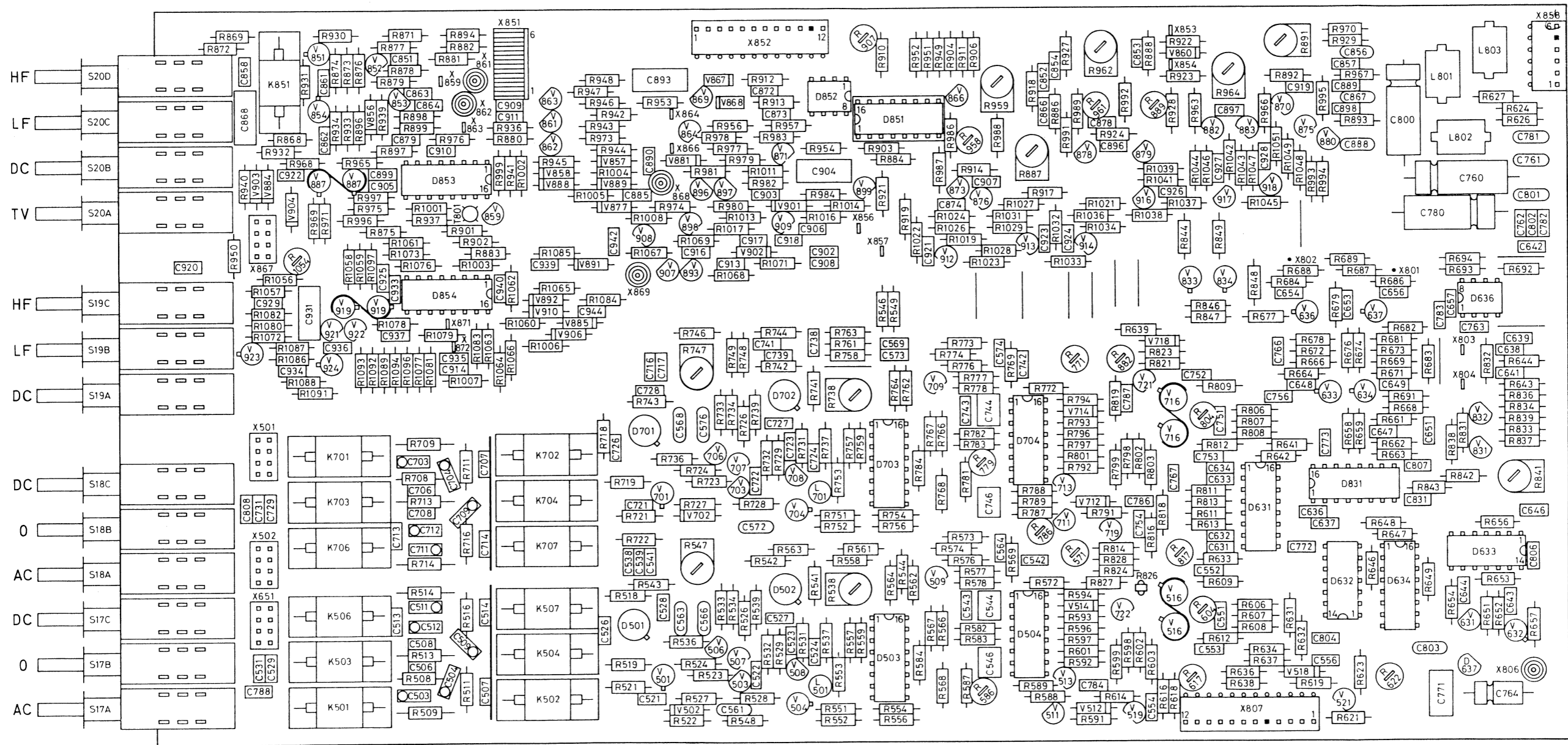
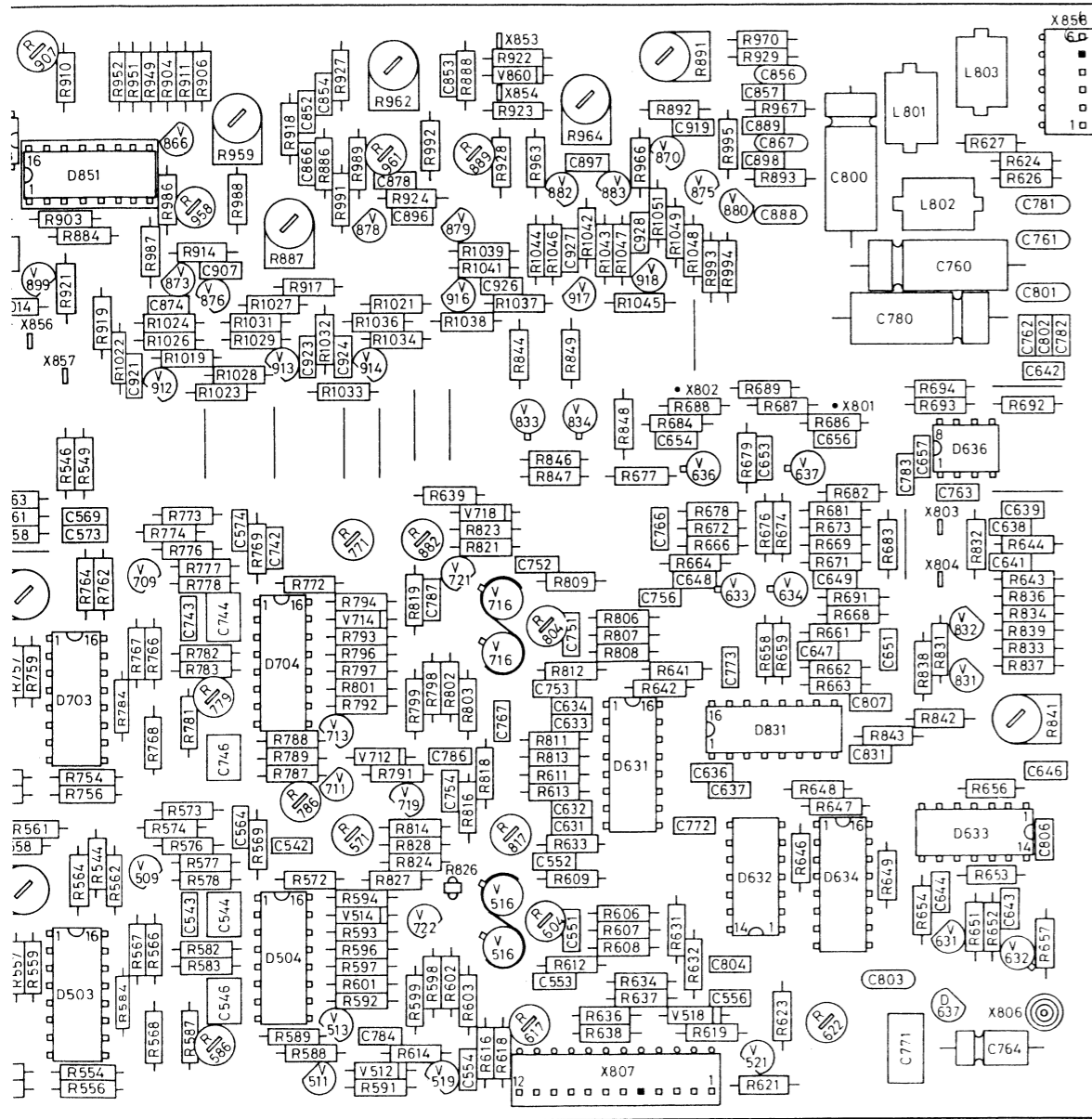

Fig. 7.8. Pre-amplifier and trigger unit p.c.b. with component location raster

7.5. LOCATION LIST OF PARTS SITUATED ON THE PRE-AMPLIFIER AND TRIGGER UNIT 3 (see Fig. 7.8).



MAT 1180

Capacitors				
C501	F1	C573	C6	
C502	F1	C574	C6	
C503	F2			
C504	F3	C576	D4	
C506	F2	C631	E8	
C507	F3	C632	E8	
C508	F2	C633	D8	
C509	F3	C634	D8	
C511	E2	C636	E9	
		C637	E9	
C513	E2	C638	C10	
C514	E3	C639	C10	
			C729	D1
			C731	D1
			C736	D6
			C737	D6
			C738	C5
			C739	C5
			C741	C5
			C742	C7
			C743	D6
			C744	D6
			C746	D6, E6
C521	F4	C641	C10	
C522	F5	C642	B10	
C523	F5	C643	E10	
		C644	E10	
C526	E4, F4	C646	E10	
C527	E5	C647	D9	
C528	E4	C648	D9	
C529	F1	C649	D9	
			C751	D8
			C753	D8
			C754	E7
			C756	D8
			C760	B10
			C761	B10
			C762	B10
			C763	C10
			C764	F10
			C766	C8
			C767	D8
			C768	F6
			C771	F10
			C772	E9
			C773	D9
			C780	B10
			C781	B10
			C782	B10
			C783	C10
			C784	F7
			C786	D7, D8
			C787	D7
			C788	F1
			C800	A9
			C801	B10
			C802	B10
			C803	F10
			C804	F9
			C806	E10
			C807	D9
			C808	D1
C531	F1	C651	D10	
C536	F6	C653	C9	
C537	E6	C654	C8, C9	
C538	E4			
C539	E4	C656	C9	
		C657	C10	
C541	E4			
C542	E7	C702	E1	
C543	E6	C703	D2	
C544	E6	C704	D3	
			C706	D2
			C707	D3
			C708	E2
			C709	E3
			C711	E2
			C712	E2
			C713	E2
			C714	E3
			C716	C4
			C717	C4
			C721	D4
			C722	D5
			C723	D5
			C726	D4
			C727	D5
			C728	D4
C556	F9			
C561	F5			
C563	E4			
C564	E6			
C566	E4			
C568	D4			
C569	C6			
C572	E5			

C831	D9	C921	B6, C6	R513	F2
C851	A2	C922	B1	R514	E2
C851	A2	C923	B7	R516	E3
C852	A7	C924	B7	R517	E4, F4
C853	A7	C925	C2	R518	E4
C854	A7	C926	B8	R519	F4
C856	A9	C927	B8	R521	F4
C857	A9	C928	B8	R522	F4
C858	A1	C929	C1	R523	F4
C861	A2	C930	C2	R524	F4
C862	A2	C931	C1, C2	R526	E5
C863	A2	C932	C2	R527	F4
C864	A2	C933	C2	R528	F5
C866	A7	C934	C1	R529	F5
C867	A9	C935	C3	R531	F5
C868	A1	C936	C2	R532	F5
C869	B3	C938	C2	R533	E5
C870	B2	C939	C3	R534	E5
C872	A5	C940	C3	R536	E4
C873	A5	C942	B4	R537	F5
C874	B6	C944	C3, C4	R538	E6, E5
C878	A7	C945	C3	R539	E5
C879	A2			R541	E5
C881	A1		Integrated circuit	R543	E4
C884	B3	D501	E4, F4	R544	E6
C885	B4	D502	E5	R546	C6
C888	B9	D503	F6	R547	E4
C889	A9	D504	E7, F7	R548	F5
C890	B4	D631	D8, E8	R549	C6
C893	A4	D632	E9	R551	F5
C896	B7	D633	E10	R552	F5
C897	A8	D634	E9	F553	F5
C898	A9	D636	C10	R554	F6
C899	B2	D701	D4	R555	F6
C900	B2	D702	D5	R556	F6
C902	B5, C5	D703	D6	F557	F5
C903	B5	D704	D7	R558	E5, F6
C904	B5	D831	D9	R559	F6
C905	B2	D851	A6	R560	E6
C906	B5	D852	A5	R561	E6
C907	B6	D853	B2, B3	R562	E6
C908	C5	D854	C2, C3	R564	E6
C909	A3			R566	F6
C910	B2, B3		Resistors	R567	F6
C911	A3	R501	F1	R569	E7
C913	C5	R502	F1	R571	E7
C914	C3	R503	F1	R572	E7
C915	A3	R504	F1	R573	E6
C916	B4, C4	R506	F1	R574	E6
C917	B5	R508	F2	R576	E6
C918	B5	R509	F2	R577	E6
C919	A8, A9	R511	F3	R578	E6
C920	C1	R512	F4		

R582	F6	R651	E10	R722	E4
R583	F6	R652	E10	R723	D4
R584	F6	R653	E10	R724	D4
R586	F6	R654	E10	R726	D5
R587	F6	R656	E10	R727	D4
R588	F7	R657	F10	R729	D5
R589	F7	R658	D9	R732	D5
R591	F7	R659	D9	R733	D5
R592	F7	R660	D9	R734	D5
R593	E7	R661	D9	R736	D4
R594	E7	R662	D9	R737	D5
R596	F7	R663	D9	R738	D5
R597	F7	R664	C9	R739	D5
R598	F7	R666	C9	R741	D5
R599	F7	R668	D9	R742	C5
R601	F7	R669	C9	R743	D4
R602	F7	R671	C9	R744	C5
R603	F8	R672	C9	R746	C4
R604	E8	R673	C9	R747	C4
R606	E8	R674	C9	R748	C5
R607	E8	R676	C9	R749	C5
R608	E8	R678	C9	R751	E5
R609	E8	R679	C9	R752	E5
R611	E8	R681	C9	R753	D5
R612	F8	R682	C9	R754	E6
R613	E8	R683	C10	R755	D6
R614	F7	R684	C8	R756	E6
R616	F8	R686	C9	R757	D5
R617	F8	R687	C9	R758	C5
R618	F8	R688	C9	R759	D6
R619	F9	R689	C9	R760	D6
R621	F9	R691	D9	R761	C5
R622	F9	R692	C10	R762	D6
R623	F9	R693	C10	R763	C5
R624	A10	R694	C10	R764	D6
R626	A10	R701	E1	R766	D6
R627	A10	R702	E1	R767	D6
R632	F9	R703	E1	R768	D6
R633	E8	R704	E1	R769	C7
R634	F8	R706	D1	R771	C7
R636	F8	R708	D2	R773	C6
R637	F8	R709	D2	R774	C6
R638	F8	R711	D3	R776	C6
R639	C7	R712	D4	R777	C6, D6
R641	D8	R713	D2	R778	D6
R642	D8	R714	E2	R779	D6
R643	D10	R716	E3	R781	D6
R644	C10	R717	E4	R782	D6
R646	E9	R718	D4	R783	D6
R647	E9	R719	D4	R784	D6
R648	E9			R786	E7
R649	E10			R787	E7
				R788	D7
				R789	D7

R791	E7	R878	A2	R953	A4
R792	D7	R879	A2	R954	B5
R793	D7	R880,	A3, B3	R955	A3
R794	D7	R881	A3	R956	A5
R796	D7	R882	A3	R957	A5
R797	D7	R883	B3	R958	B6
R798	D7	R884	B6	R959	A6
R799	D7	R886	A7	R960	A3
R801	D7	R887	B7	R961	A7
R802	D7	R888	A7, A8	R962	A7
R803	D8	R889	A7, A8	R963	A8
R804	D8	R891	A8, A9	R964	A8
R806	D8	R893	A9	R965	B2
R807	D8	R894	A3	R966	A8
R808	D8	R896	A2	R967	A9
R809	D8	R898	A2	R968	B1
R811	D8	R899	A2	R969	B2
R812	D8	R901	B3	R970	A9
R813	D8	R902	B3	R971	B2
R814	E7	R903	B6	R972	B3, B4
R816	E8	R912	A5	R973	A4
R817	E8	R913	A5	R974	B4
R818	E8	R914	B6	R975	B2
R819	D7	R917	B7	R976	A3
R821	C8	R918	A7	R977	B5
R823	C8	R919	B6	R979	B5
R824	E7	R921	B6	R980	B5
R826	E7	R922	A8	R982	B5
R827	E7	R923	A8	R984	B5
R828	E7	R927	A7	R986	A6, B6
R831	D10	R928	A8	R987	B6
R832	C10	R929	A9	R988	B6
R833	D10	R930	A2	R991	A7
R834	D10	R931	A2	R992	A7
R836	D10	R932	B1	R993	B9
R837	D10	R933	A2	R994	B9
R838	D10	R934	A2	R995	A9
R839	D10	R936	A3	R996	B2
R841	D10	R937	B2	R997	B2
R842	D10	R938	A1	R998	C2
R843	D10	R939	A2	R999	B3
R844	B8	R940	B1	R1000	B3
R846	C8	R941	B3	R1001	B2
R847	C8	R942	A4	R1002	B3
R848	C8	R943	A4	R1004	B4
R849	B8	R944	B4	R1005	B4
R868	A1	R945	B3	R1006	C3
R869	A1	R946	A4	R1007	C3
R871	A2	R947	A3, A4	R1008	B4
R872	A1	R948	A4	R1011	B5
R873	A2			R1013	B5
R874	A2			R1014	B5
R875	B2			R1016	B5
R876	A2			R1017	B5
R877	A2			R1019	B6

R1021	B7	R1092	C2	V636	C9
R1022	B6	R1093	C2	V637	C9
R1023	C6	R1094	C2	V701	D4
R1024	B6	R1095	B7	V702	E4
R1026	B6	R1096	C2	V703	D5
R1027	B7	R1097	C2	V706	D4, D5
R1028	B6, C6	R1098	B7	V707	D5
R1029	B7	R1099	B8	V708	D5
R1031	B7			V709	D6
R1032	B7	Reed Relays		V711	E7
R1033	C7	K501	F2	V712	D7
R1034	B7	K502	F3	V713	D7
R1036	B7	K503	F2	V714	D7
R1037	B8	K504	F3	V716	D8
R1038	B8	K506	E2	V718	C8
R1039	B8	K507	E3	V719	E7
R1041	B8	K701	D2	V721	D8
R1042	B8	K702	D3	V722	E7
R1043	B8	K703	D2	V831	D10
R1044	B8	K704	D3	V832	D10
R1045	B8	K706	E2	V833	C8
R1046	B8	K707	E3	V834	C8
R1047	B8	K851	A1, A2	V851	A2
R1048	B9			V852	A2
R1049	B8	Coils		V853	A2
R1051	B8	L701	D5	V854	A2
R1056	C1	L801	A10	V856	A2
R1057	C1	L802	B10	V857	B4
R1058	C2	L803	A10	V858	B3
R1059	C2			V860	A8
R1060	C3	Transformer		V861	A3
R1061	B2	T801	B3	V862	B3
R1062	C3			V863	A3
R1063	C3	Semiconductors		V864	A4
R1064	C3	V501	F4	V865	B7
R1065	C3	V502	F4	V867	A4, A5
R1066	C3	V503	F5	V868	A5
R1067	B4	V504	F5	V869	A4
R1068	C5	V506	F5	V870	A8
R1069	B4	V507	F5	V871	B5
R1071	C5	V508	F5	V872	B6
R1072	C1	V509	E6	V873	B6
R1073	B2	V511	F7	V874	B7
R1076	C2	V512	F7	V875	A8
R1077	C2	F513	F7	V876	B6
R1079	C2	V514	E7	V877	B4
R1080	C1	V516	E8, F8	V878	B7
R1081	C2	V518	F9	V879	B7, B8
R1082	C1	V519	F7	V880	B9
R1083	C3	V521	F9	V881	B4
R1084	C4	V631	E10	V882	A8
R1085	B3	V632	F10	V883	A8
R1086	C1	V633	D9	V884	B1
R1087	C1	V634	D9	V885	C3
R1088	C1				
R1089	C2				
R1090	B6				

V887	B2
V888	B3
V889	B4
V890	C3
V891	C3
V892	C3
V893	C4
V895	B8
V896	B4
V897	B5
V898	B4
V899	B6
V901	B5
V902	B5
V903	B1
V904	B1
V907	C4
V908	B4
V909	B5
V910	C3
V912	C6
V913	B7
V914	B7
V916	B8
V917	B8
V918	B8
V919	C2
V921	C2
V922	C2
V923	C1
V924	C2

8. DIAGRAMS AND PRINT LAY-OUTS

8.1. LOCATION OF ELECTRICAL PARTS

Item numbers of C ..., R ..., V ... and K ... have been divided in groups which relate to the circuit, the unit and the circuit diagram, according the following table.

Itemnumber	Location	Unit	Figure
1 ... 99	Potentiometer unit, front and rear side	103	8.17.
100 ... 199	Switch unit	102	8.16.
200 ... 499 } 1370 ... 1399 }	Time base unit	2	8.8./8.10.
500 ... 1099	Preamplifier and trigger unit	3	8.1./8.3.
1100 ... 1199	Trigger selection unit	4	8.7.
1200 ... 1299	Final Y amplifier	9	8.2.
1300 ... 1369 }	Final X/Z amplifier	5	8.12.
1500 ... 1599 }			
1400 ... 1499	Power supply	6	8.14

NOTE: The components on the time base unit (unit 2) and the preamplifier and trigger unit (unit 3) can be found with the location lists in chapter 7.4. and 7.5.

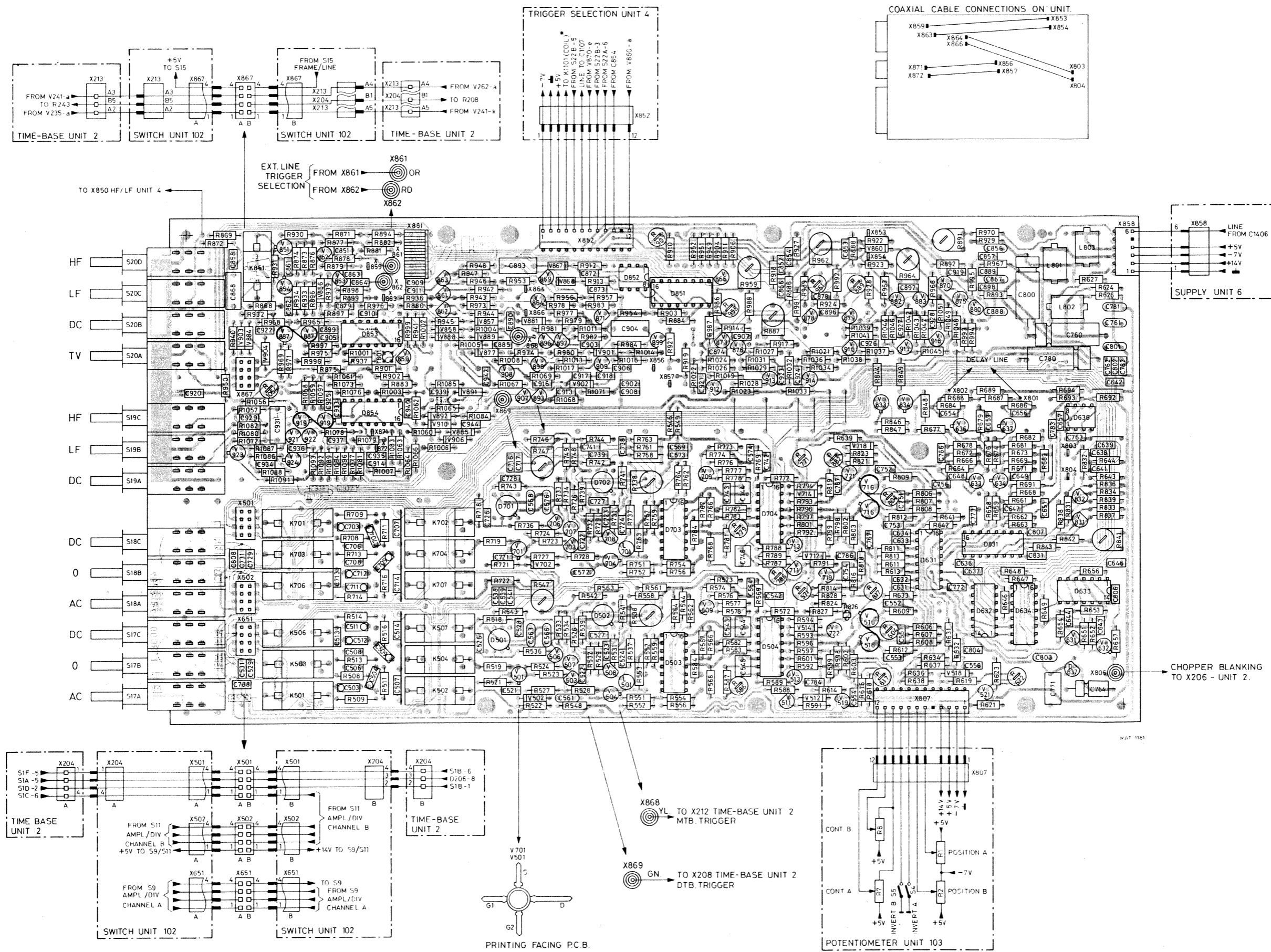

Fig. 8.1. Pre-amplifier and trigger-unit (unit 3), p.c.b. layout

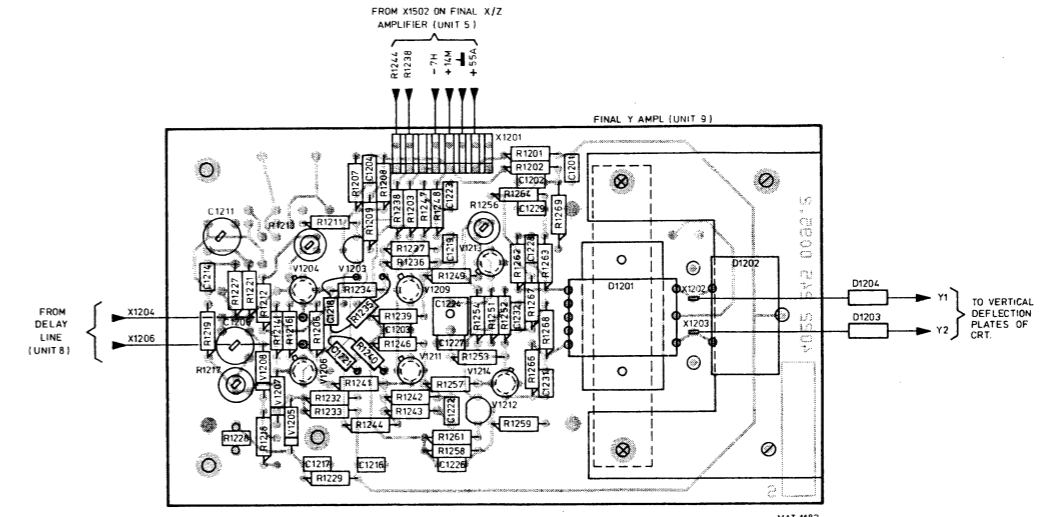
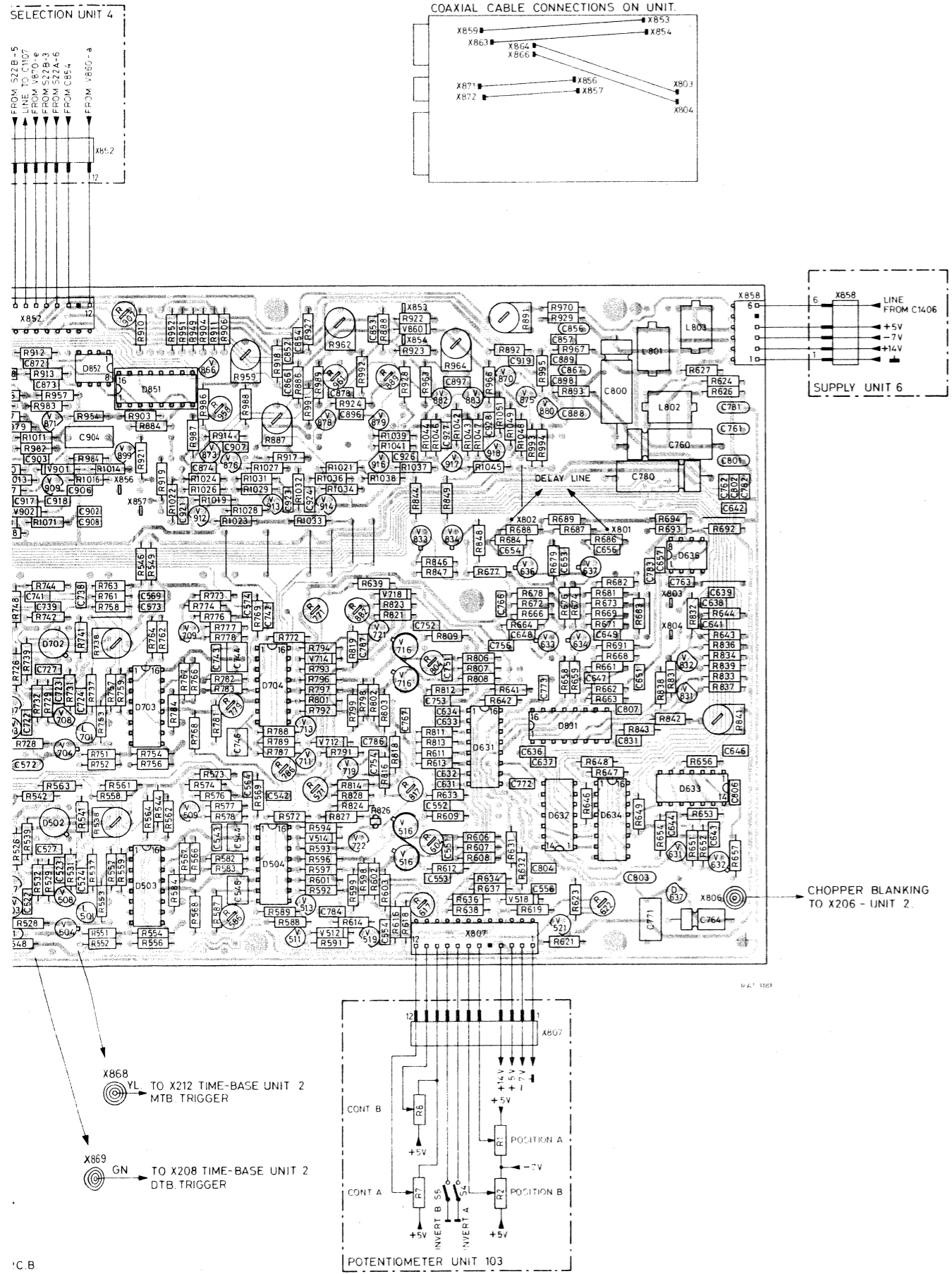

Fig. 8.2. Final Y-amplifier (unit 9), p.c.b. lay-out

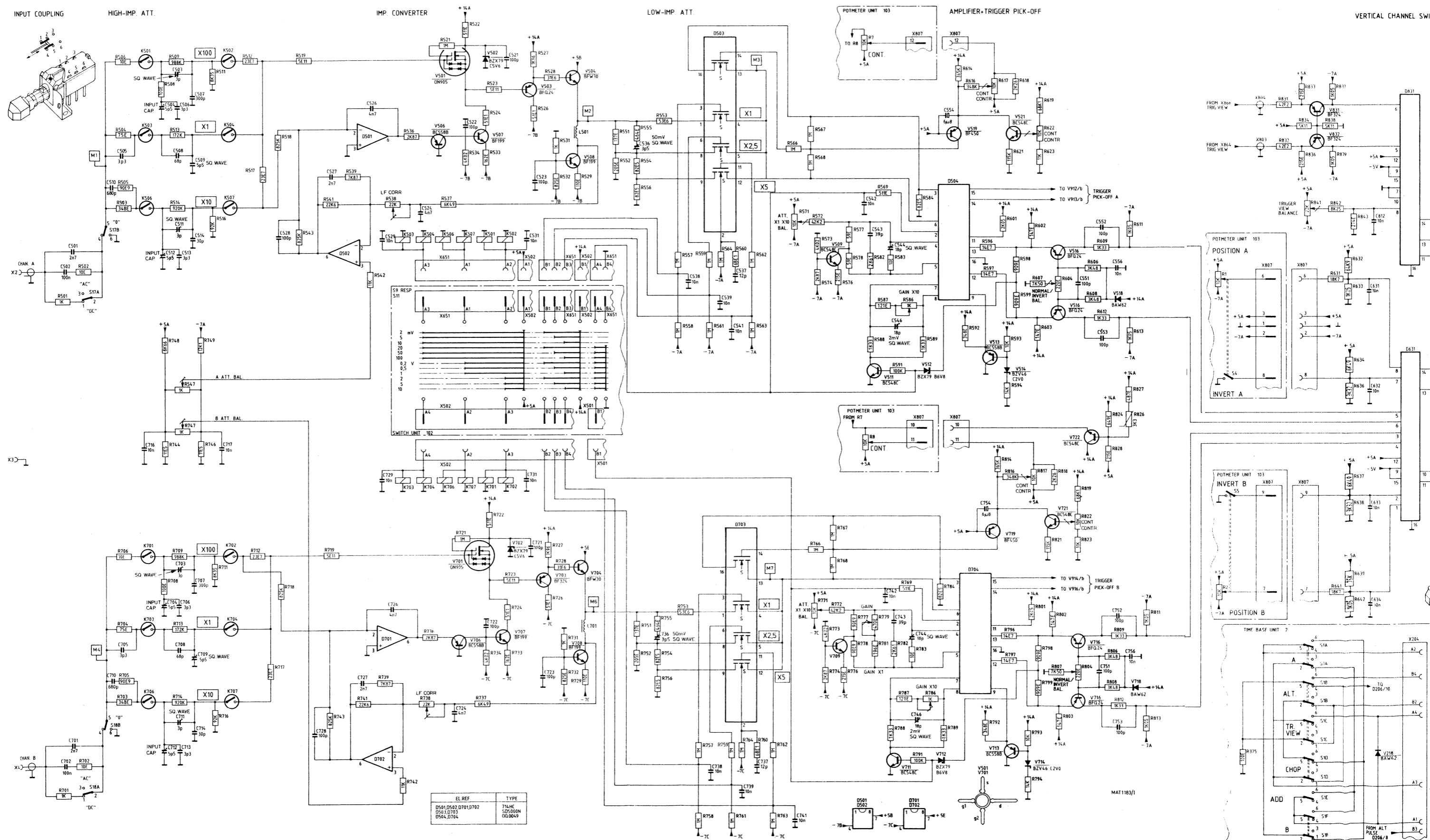
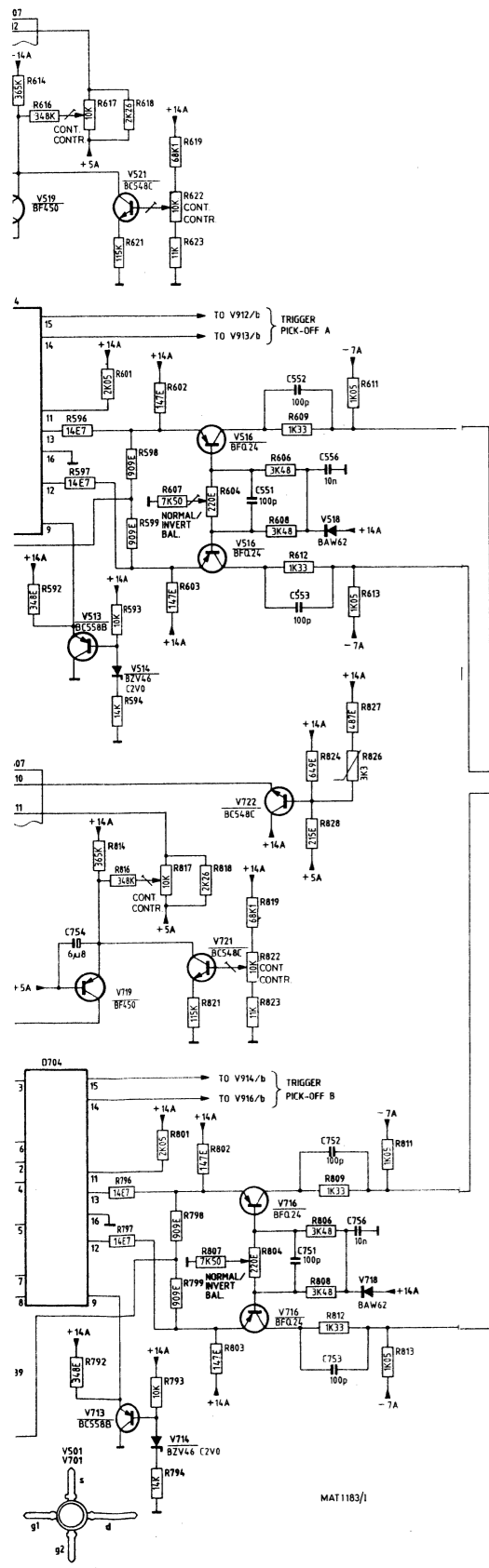

Fig. 8.3. Circuit diagram vertical deflection (attenuator, channel switch, final Y-amplifier)

EL REF	TYPE
DS01, DS02, D701, D702	714HC
DS03, D703	SOS000M
DS04, D704	00.0049

AMPLIFIER+TRIGGER PICK-OFF



VERTICAL CHANNEL SWITCH

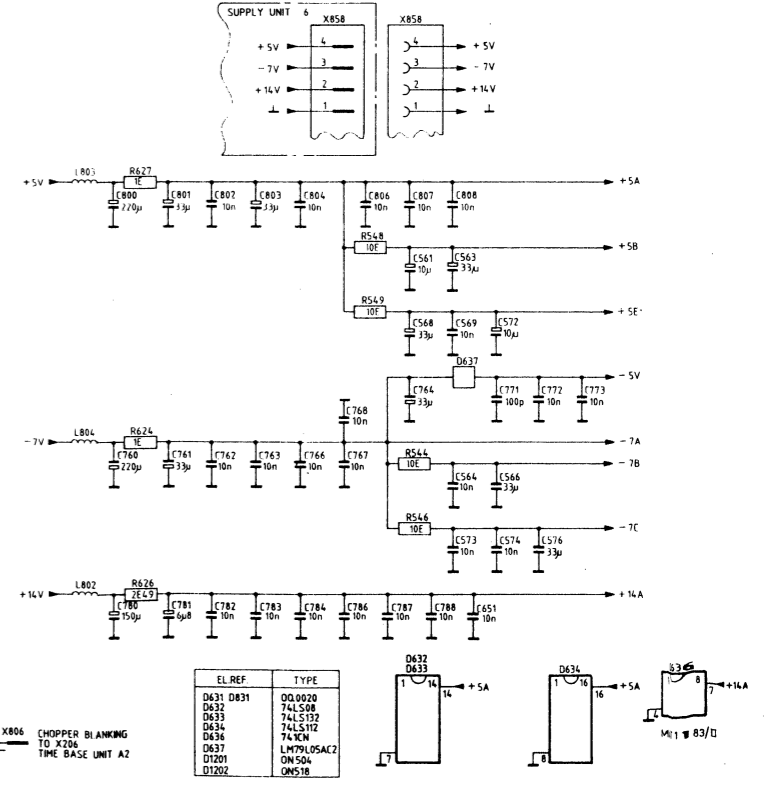
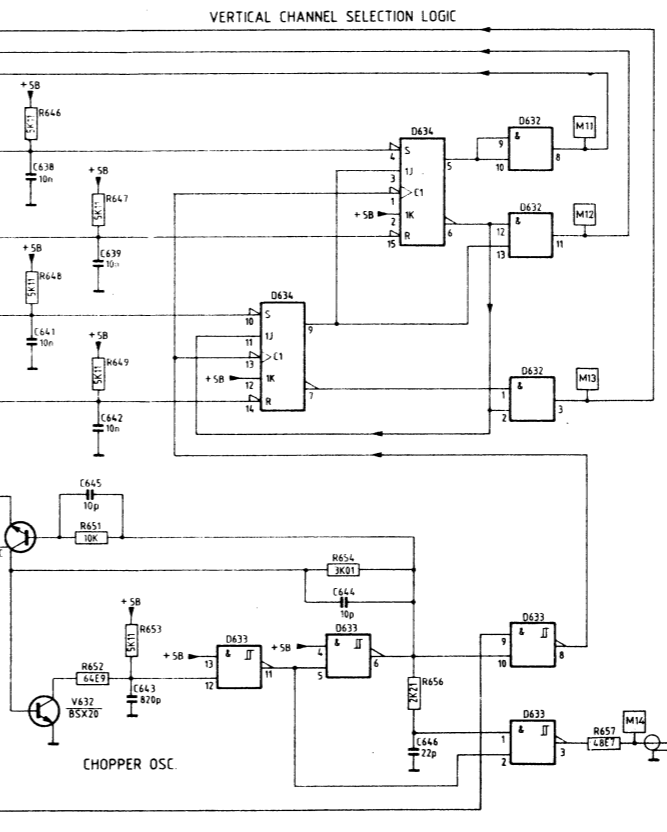
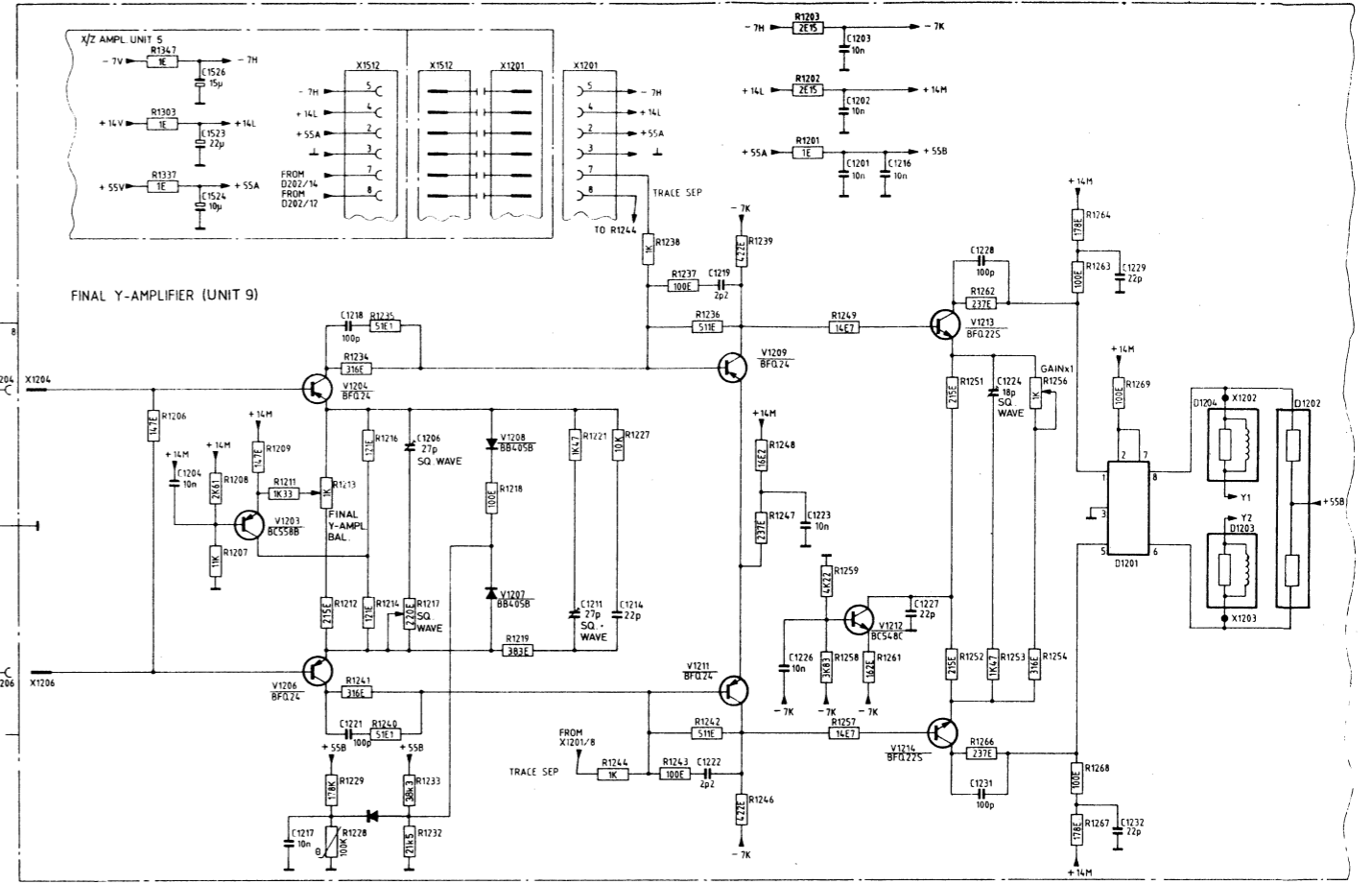
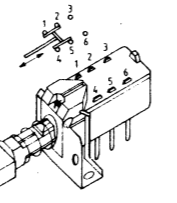
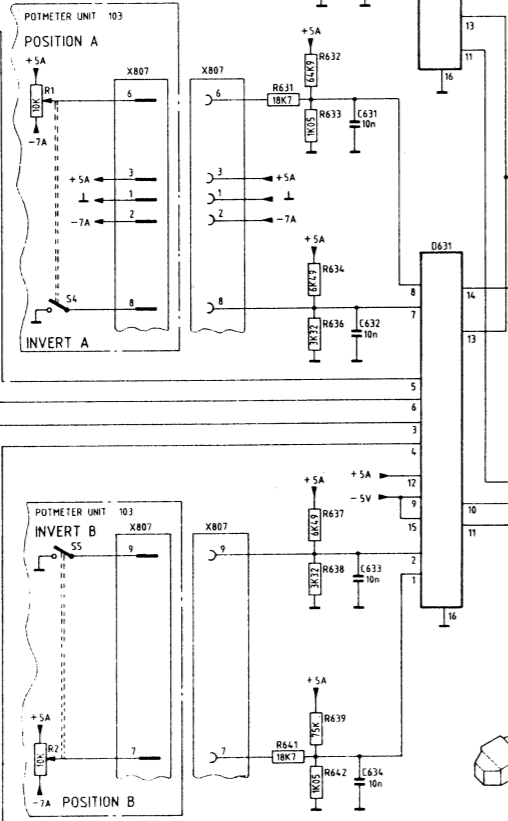
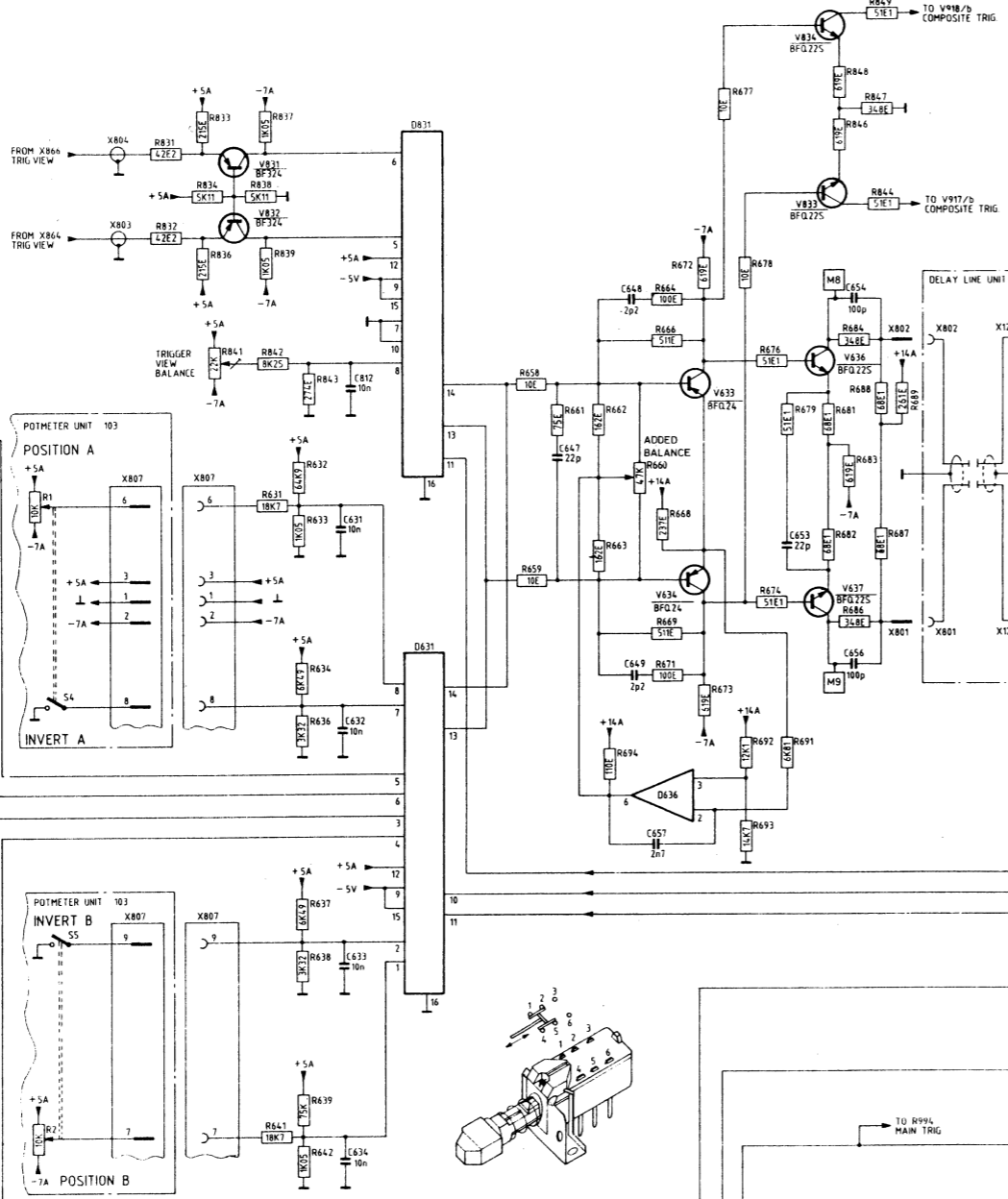

EL REF	TYPE
D631 D831	00.0020
D632 D832	74LS58
D633 D833	74LS132
D634 D834	74LS172
D635 D835	74LS174
D636 D836	74LS175
D637 D837	LM7910SAK2
D1201 D1202	0N50A
D1203 D1204	0N51B

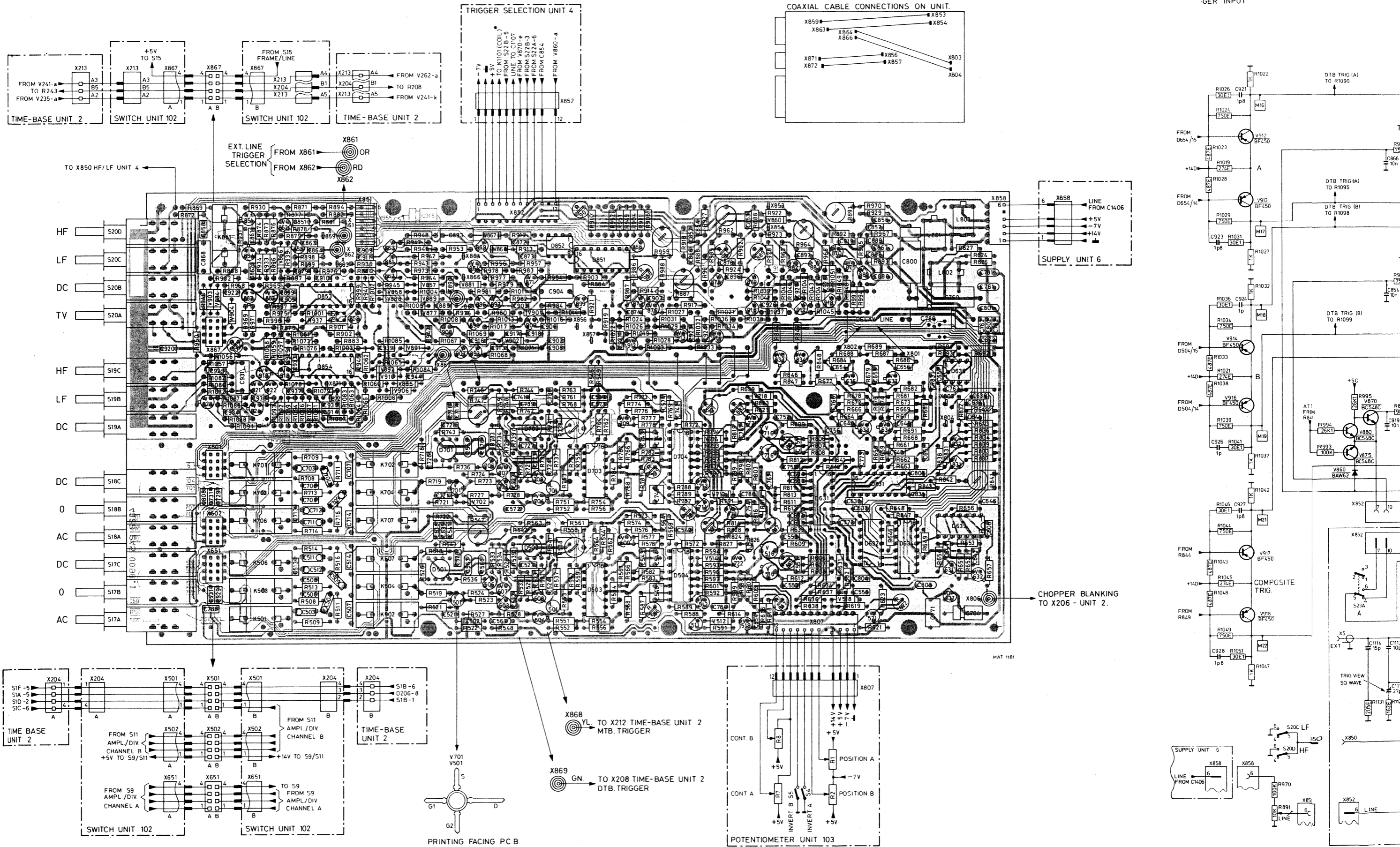

Fig. 8.4. Pre-amplifier and trigger-unit (unit 3), p.c.b. lay-out

GER INPUT

TRIGGER SELECTION

INPUT STAGE

TV	S20A	ECL OPTION
STANDARD	TTL	CLOSED
OPEN	CLOSED	CLOSED
R908	S1K1	S1K1
R909		
V894	BAW62	

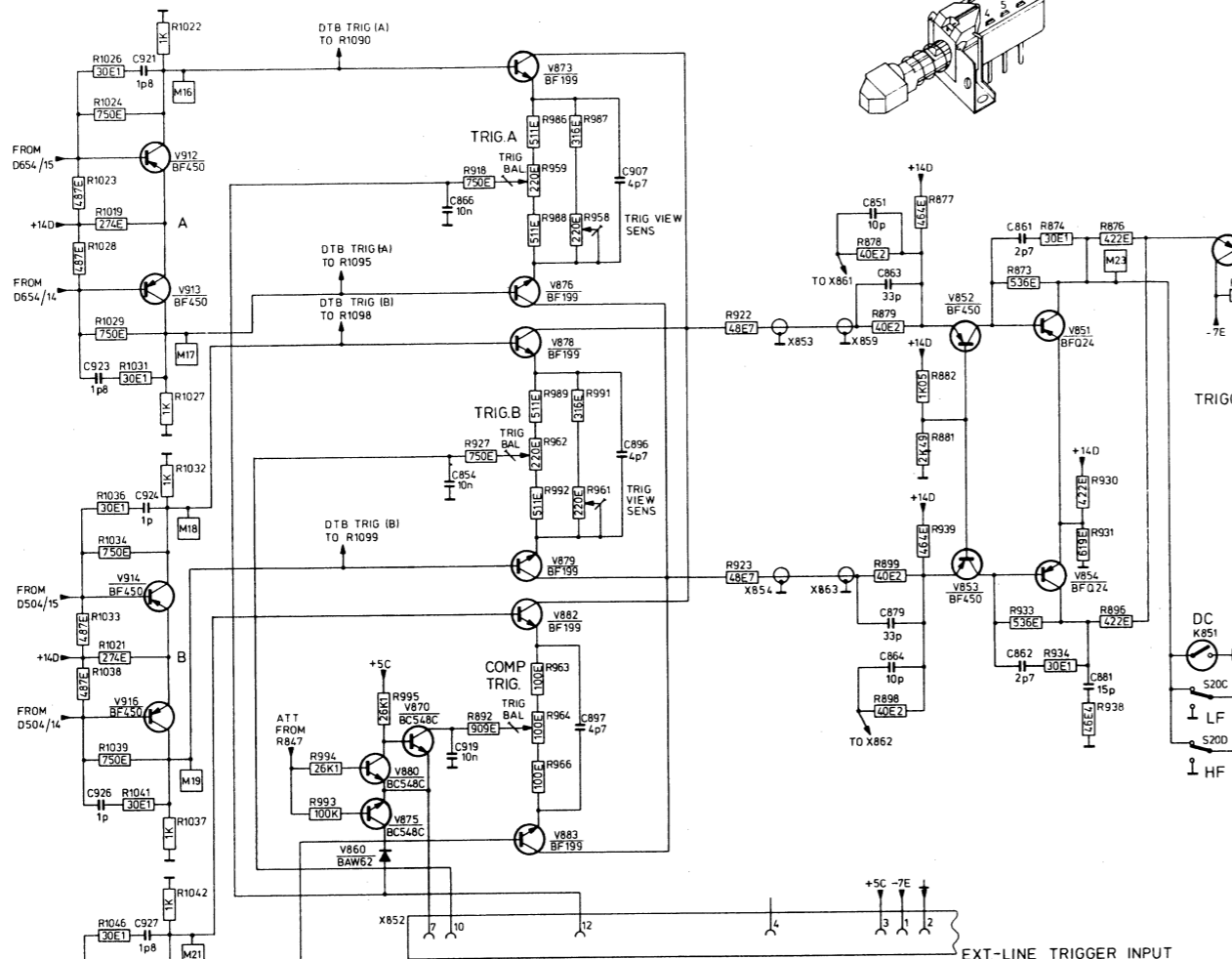
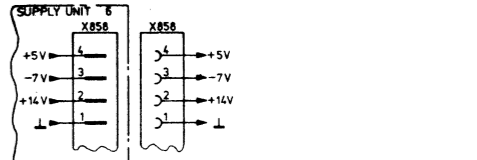
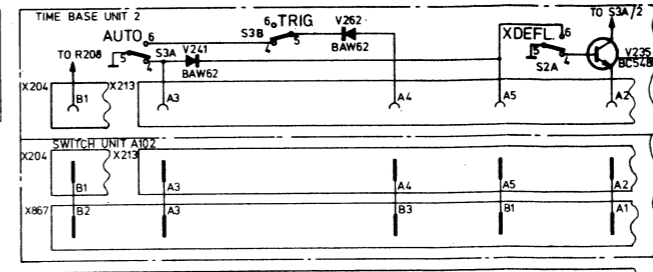

TRIGGER COUPLING

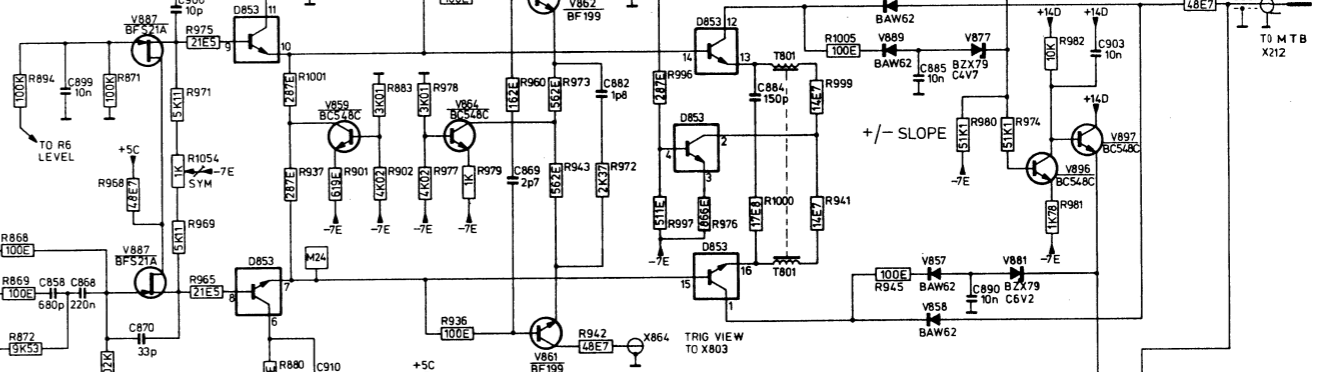

EXT-LINE TRIGGER INPUT

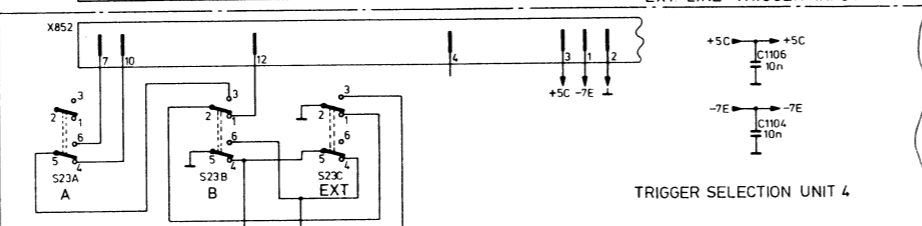

TRIGGER SELECTION UNIT 4

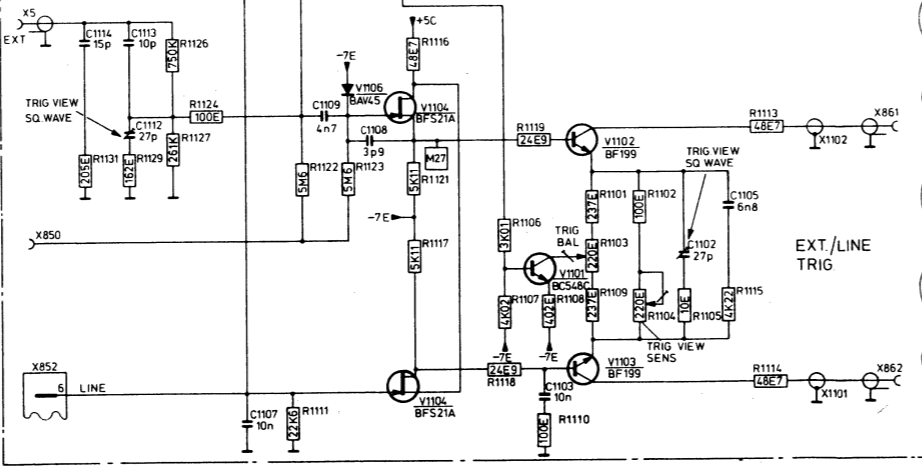

EXT/LINE TRIG

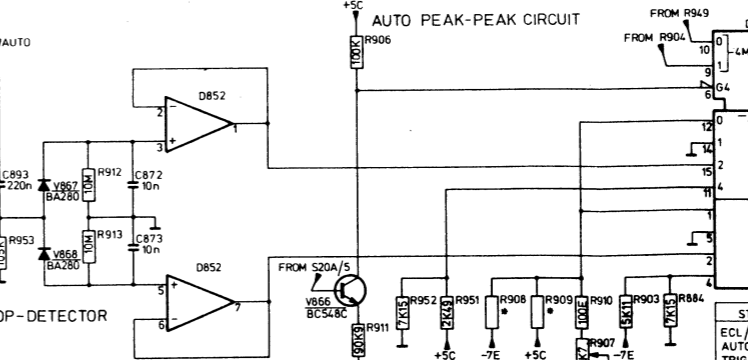

STATUS	0	1	PIN NR
ECL/TTL/TV	0	0	12 / 1
AUTO	1	0	15 / 2
TRIG	1	1	11 / 4
XODEFL	d	d	TRI / STATE

EL REF	TYPE
D851	HEF4052
D852	TL082CP
D853	Q000127

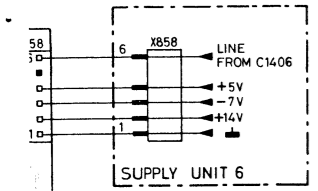

CHOPPER BLANKING TO X206 - UNIT 2.

AT 1181

MAT 1184

Fig. 8.5. Circuit diagram main time-base triggering (unit 3)

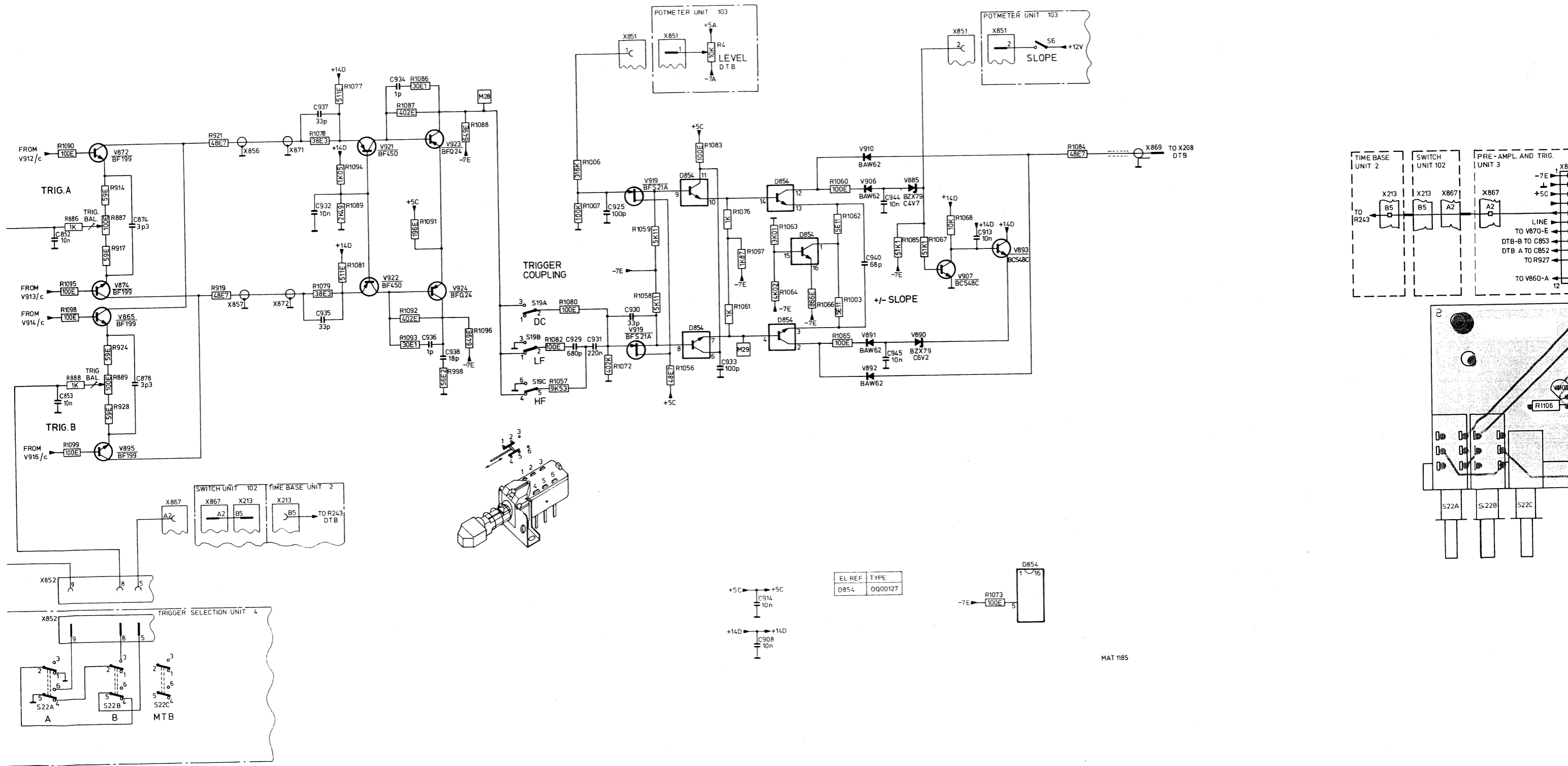

Fig. 8.6. Circuit diagram delayed time-base triggering (unit 3)

Fig. 8.7. Trigger selection unit (unit 4), 1

+12V

R1084
X867 TO X208
DTB

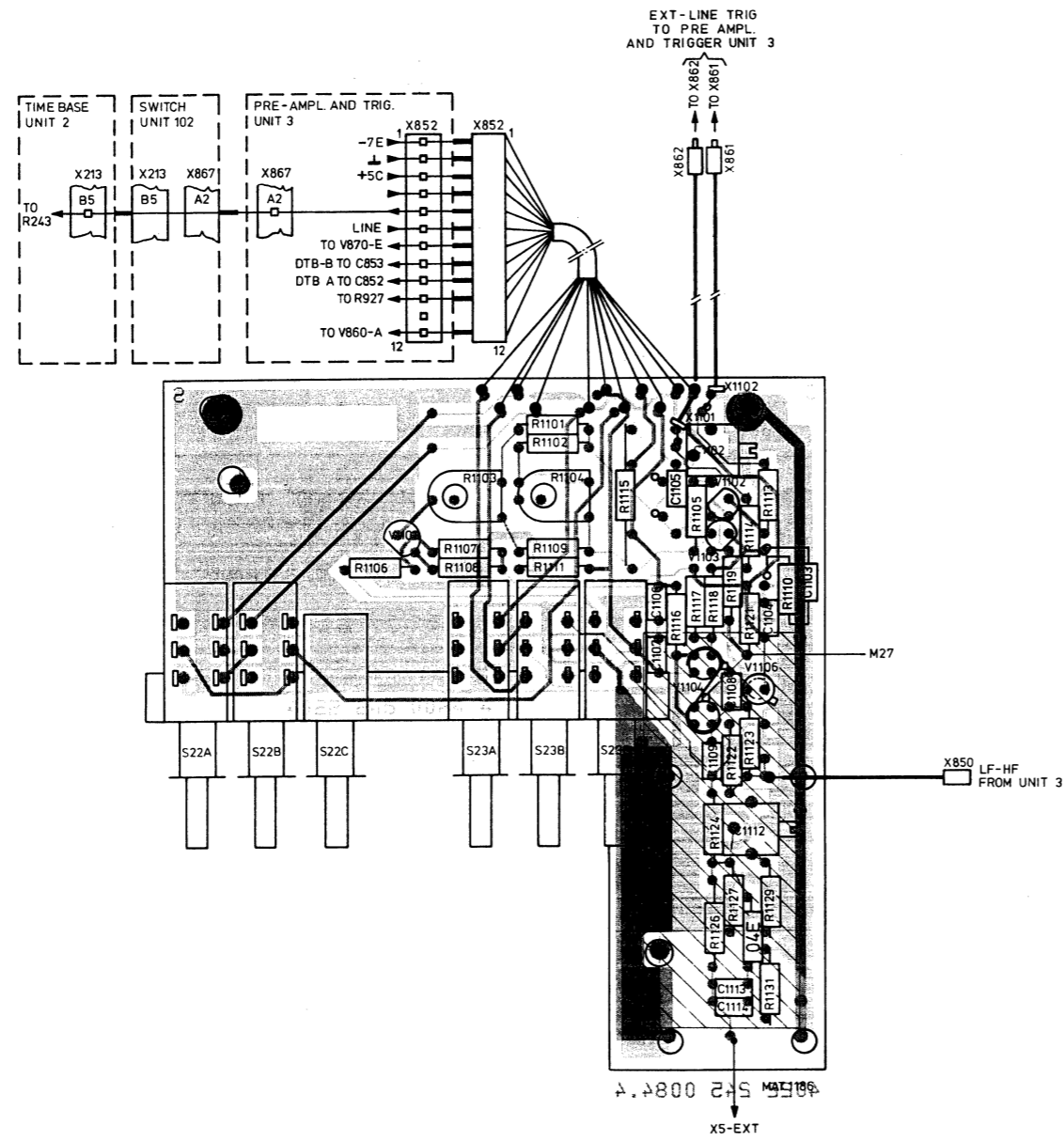

Fig. 8.7. Trigger selection unit (unit 4), p.c.b. lay-out

MAT 1185

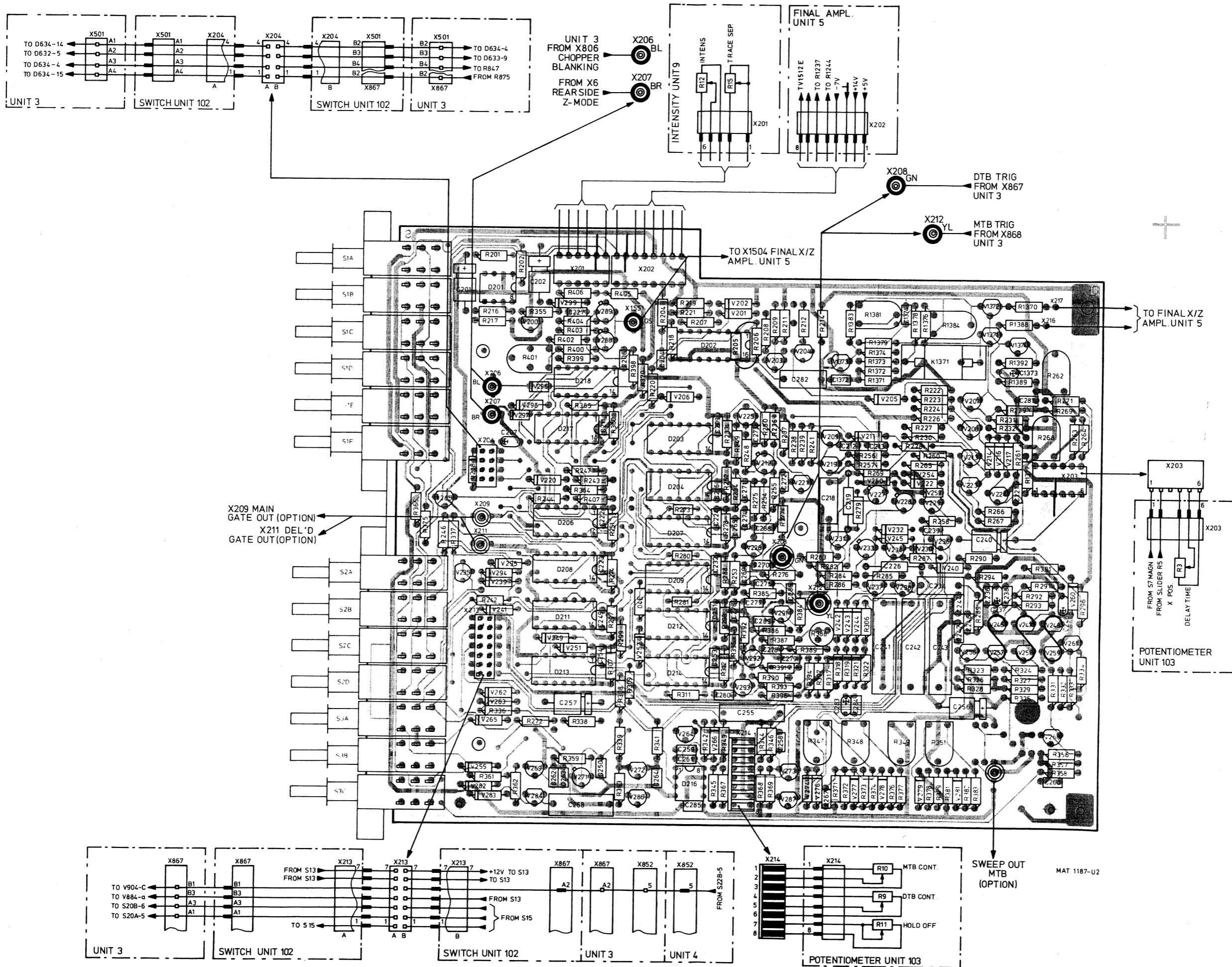

Fig. 8.8. Time-base unit (unit 2), p.c.b. lay-out

Fig. 8.9. Circuit diagram main time-bas

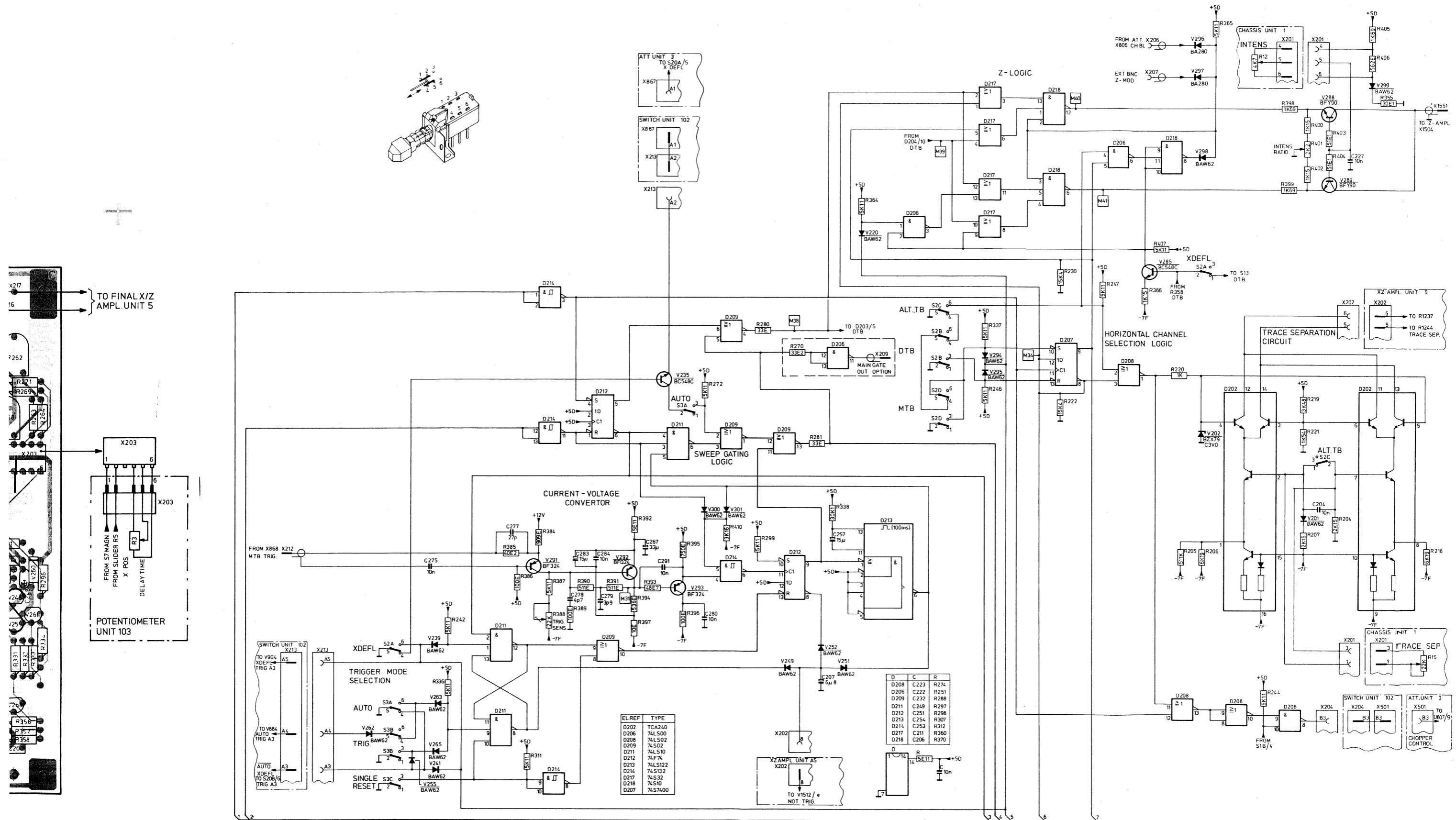
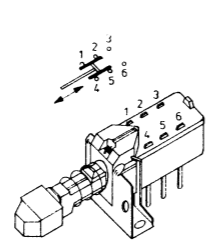

Fig. 8.9. Circuit diagram main time-base (unit 2)

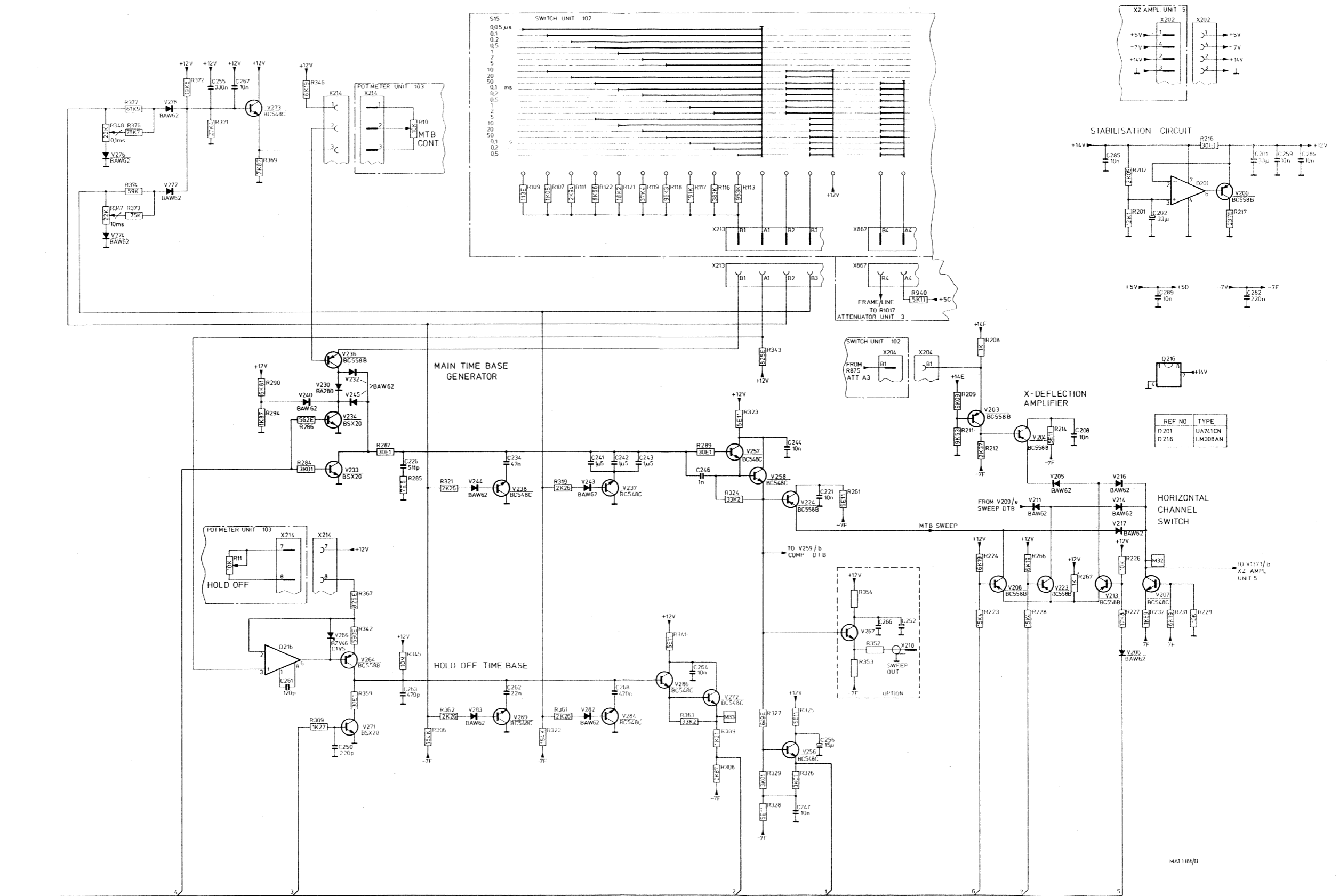

Fig. 8.9. Circuit diagram main time-base (unit 2)

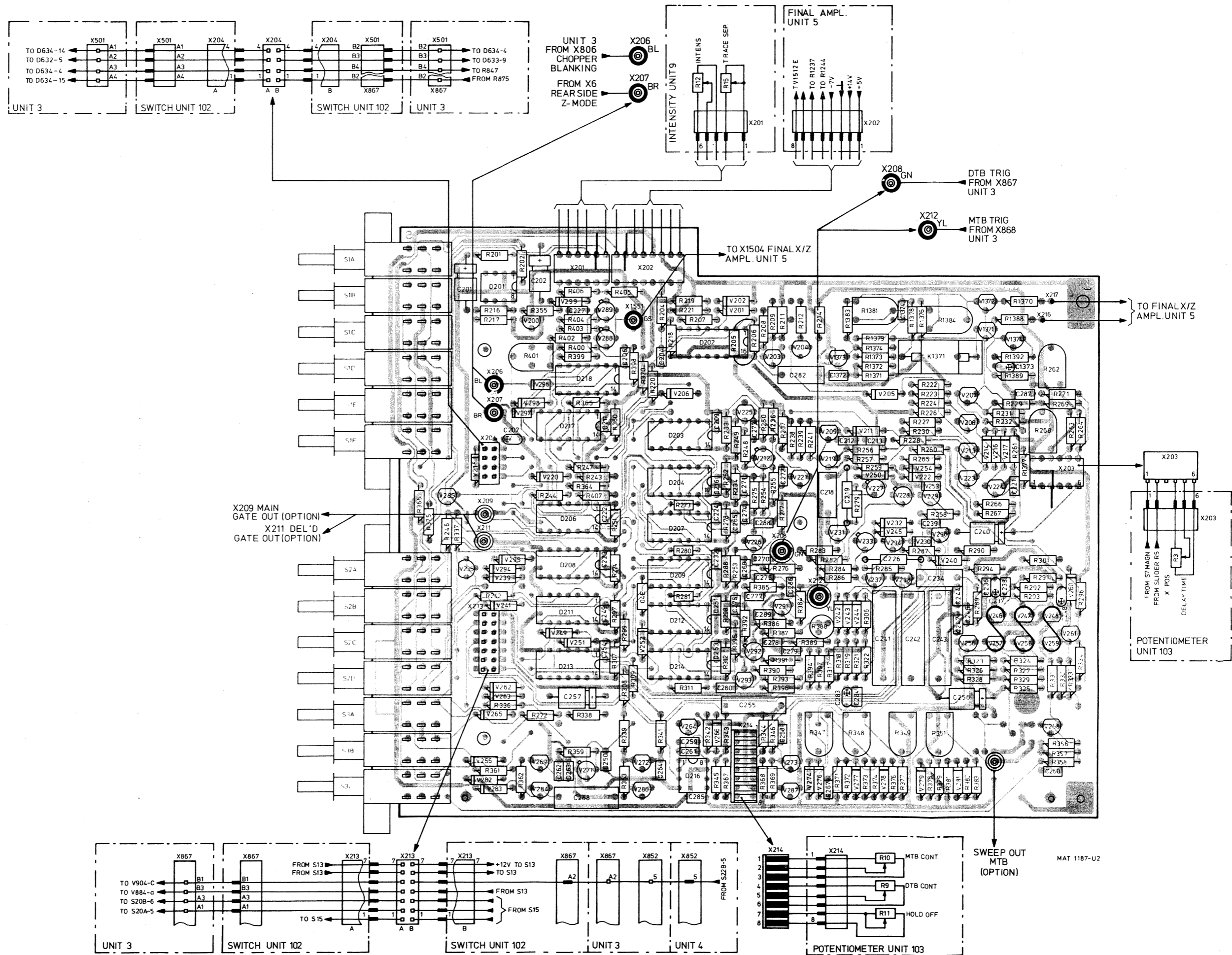

Fig. 8.10. Time-base unit (unit 2), p.c.b. lay-out

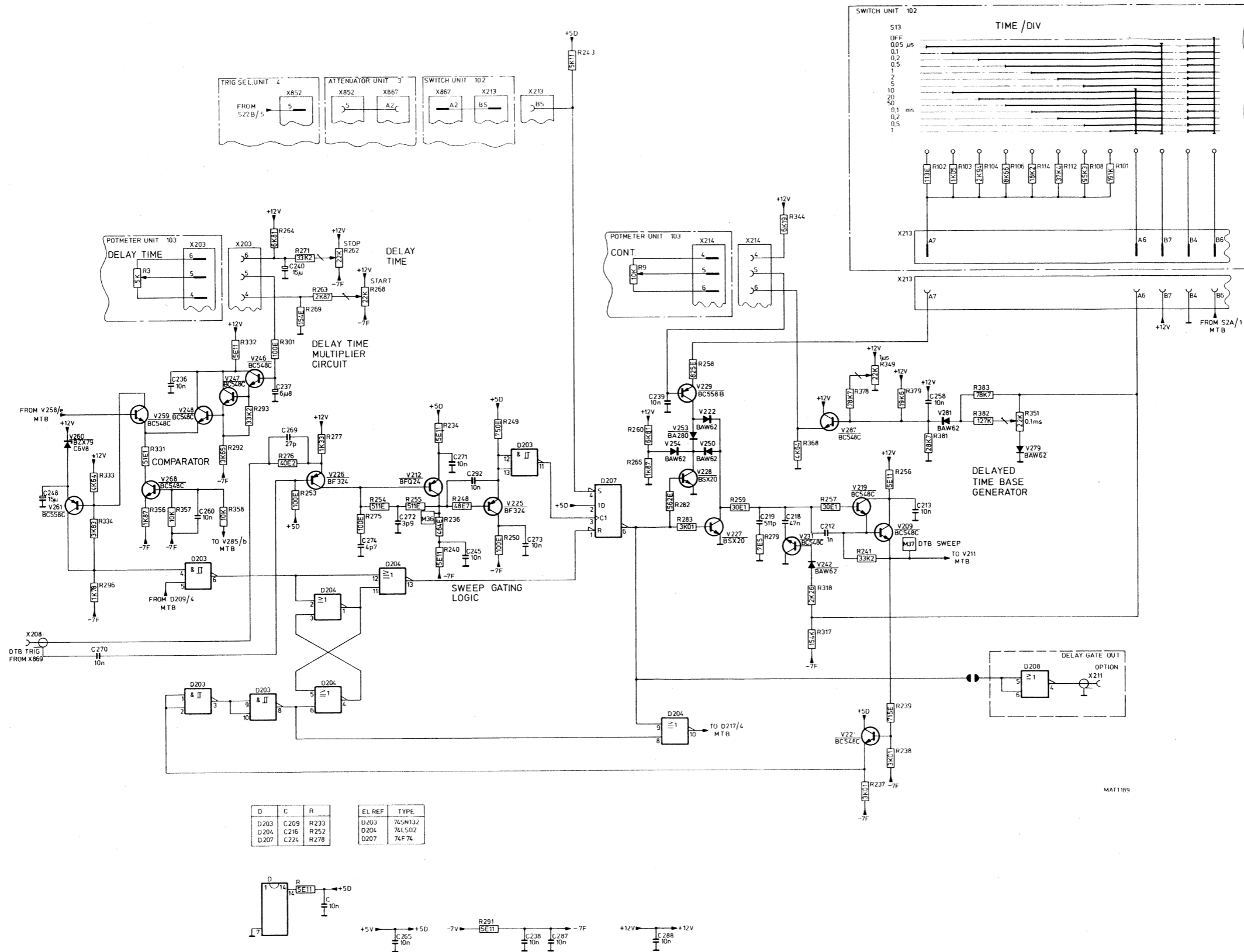
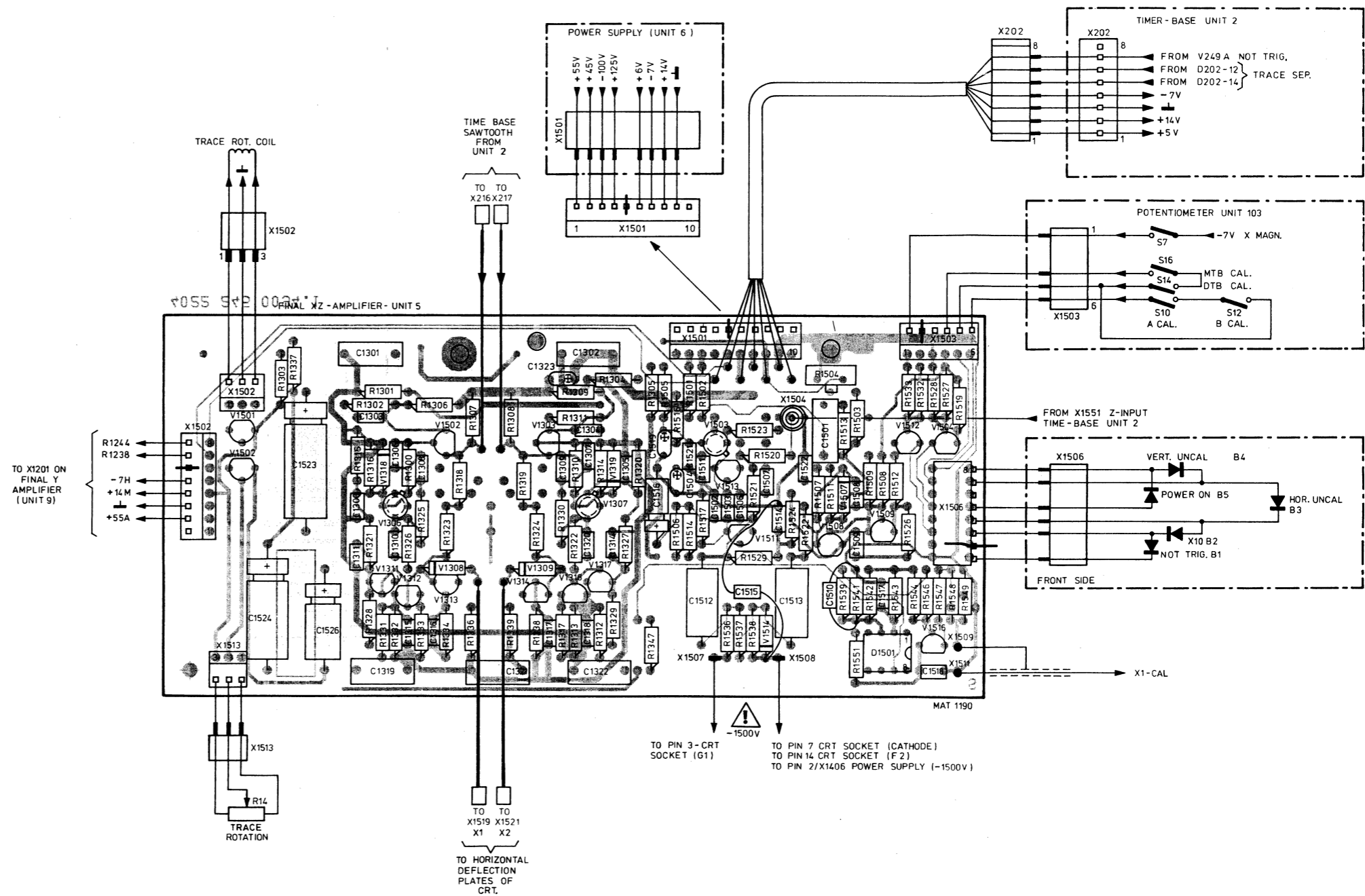

Fig. 8.11. Circuit diagram delayed time-base (unit 2)



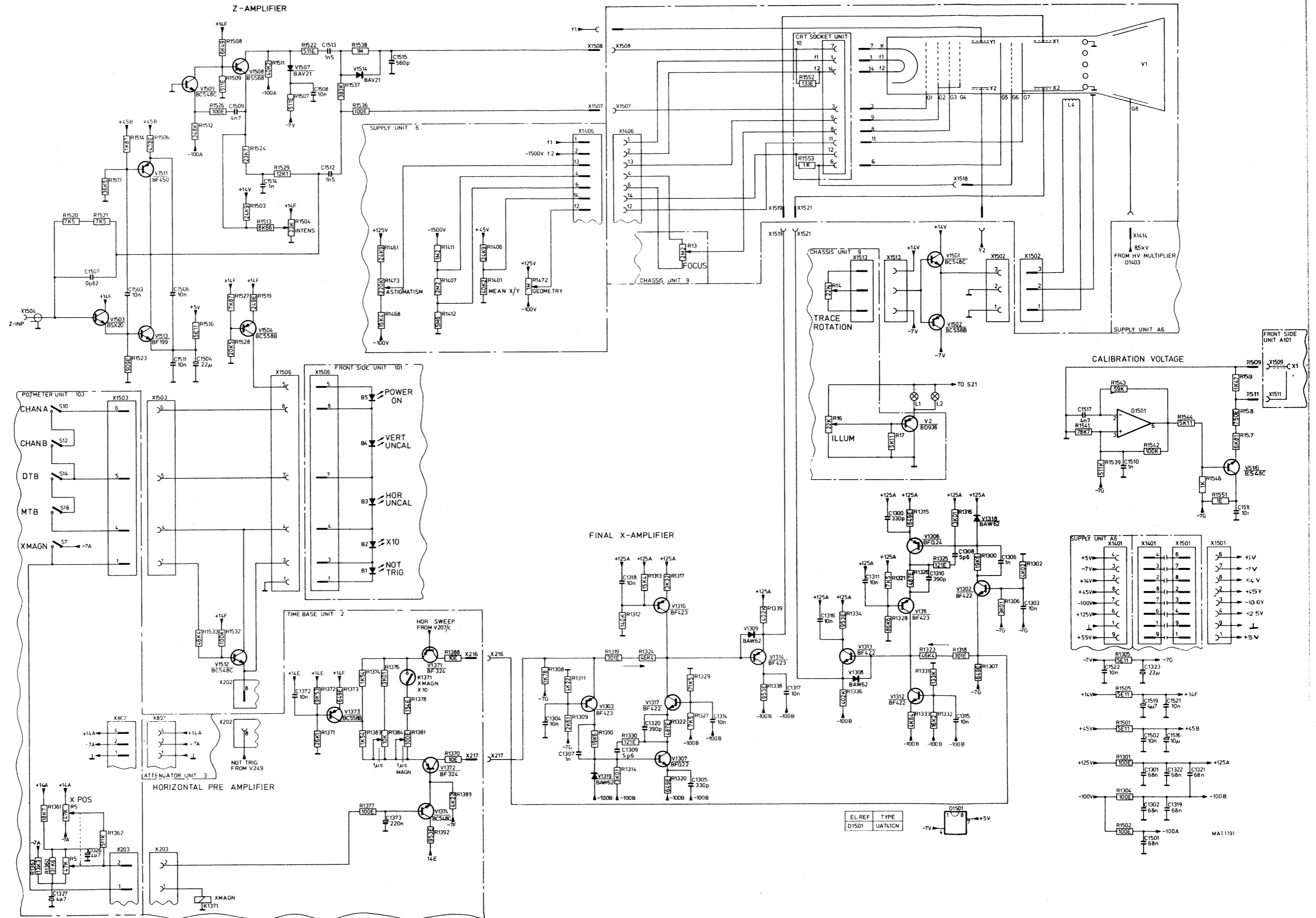
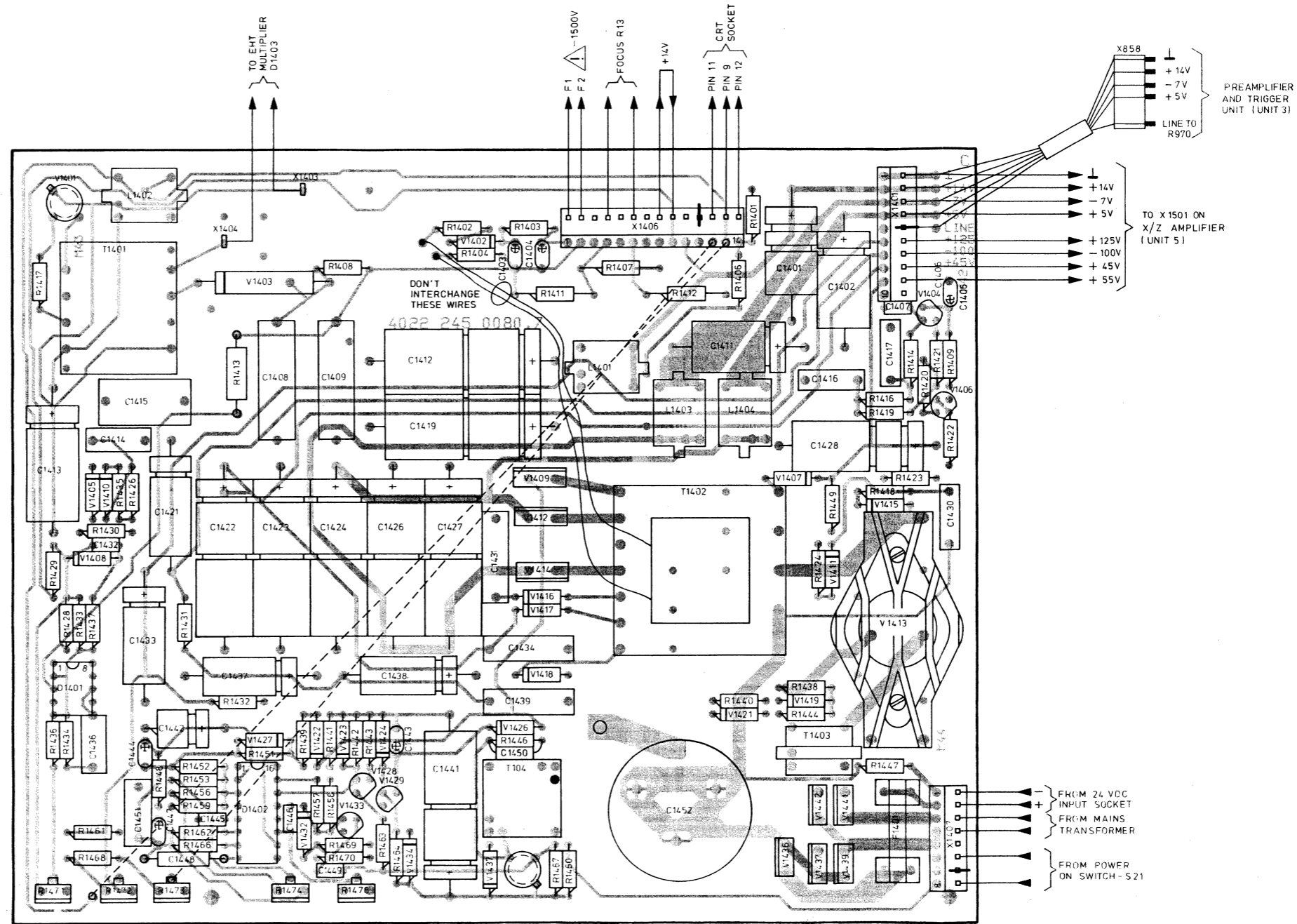

Fig. 8.13. Circuit diagram final X-amplifier, calibration unit and display section



MAT 1192

Fig. 8.14. Power supply unit (unit 6), p.c.b. lay-out

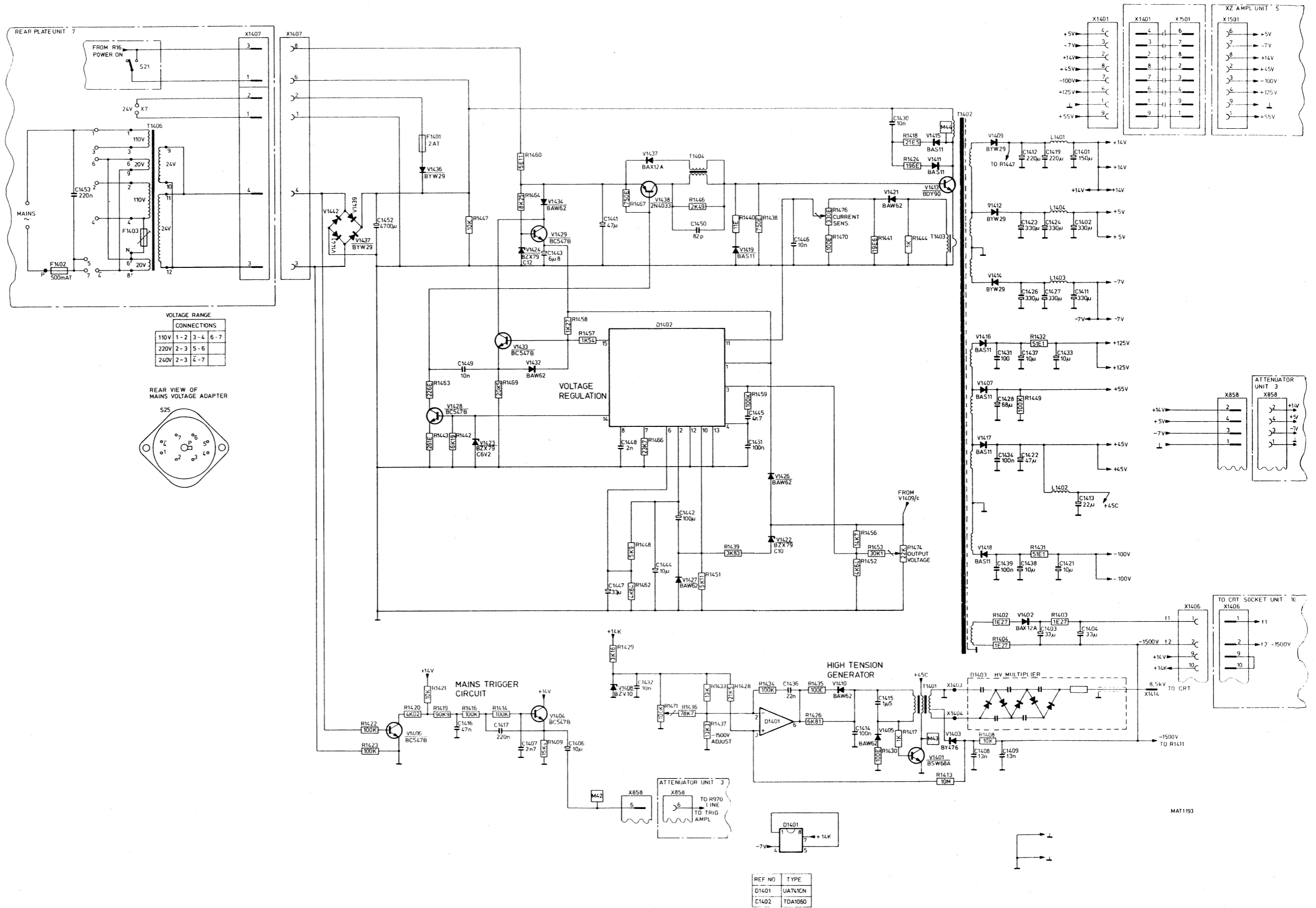

Fig. 8.15. Circuit diagram of power supply and H. V. generator

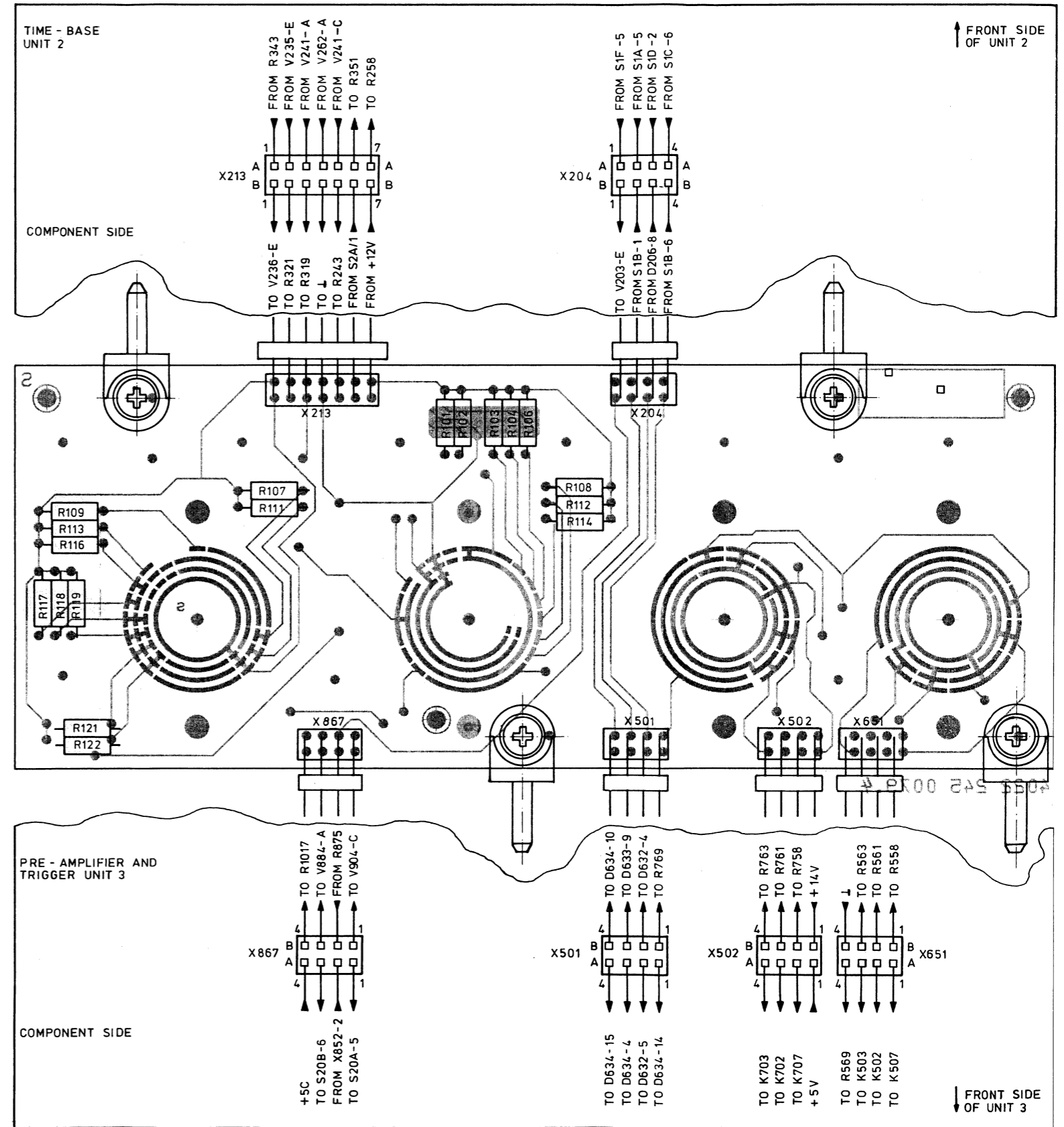

Fig. 8.16. Switch unit (unit 102), p.c.b. lay-out

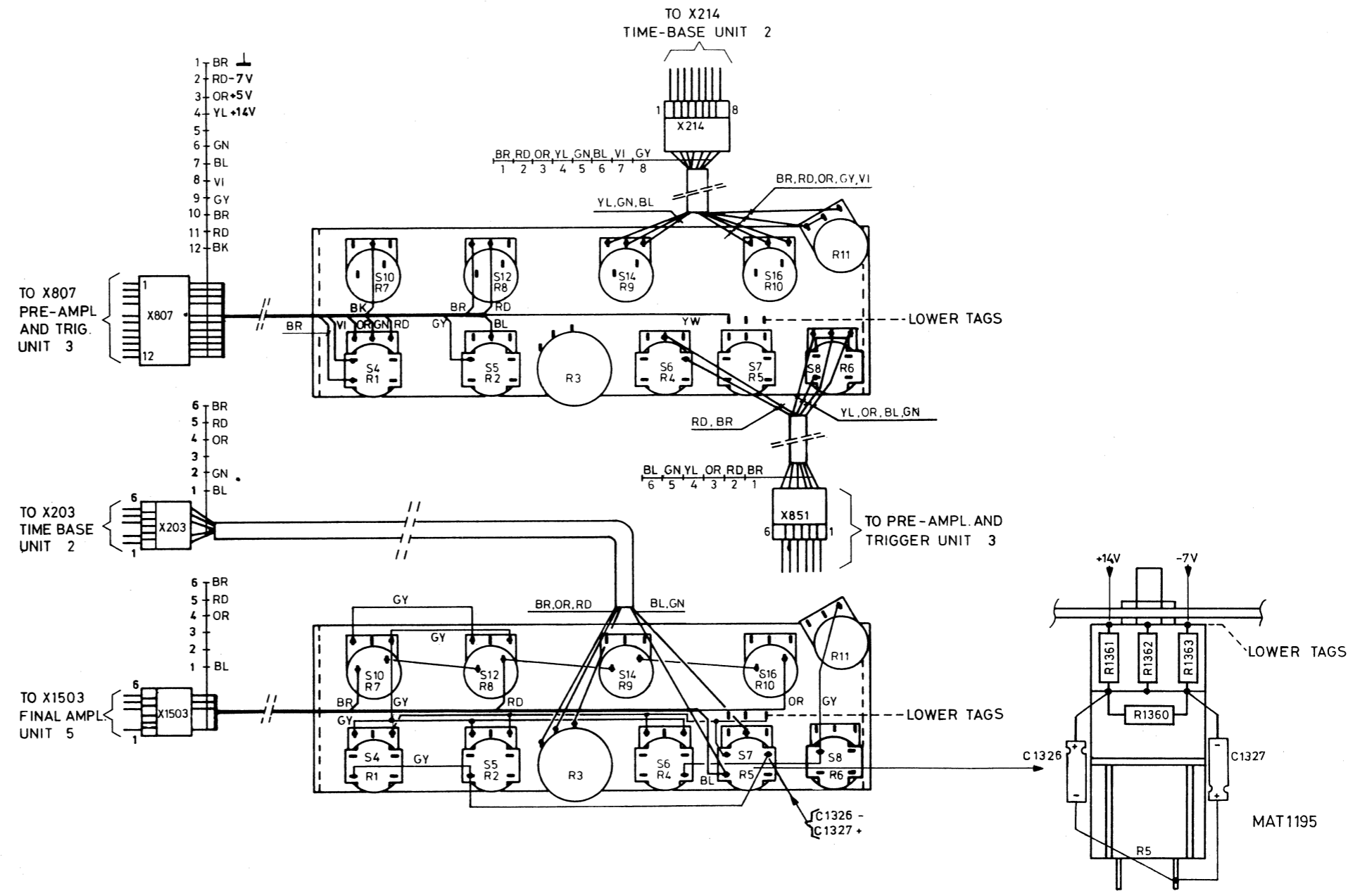

Fig. 8.17. Potentiometer unit (unit 103), wiring lay-out

9. VOLTAGE WAVEFORMS IN THE INSTRUMENT

9.1. INTRODUCTION

The waveforms given in this chapter are typical values and represent an average instrument. So the waveforms measured in your "oscilloscope under test" can differ somewhat from the values given in this manual. The waveforms are listed in 3 chapters:

9.2. Vertical deflection and triggering

9.3. Horizontal deflection

9.4. Power supply

The measurement can be started at every desired point because settings of "measuring oscilloscope" and "oscilloscope under test" that differ from the "standard" settings are indicated beside the waveforms. The test points are marked on the units.

The required test equipment consists of an oscilloscope of 100 MHz (e.g. Philips PM 3262) with a suitable **10:1 attenuator probe**.

The input square wave signal for the "oscilloscope under test" can be obtained from a function generator (e.g. Philips PM 5127).

Standard-settings for the "oscilloscope under test"

- Depress the Y-position controls to the non-inverted position (S4 and S5).
- Push the channel A and B signal coupling switches in the AC position (S17 and S18).
- Depress pushbutton A (or B) of the vertical display mode selector S1.
- Set the channel A and B AMPL/DIV controls in the 1 V/div. position and their verniers to CAL.
- Depress pushbutton MTB of the horizontal display mode selector (S2).
- Depress the time base magnifier X MAGN (S7).
- Depress pushbutton AUTO PP of trigger mode selector (S3).
- Set the MTB in the 0.1 ms/div. position and its vernier to CAL.
- Set the DTB TIME/DIV switch in the OFF position and its vernier to CAL.
- Depress pushbutton DC of the MTB and DTB trigger coupling controls (S20 and S19).
- Depress pushbutton A (or B) of the MTB trigger source selector (S23).
- Depress pushbutton MTB of the DTB trigger source selector (S22).
- Apply a square-wave signal on 6 V_{p-p}/10 kHz to the input sockets A, B and EXT.
- Set the signal in the middle of the screen by means of the channel A (or B) position controls (R1 and R2).
- Set the HOLD OFF control in the CAL position.
- Adjust the DELAY TIME control to 5,00.

Standard-settings of the "measuring oscilloscope"

- The waveforms are measured on channel A, the required AMPL/DIV position is indicated beside every waveform.
- The vertical position of the main time base line without input signal is indicated beside every waveform with a "0".
- The instrument is triggered on channel A.
- Only the MTB is used and the required TIME/DIV position is indicated beside every waveform.
- The MTB trigger coupling control occupies the DC position.

The units on which voltage waveforms can be measured are:

Unit 2: Time base unit

Unit 3: Preamplifier and trigger unit; for measurements on test points M23 ... M29, the trigger source selection unit must be lifted.

Unit 4: Trigger selection unit, the test point on this unit (M27) is not indicated. For the location of M27 refer to the p.c.b. lay-out of the unit.

Unit 6: Power supply.

9.2 VERTICAL DEFLECTION AND TRIGGERING

Unit 3

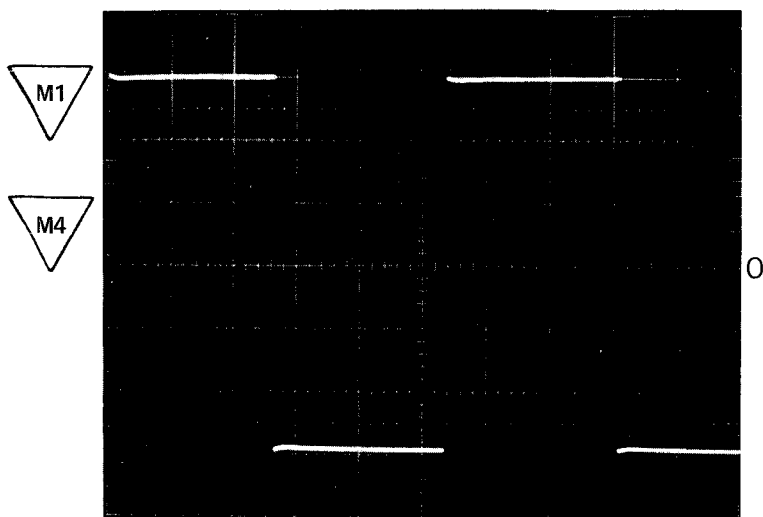

Measuring oscilloscope:
 0.1 V/div.
 20 μ s/div.
 DC input coupling
 Oscilloscope under test:
 M1 = channel A
 M4 = channel B

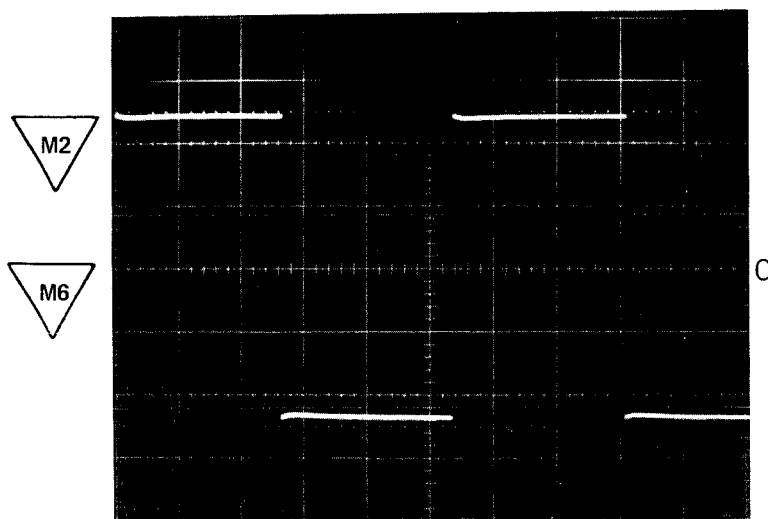

Measuring oscilloscope:
 10 mV/div.
 20 μ s/div.
 DC input coupling
 Oscilloscope under test:
 M2 = channel A
 M6 = channel B

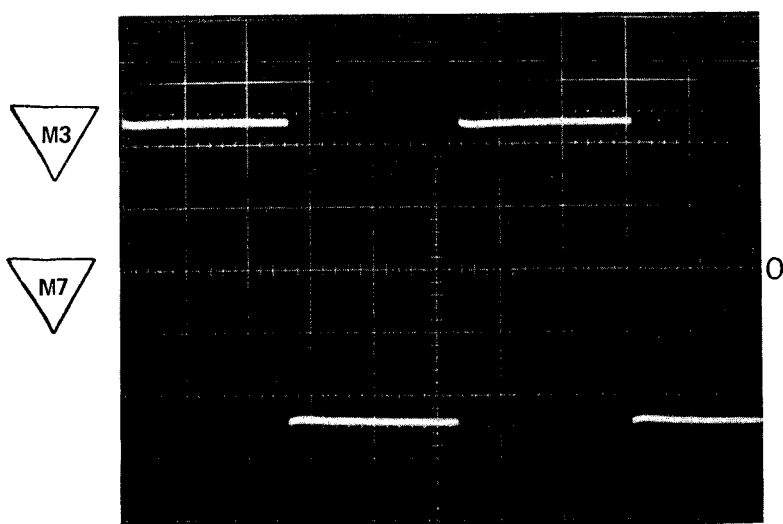

Measuring oscilloscope:
 2 mV/div.
 20 μ s/div.
 DC input coupling
 Oscilloscope under test:
 M3 = channel A
 M7 = channel B

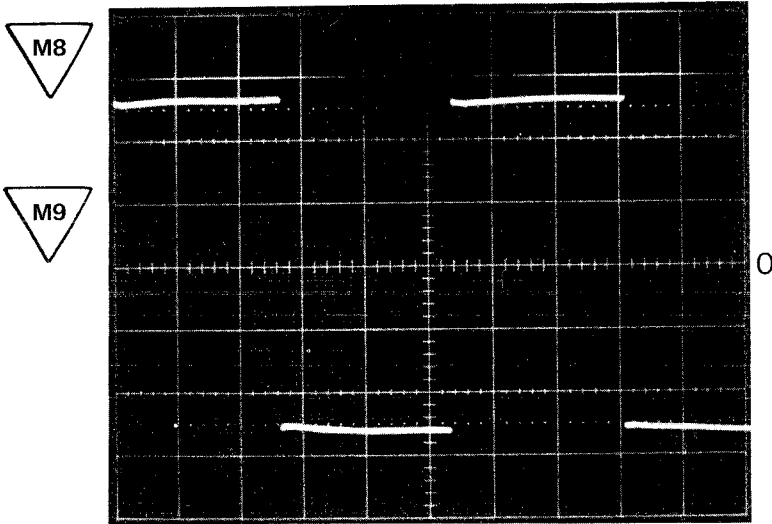

Measuring oscilloscope:
 5 mV/div.
 20 μ s/div.
 AC input coupling
 Oscilloscope under test:
 Select vertical display (S1)
 via channel A and B.

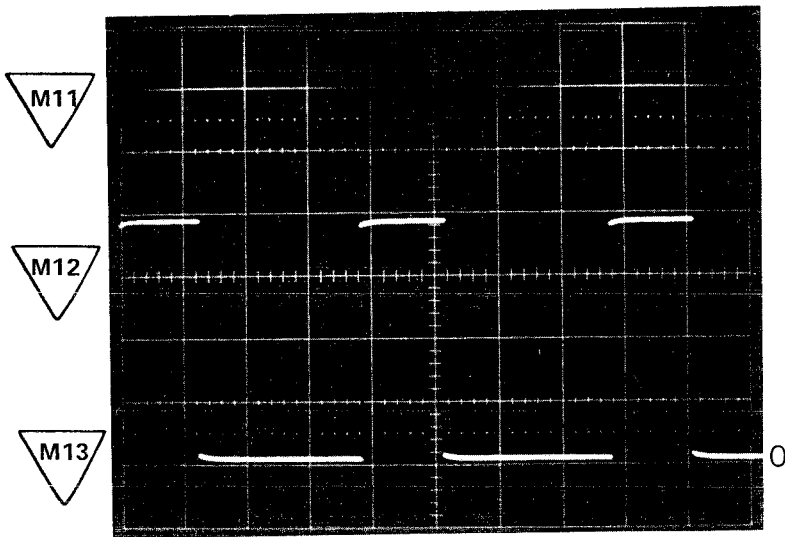

Measuring oscilloscope:
 0.1 V/div.
 1 ms/div.
 DC input coupling
 Oscilloscope under test:
 Select vertical display mode
 (S1) ALT combined with
 TRIG VIEW

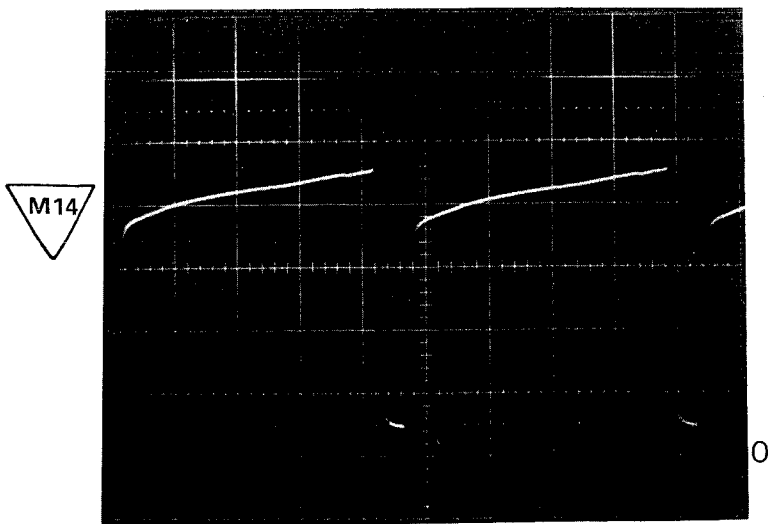

Measuring oscilloscope:
 0.1 V/div.
 0.2 μ s/div.
 DC input coupling
 Oscilloscope under test:
 Select vertical display mode
 (S1) CHOP

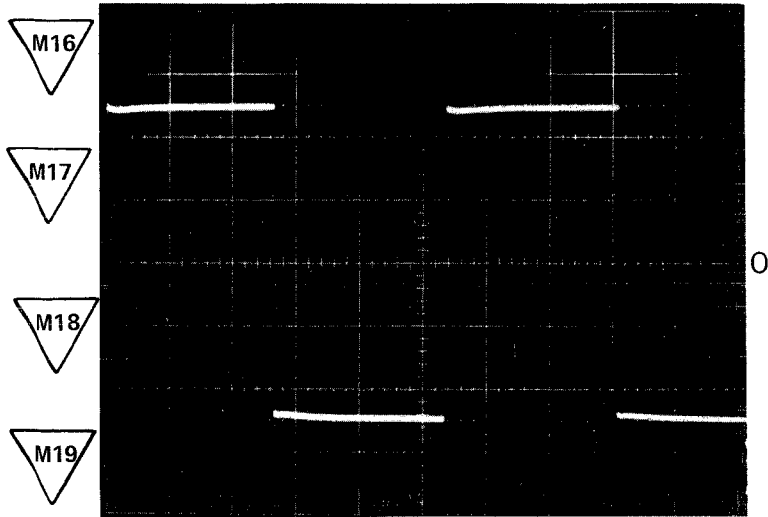

Measuring oscilloscope:
 5 mV/div.
 20 μ s/div.
 AC input coupling

Oscilloscope under test:
 M16/M17: MTB triggering on channel A.
 M18/M19: MTB triggering on channel B.

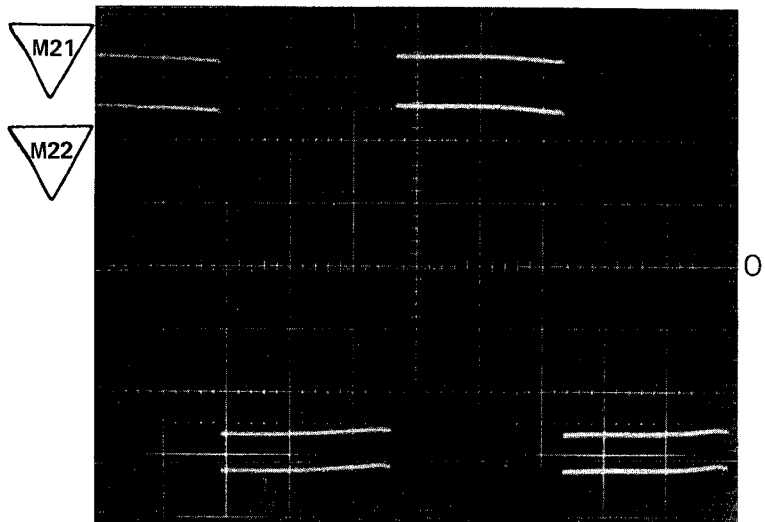

Measuring oscilloscope:
 5 mV/div.
 20 μ s/div.
 AC input coupling

Oscilloscope under test:
 MTB triggering via COMP.
 Waveform depends on channel A and B position control.
 Depress ALT of S1

NOTE: For the following measurements the Trigger selection unit must be lifted.

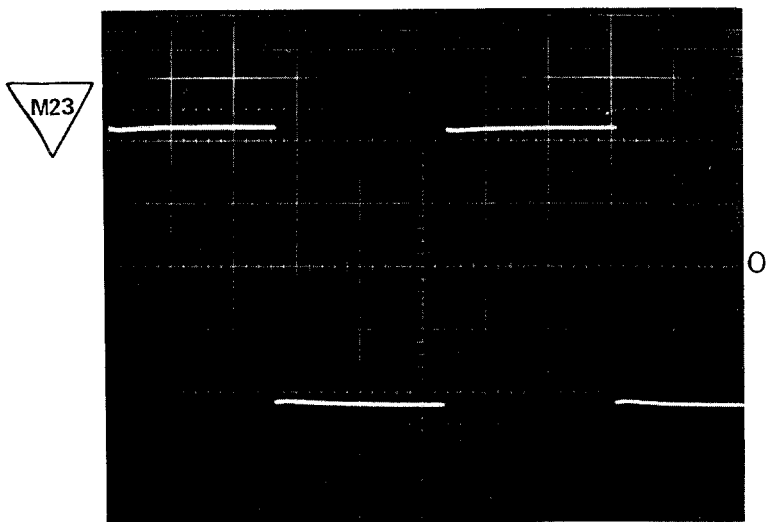

Measuring oscilloscope:
 20 mV/div.
 20 μ s/div.
 AC input coupling

Oscilloscope under test:
 Select MTB triggering via channel A and B.

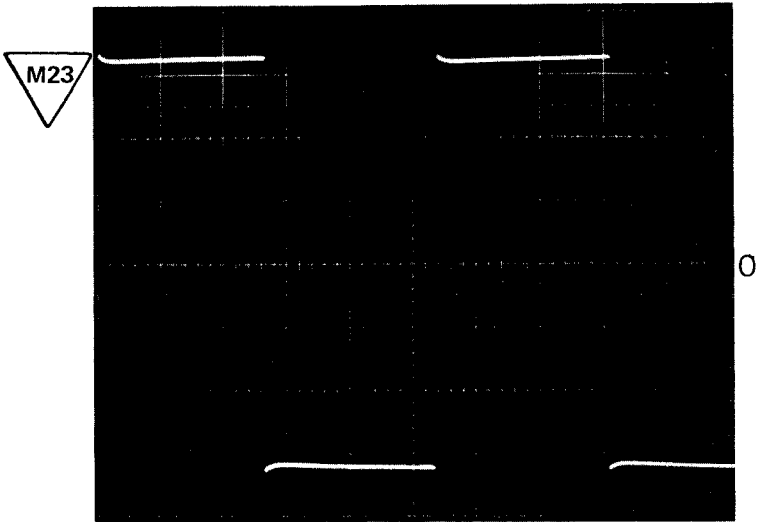

Measuring oscilloscope:
 20 mV/div.
 20 μ s/div.
 AC input coupling

Oscilloscope under test:
 Select MTB triggering via the EXT
 input. Apply the channel A/B input
 signal to EXT input socket.

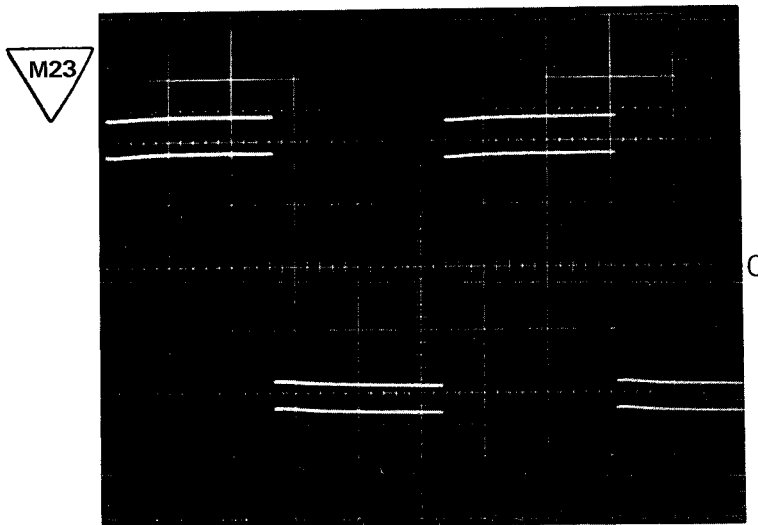

Measuring oscilloscope:
 20 mV/div.
 20 μ s/div.
 AC input coupling

Oscilloscope under test:
 Select MTB triggering via COMP.
 Waveform depends on channel A
 and B position controls.

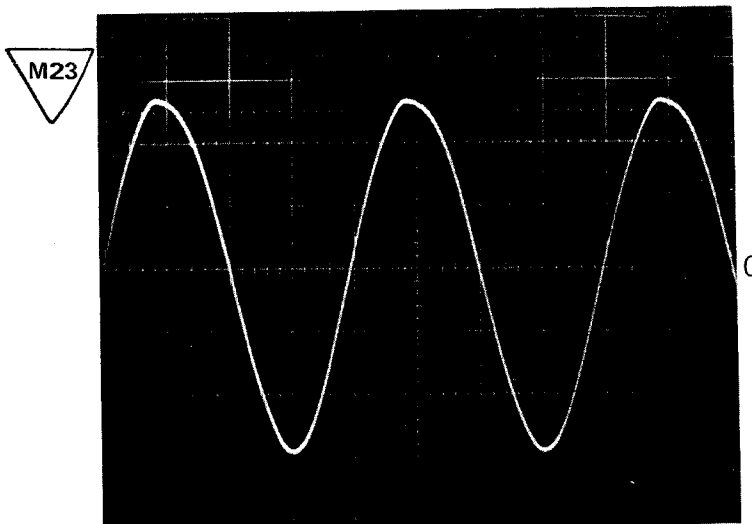

Measuring oscilloscope:
 20 mV/div.
 5ms/div.
 AC input coupling

Oscilloscope under test:
 Select MTB triggering via LINE.

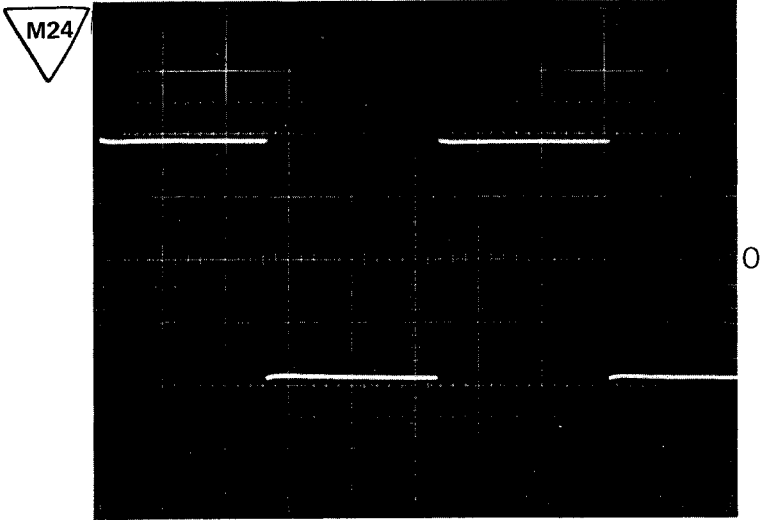

Measuring oscilloscope:
20 mV/div.
20 μ s/div.
AC input coupling
Oscilloscope under test:
DC trigger coupling of MTB.

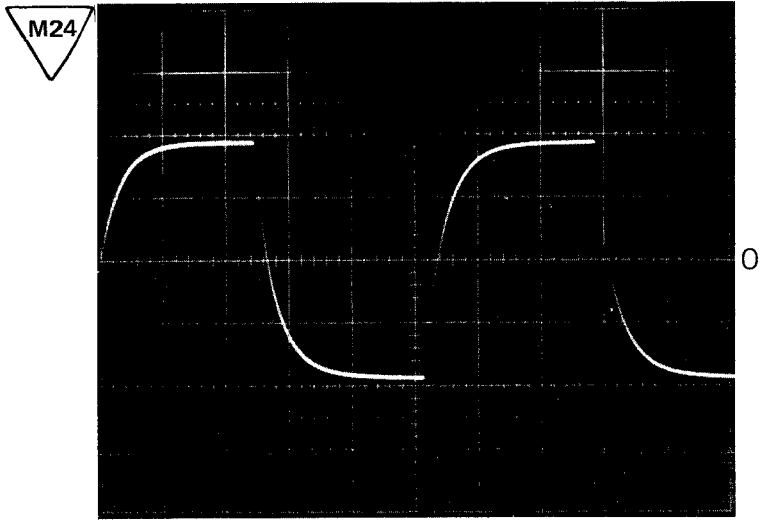

Measuring oscilloscope:
20 mV/div.
20 μ s/div.
AC input coupling
Oscilloscope under test:
LF trigger coupling of MTB.

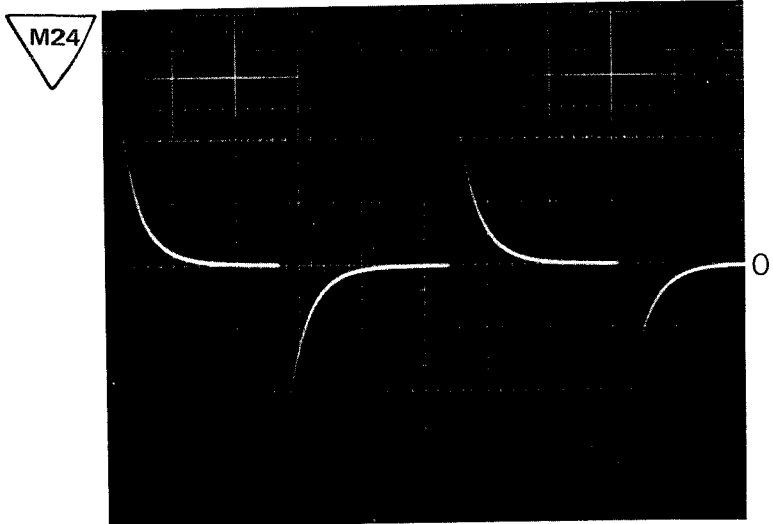

Measuring oscilloscope:
20 mV/div.
20 μ s/div.
AC input coupling
Oscilloscope under test:
HF trigger coupling of MTB.

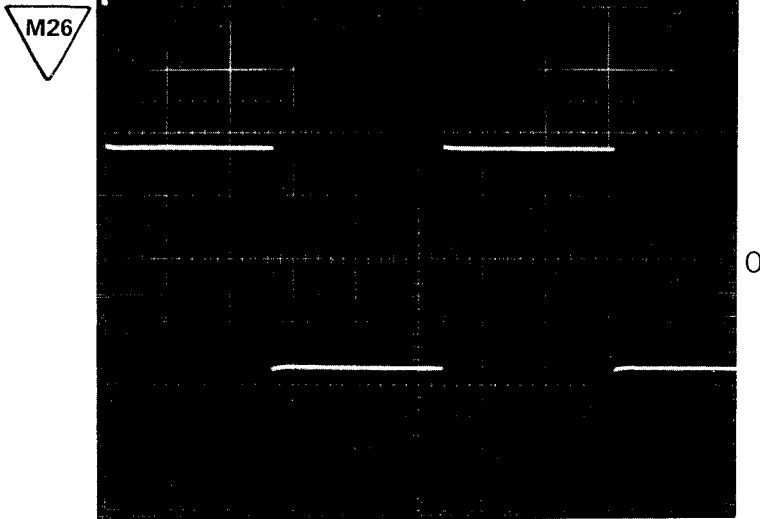

Measuring oscilloscope:
 50 mV/div.
 20 μ s/div.
 AC input coupling

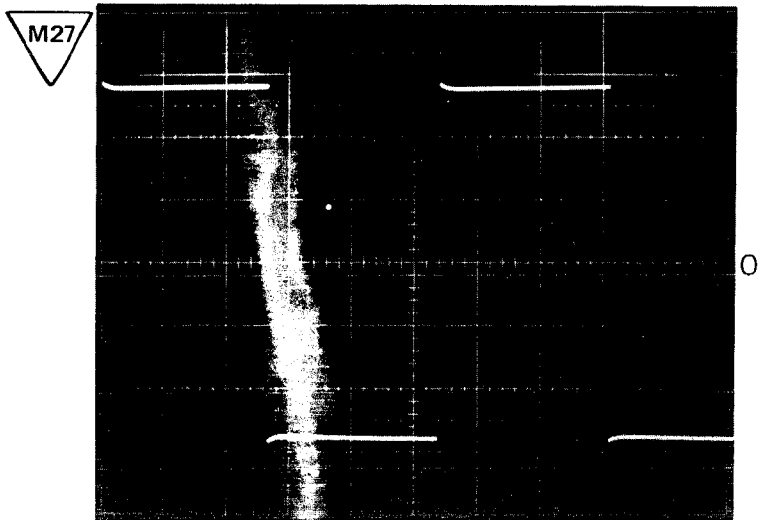

Measuring oscilloscope:
 10 mV/div.
 20 μ s/div.
 AC input coupling

Oscilloscope under test:
 This test point is located on the
 trigger selection unit.
 Select MTB triggering via the EXT
 input. Apply the channel A/B input
 signal to the EXT input socket.

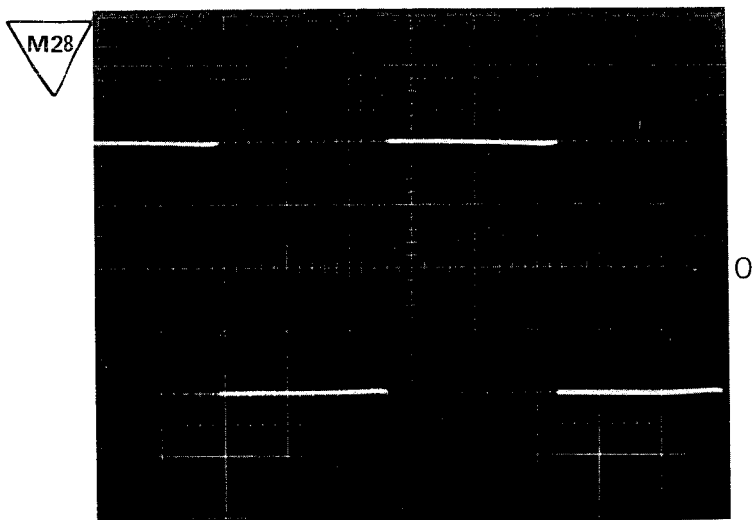

Measuring oscilloscope:
 20 mV/div.
 20 μ s/div.
 AC input coupling

Oscilloscope under test:
 Select DTB triggering on channel
 A and B

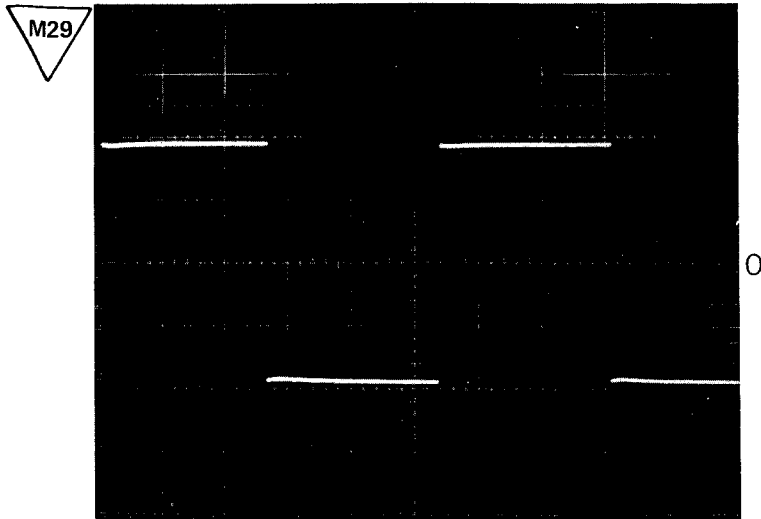

Measuring oscilloscope:
 20 mV/div.
 20 μ s/div.
 AC input coupling

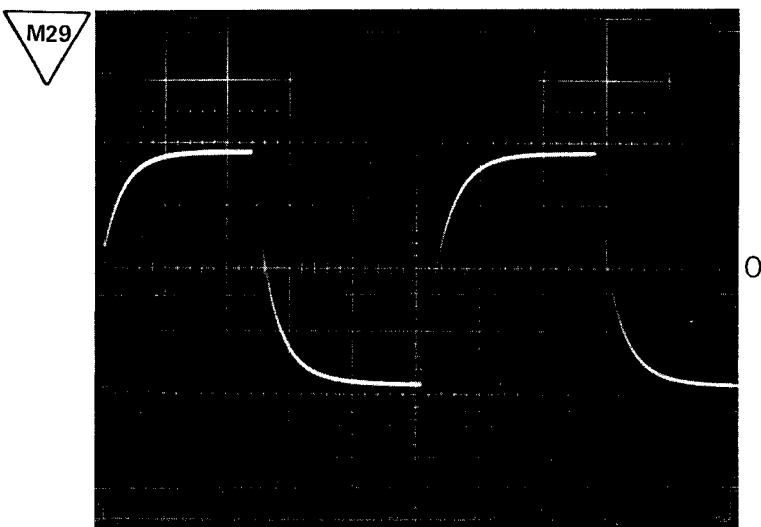

Measuring oscilloscope:
 20 mV/div.
 20 μ s/div.
 AC input coupling.
 Oscilloscope under test:
 LF trigger coupling of DTB.

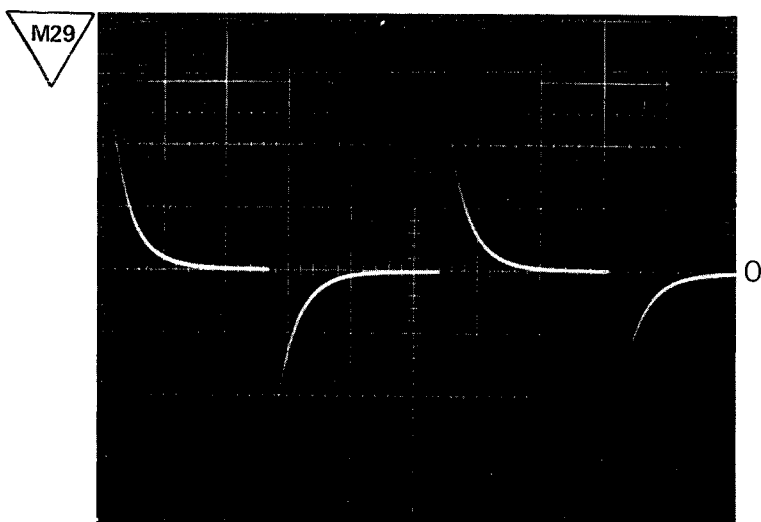

Measuring oscilloscope:
 20 mV/div.
 20 μ s/div.
 AC input coupling
 Oscilloscope under test:
 HF trigger coupling of DTB.

9.3 HORIZONTAL DEFLECTION

Unit 2

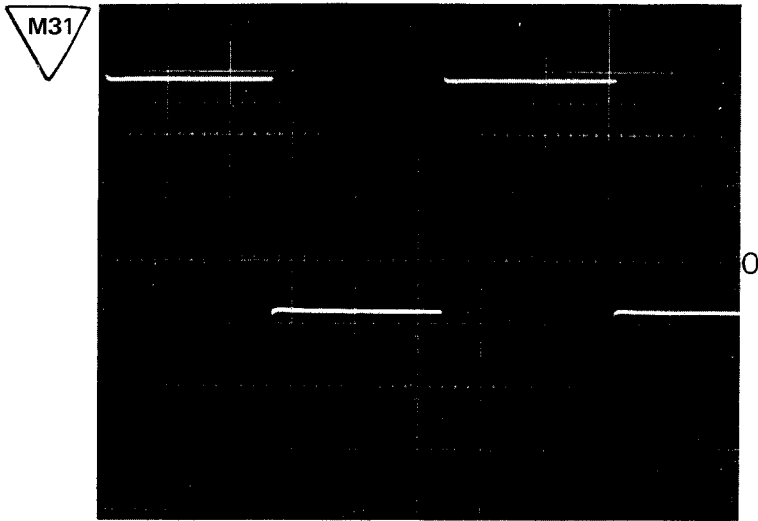

Measuring oscilloscope:
0.1 V/div.
20 μ s/div.
DC input coupling

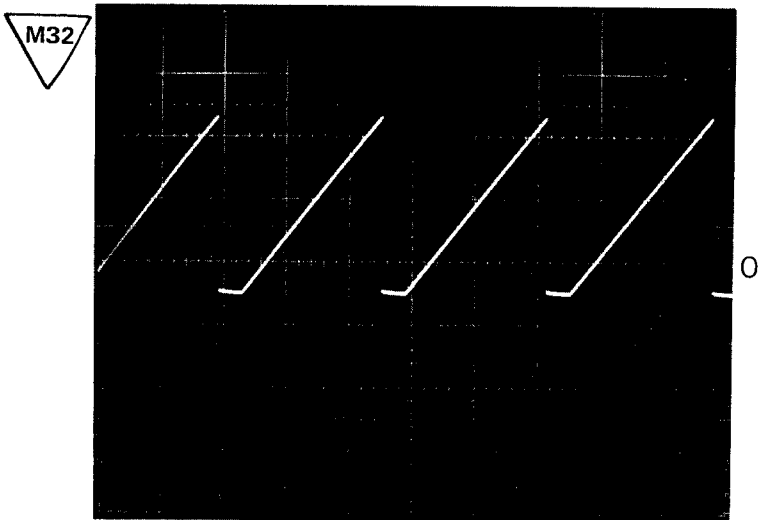

Measuring oscilloscope:
0.2 V/div.
0.5 ms/div.
DC input coupling

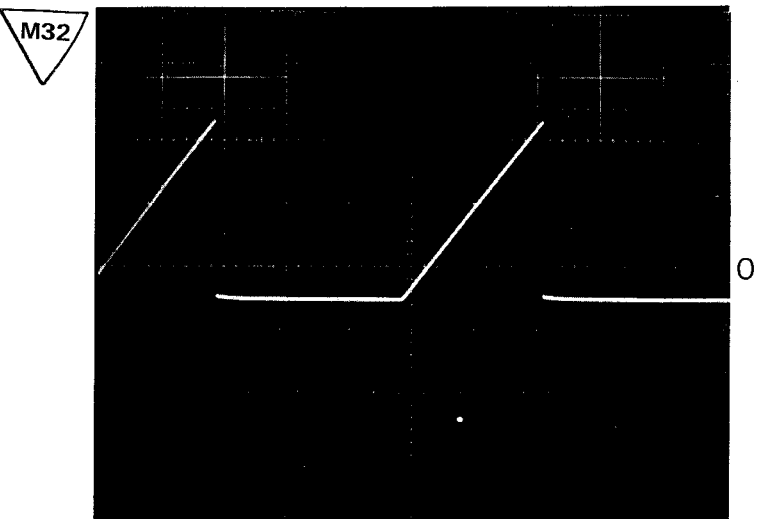

Measuring oscilloscope:
0.2 V/div.
0.5 ms/div.
DC input coupling
Oscilloscope under test:
Turn the HOLD OFF control
fully anti-clockwise.

M32

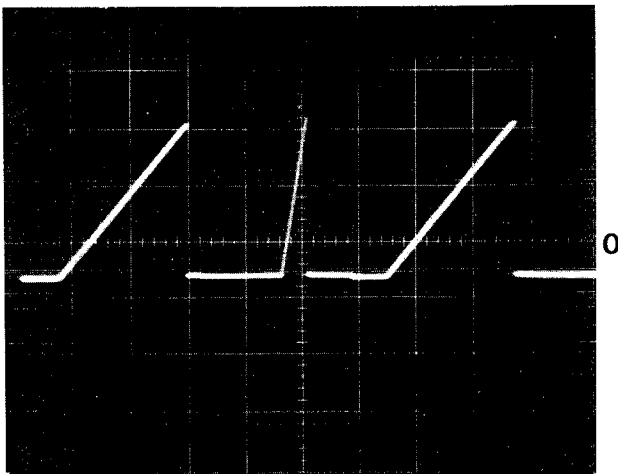

Measuring oscilloscope:
 0.2 V/div.
 0.5 ms/div.
 DC input coupling.
 Oscilloscope under test:
 Select ALT TB mode (S2).
 Adjust the DTB to $20\mu\text{s}/\text{div}$.
 Operate the HOLD OFF control to
 avoid "double" triggering.

M33

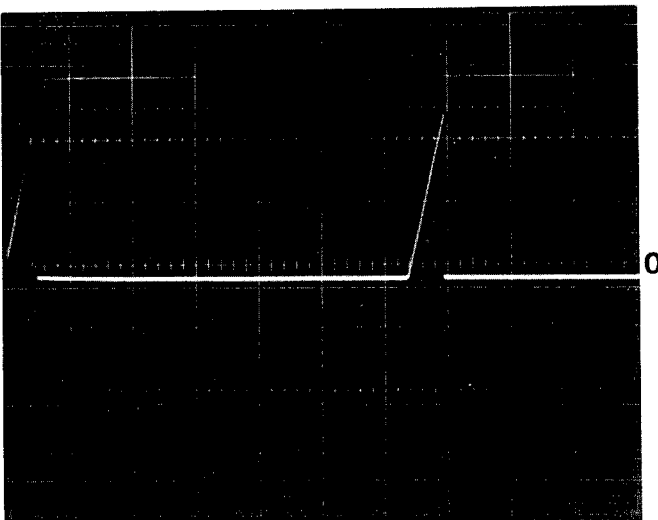

Measuring oscilloscope:
 0.2 V/div.
 0.2 ms/div.
 DC input coupling.

M34

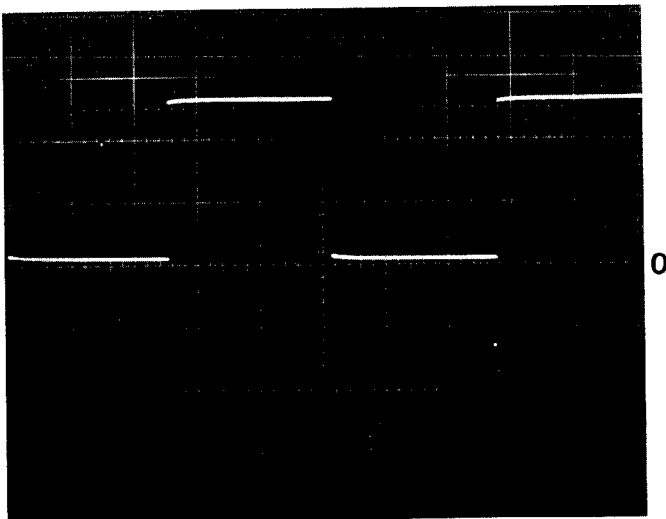

Measuring oscilloscope:
 0.2 V/div.
 0.5 ms/div.
 DC input coupling.
 Oscilloscope under test:
 Select ALT TB mode (S2).
 Adjust the DTB to $20\mu\text{s}/\text{div}$.

M36

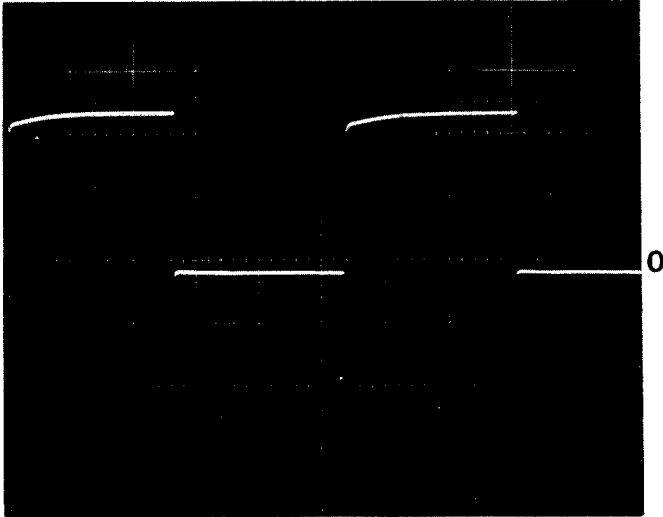

Measuring oscilloscope:
 0.1 V/div.
 20 μ s/div.
 DC input coupling

Oscilloscope under test:
 Adjust the DTB to 20 μ s/div.
 Select ALT TB mode (S2).
 Depress A of S22

M37

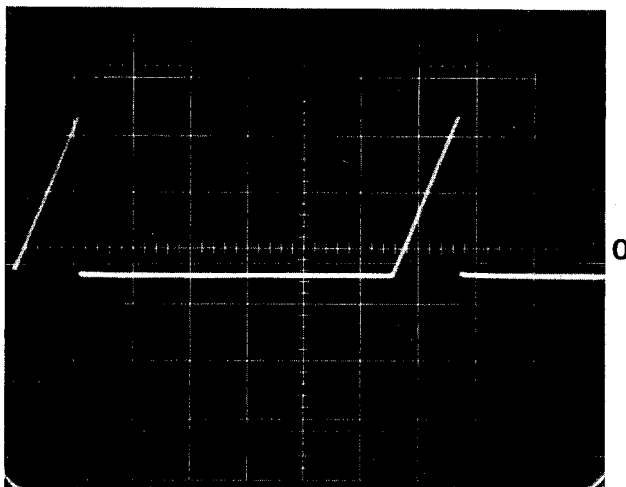

Measuring oscilloscope:
 0.2 V/div.
 0.2 ms/div.
 DC input coupling.

Oscilloscope under test:
 Adjust the DTB to 20 μ s/div.
 Select DTB mode (S2).

M38

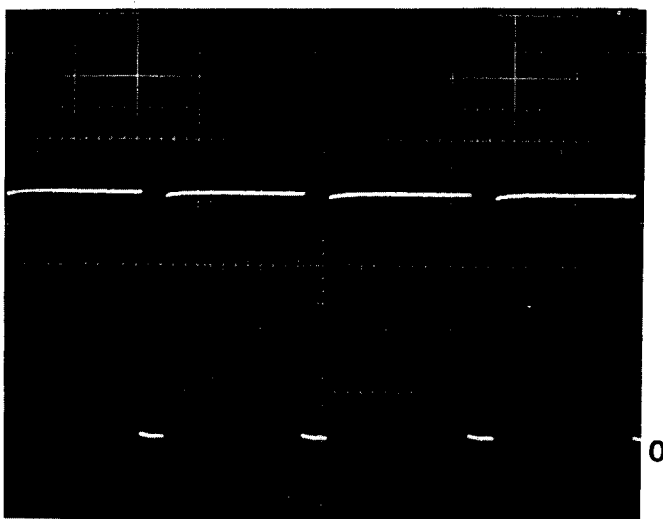

Measuring oscilloscope:
 0.1 V/div.
 0.5 ms/div.
 DC input coupling.

Oscilloscope under test:
 Adjust the DTB to 20 μ s/div.
 Select DTB mode (S2).

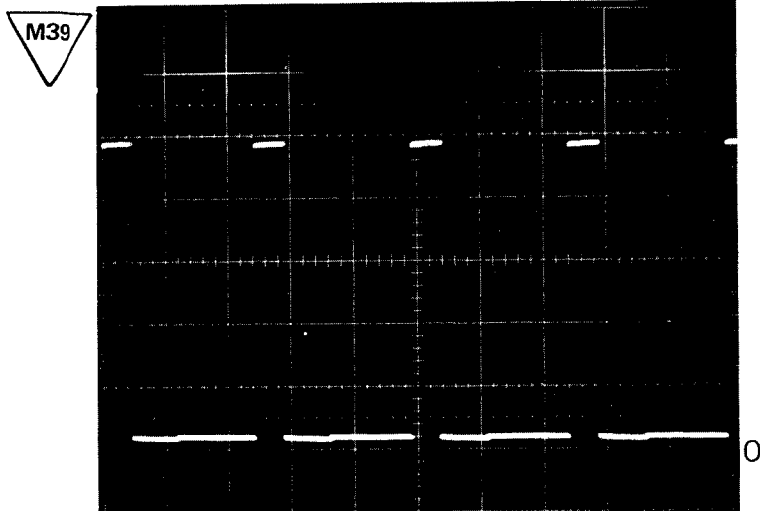

Measuring oscilloscope:

0.1 V/div.

0.5 ms/div.

DC input coupling

Oscilloscope under test:

Adjust the DTB to 20 μ s/div.

Select DTB mode (S2).

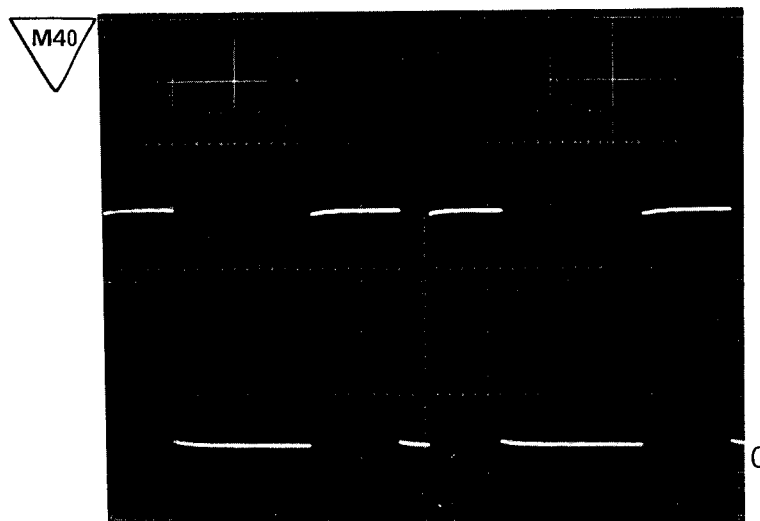

Measuring oscilloscope:

0.1 V/div.

0.5 ms/div.

DC input coupling.

Oscilloscope under test:

Adjust the DTB to 20 μ s/div.

Select ALT TB mode (S2).

Operate the HOLD OFF control
to avoid "double" triggering.

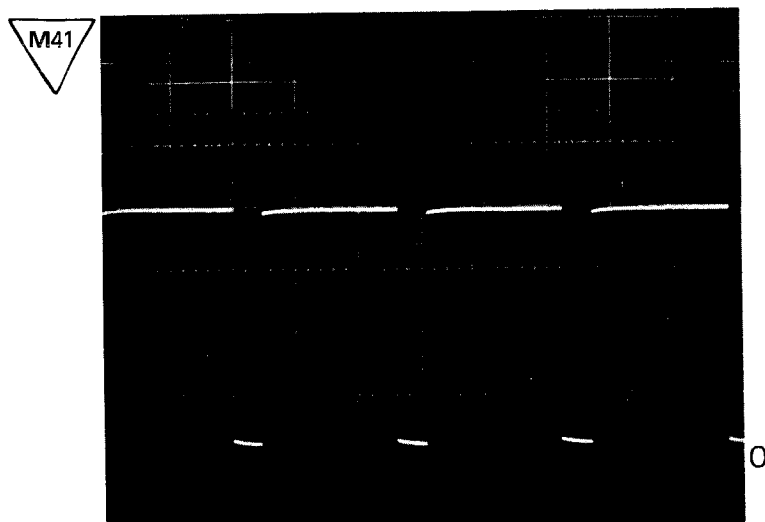

Measuring oscilloscope:

0.1 V/div.

0.5 ms/div.

DC input coupling

Oscilloscope under test:

Adjust the DTB to 20 μ s/div.

Select ALT TB mode (S2).

9.4. POWER SUPPLY

Unit 6

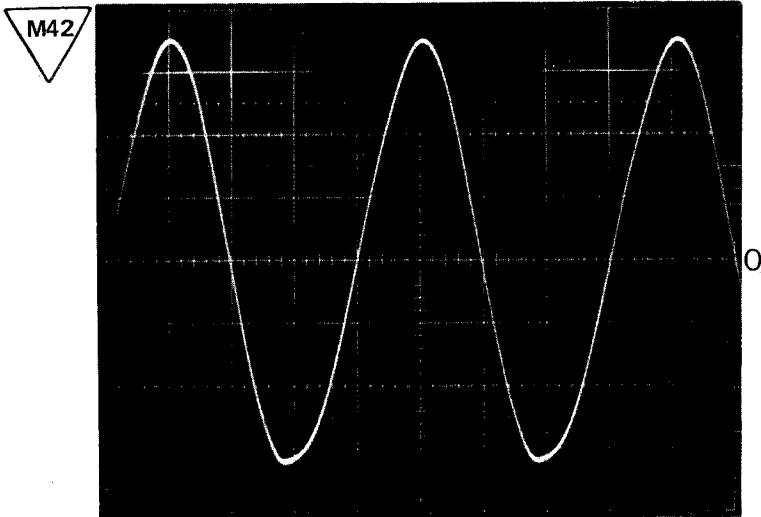

Measuring oscilloscope:
0.1 V/div.
5 ms/div.
DC input coupling

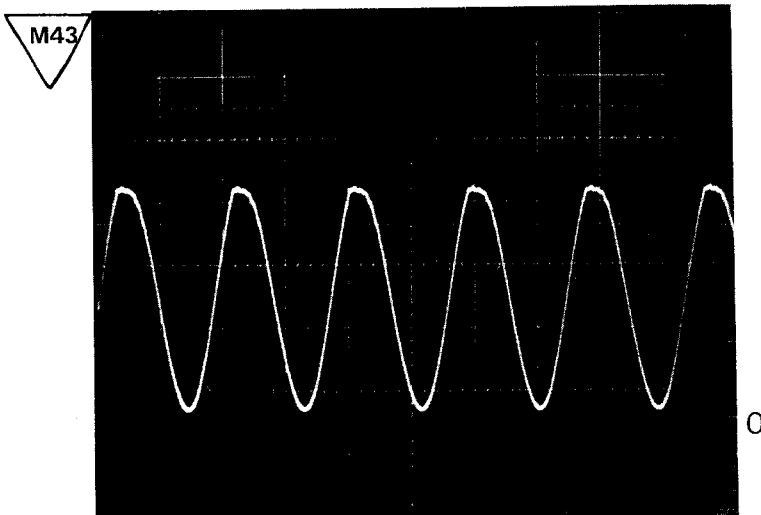

Measuring oscilloscope:
2 V/div.
20 μ s/div.
DC input coupling

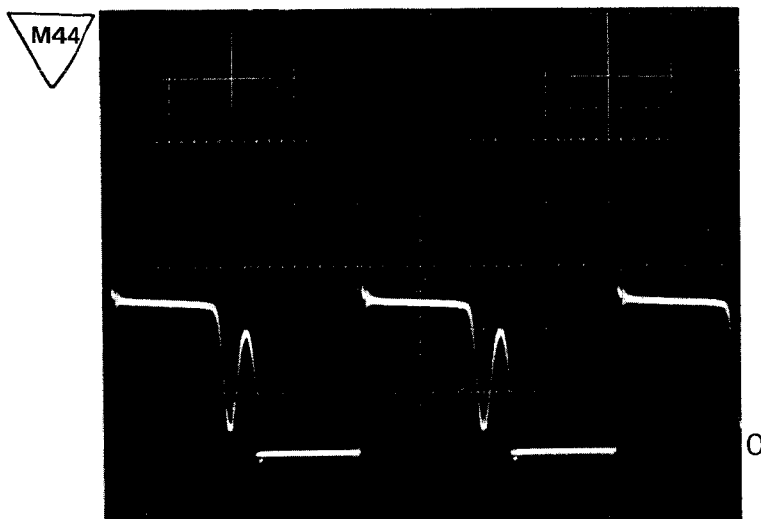

Measuring oscilloscope:
2 V/div.
10 μ s/div.
DC input coupling

10. MODIFICATIONS

MODIFICATIONS:

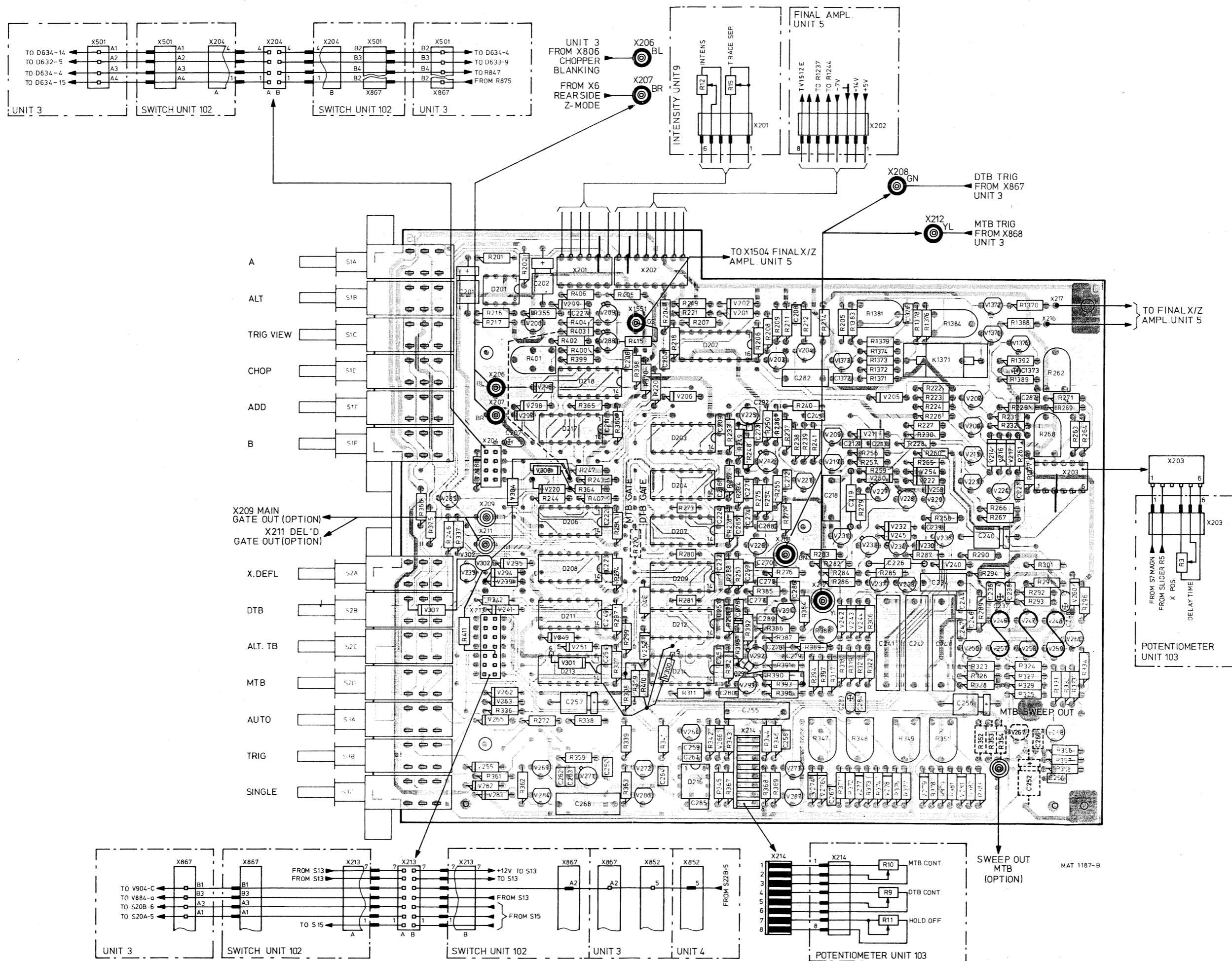

Fig. 1. Time base unit, p.c.b. lay out.

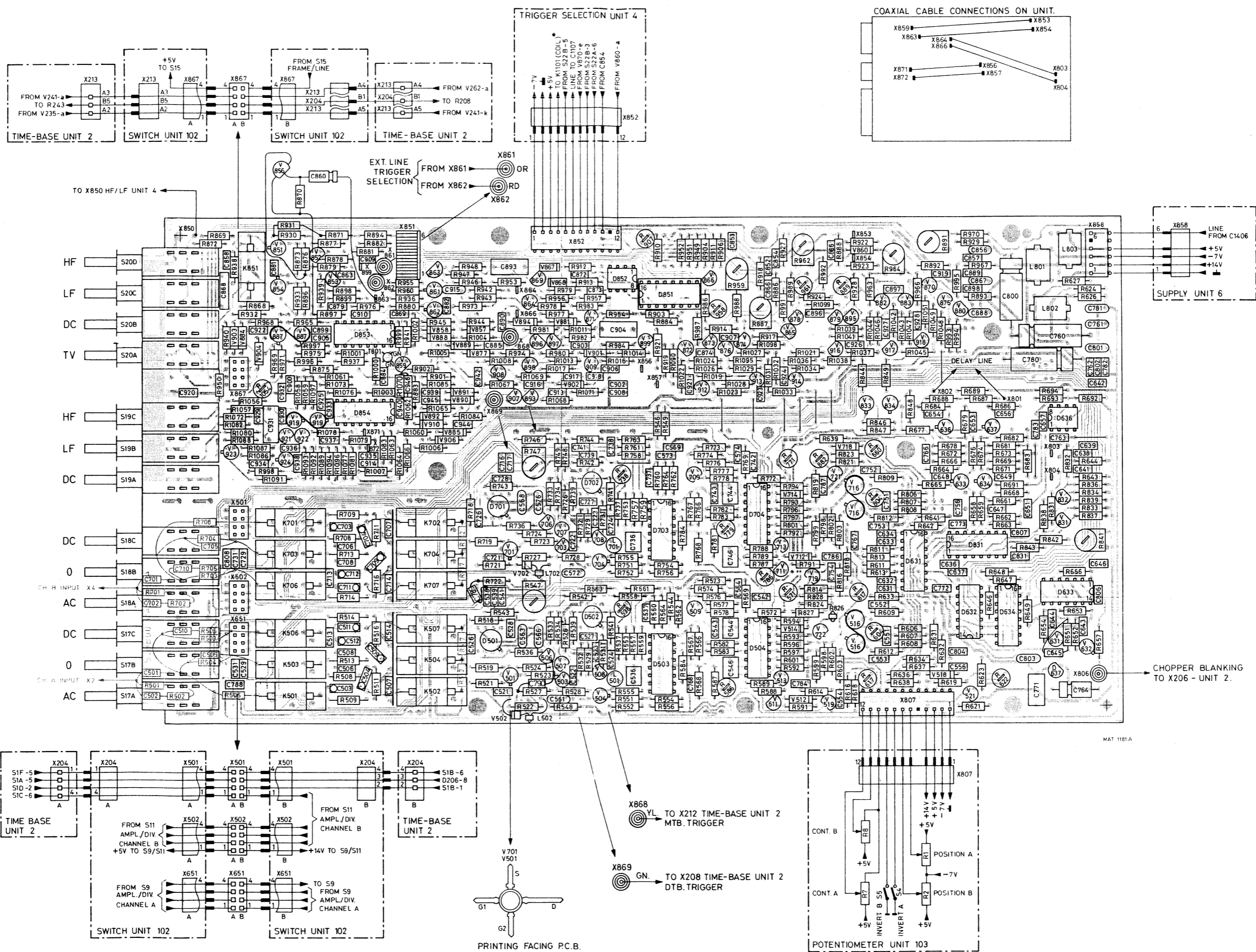

Fig. 2. Preamplifier and trigger unit, p.c.b. lay out.

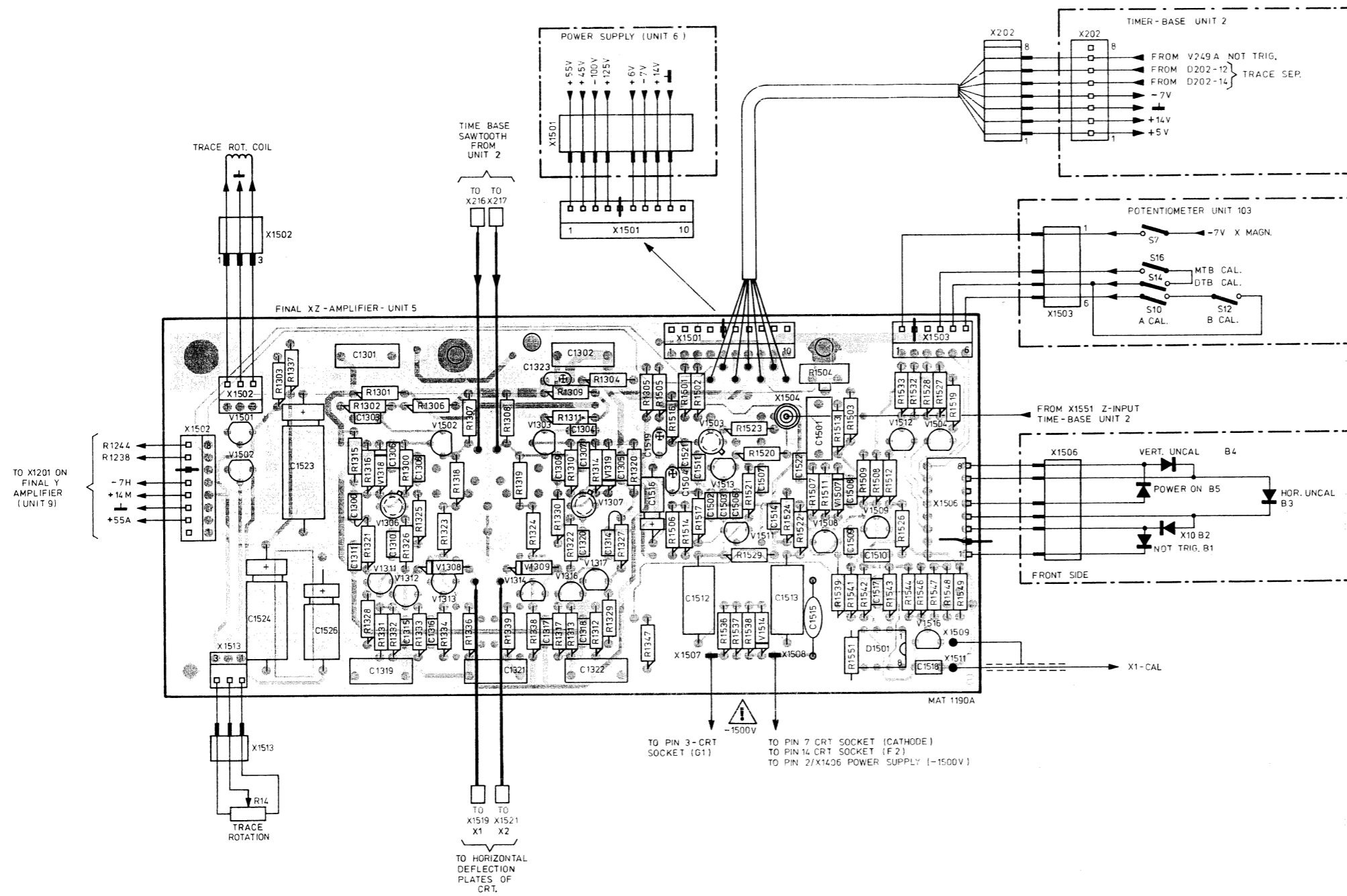

Fig. 3. Final X/Z amplifier, p.c.b. lay out.

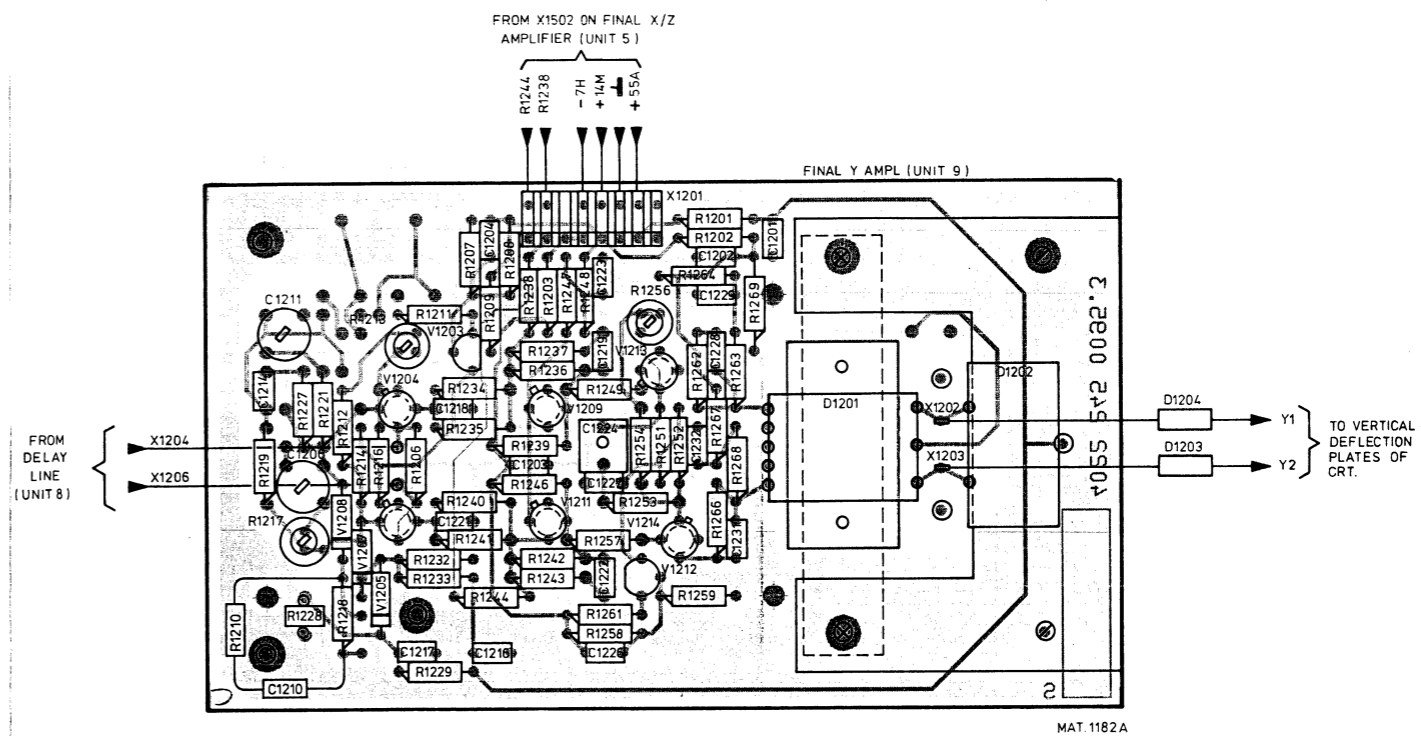

Fig. 4. Final Y amplifier, p.c.b. lay out.



PHILIPS

SERVICE

Scientific & Analytical Equipment
Test & Measuring Instruments
Industrial Automation
Advanced Automation Systems
Welding

Scientific &
Industrial
Equipment
Division

01-07-83

TEST AND MEASURING EQUIPMENT

OSC 159

OSCILLOSCOPE PM 3267/02

Already published: OSC 149.

Subject: modifications introduced starting with the /02 production series.

Note: this service information sheet must be used together with service manual 9499 445 01111.

1. NEW UNITS.

Starting with the /02 production series four printed circuit boards with a modified lay-out are introduced. The differences between the new units and the ones published in your service manual are minimal. The lay-out adaptations concern additional components that were soldered upon the unit and that are now integrated in the printed wiring. The adapted units are:

- Unit 2: time base unit (see fig. 1).
- Unit 3: preamplifier and trigger unit (see fig. 2).
- Unit 5: final X/Z amplifier (see fig. 3).
- Unit 9: final Y amplifier (see fig. 4).

Note: as the new units have the same electrical and mechanical characteristics as the old ones the service ordering codes have not been changed.

2. MODIFICATIONS OF CIRCUITRY.

2.1. Correction of parts list.

- Change C915 from 33uF into 6,8 uF/25V (5322 124 14081).
- Change R538 and R738 into service codenr. 5322 101 14042 (resistance value unchanged).
- Remove C930.
- V852, V853, V921 and V922 must be changed from BF450 into BF324 (4822 130 41448).
- Change C927 and C928 into 2,7 pF (4822 122 31038).
- C861, C862, C911, C963 and C978 are not necessary anymore on the unit.
- V861 and V862 are changed from BF199 into BFQ22S (5322 130 42031).
- Change C710 from 3,3 into 680 pF (4822 122 30053).

9499 448 24111

PRINTED IN THE NETHERLANDS

2.2. This modification avoids bandwidth decrease at higher ambient temperatures in the AMPL/DIV settings 2, 5 and 10 mV/div.

- Change V514 and V714 from BZV46 into BAW62 (4822 130 30613).
- Change R592 and R792 from 348 Ohm into 348 k.Ohm (5322 116 54325).
- Change R601 and R801 from 2,05 k.Ohm into 316 Ohm (5322 116 54511).
- Change R588, R589, R788 and R789 from 1,33 into 1,78 k.Ohm (5322 116 50515).
- Change R573 and R773 from 4,02 into 5,11 k.Ohm (5322 116 54595).
- Change R602, R603, R802 and R803 from 147 into 178 Ohm (5322 116 54492).
- Change R598, R599, R798 and R799 from 909 Ohm into 1,21 k.Ohm (5322 116 54557).
- Change R922 and R923 from 48,7 into 10 Ohm (5322 116 50452).

2.3. For a better trigger view pulse response via the vertical channels.

(In combination with p.c.b. lay out alterations).

- Add C921, C923, C924 and C926 (2,7 pF, 4822 122 31038).
- Add C863 and C879 (15 pF, 4822 122 31058).
- Add C869 (3,3 pF, 4822 122 31041).
- Remove C851 and C864.
- Change C881 from 15 into 27 pF (4822 122 30045).
- Change C896 from 4,7 into 5,6 pF (4822 122 31047).
- Change C910 from 22 into 100 pF (4822 122 31316).
- Change C882 from 1,8 into 0,68 pF (4822 122 31215).
- Change C940 from 68 into 330 pF (4822 122 31353).
- Change C869 from 100 into 1 Ohm (4822 166 51179).
- Remove R874, R934 and R972.
- Change R938 from 46,4 into 133 Ohm (5322 116 54482).
- Change R1082 from 100 into 1 Ohm (4822 116 51179).
- Change R942 and R944 from 48,7 into 1 Ohm (4822 116 51179).

2.4. In order to avoid DTB oscillations.

Add a series circuit consisting of a capacitor C946 (4,7 pF, 4822 122 31045) and a resistor R1070 (51,1 Ohm, 5322 116 54442) between D854/1 and earth.

2.5. For an extended vertical positioning range.

Change R633 and R642 from 1,05 into 1,15 k.Ohm (5322 116 50415).

2.6. For suppression of channel A and B base line distortion at the start of the time base.

- Add a capacitor C789 (10 nF, 4822 122 31414) between the "+14 Volt" side of R722 and the "earth" side of C538 (on conductor side of unit).
- Add a capacitor C790 (10 nF, 4822 122 31414) between the "+14 Volt" side of R527 and the base of V506 (earth). Also this capacitor must be added on the conductor side of the unit.

**CODING SYSTEM OF FAILURE REPORTING FOR QUALITY
ASSESSMENT OF T & M INSTRUMENTS
(excl. potentiometric recorders)**

The information contents of the coded failure description is necessary for our computerized processing of quality data.

Since the reporting of repair and maintenance routines must be complete and exact, we give you an example of a correctly filled-out PHILIPS SERVICE Job sheet.

①	②	③	④																																																							
Country	Day Month Year	Typenumber /Version	Factory/Serial no.																																																							
3 2	1 5 0 4 7 5	O P M 3 2 6 0 0 2	D O 0 0 7 8 3																																																							
CODING SYSTEM OF FAILURE REPORTING FOR QUALITY			⑥																																																							
⑤																																																										
Nature of call	Location	Component/sequence no.	Category																																																							
<input type="checkbox"/> Installation <input type="checkbox"/> Pre sale repair <input type="checkbox"/> Preventive maintenance <input checked="" type="checkbox"/> Corrective maintenance <input type="checkbox"/> Other	<table border="1" style="width: 100%; height: 100%; border-collapse: collapse;"> <tr><td> </td><td> </td><td> </td><td> </td></tr> <tr><td> </td><td> </td><td> </td><td> </td></tr> <tr><td>0</td><td>0</td><td>2</td><td>1</td></tr> <tr><td> </td><td> </td><td> </td><td> </td></tr> <tr><td> </td><td> </td><td> </td><td> </td></tr> </table>									0	0	2	1									<table border="1" style="width: 100%; height: 100%; border-collapse: collapse;"> <tr><td>T</td><td>S</td><td>0</td><td>6</td><td>0</td><td>7</td></tr> <tr><td>R</td><td>0</td><td>0</td><td>6</td><td>3</td><td>1</td></tr> <tr><td>9</td><td>9</td><td>0</td><td>0</td><td>0</td><td>1</td></tr> <tr><td> </td><td> </td><td> </td><td> </td><td> </td><td> </td></tr> <tr><td> </td><td> </td><td> </td><td> </td><td> </td><td> </td></tr> </table>	T	S	0	6	0	7	R	0	0	6	3	1	9	9	0	0	0	1													<table border="1" style="width: 100%; height: 100%; border-collapse: collapse;"> <tr><td>5</td></tr> <tr><td>2</td></tr> <tr><td>4</td></tr> <tr><td> </td></tr> <tr><td> </td></tr> </table>	5	2	4		
0	0	2	1																																																							
T	S	0	6	0	7																																																					
R	0	0	6	3	1																																																					
9	9	0	0	0	1																																																					
5																																																										
2																																																										
4																																																										
			⑦ <input checked="" type="checkbox"/> Job completed Working time ⑧ <table border="1" style="width: 100%; height: 100%; border-collapse: collapse;"> <tr><td> </td><td>1</td><td>2</td></tr> </table> Hrs		1	2																																																				
	1	2																																																								

Detailed description of the information to be entered in the various boxes:

① Country: 3 2 = Switzerland

② Day Month Year 1 5 0 4 7 5 = 15 April 1975

③ Type number/Version O P M 3 2 6 0 0 2 = Oscilloscope PM 3260, version 02 (in later oscilloscopes this number is placed in front of the serial no)

④ Factory/Serial number D O 0 0 7 8 3 = DO 783 These data are mentioned on the type plate of the instrument

⑤ Nature of call: Enter a cross in the relevant box

⑥ Coded failure description

<p>Location</p> <table border="1" style="width: 100%; height: 100%; border-collapse: collapse;"> <tr><td> </td><td> </td><td> </td><td> </td></tr> </table> <p>These four boxes are used to isolate the problem area. Write the code of the part in which the fault occurs, e.g. unit no or mechanical item no of this part (refer to 'PARTS LISTS' in the manual). Example: 0001 for Unit 1 000A for Unit A 0075 for item 75 If units are not numbered, do not fill in the four boxes; see Example Job sheet.</p>					<p>Component/sequence no.</p> <table border="1" style="width: 100%; height: 100%; border-collapse: collapse;"> <tr><td> </td><td> </td><td> </td><td> </td><td> </td><td> </td></tr> </table> <p>These six boxes are intended to pinpoint the faulty component. A. Enter the component designation as used in the circuit diagram. If the designation is alfa-numeric, the letters must be written (starting from the left) in the two left-hand boxes and the figures must be written (in such a way that the last digit occupies the right-most box) in the four right-hand boxes. B. Parts not identified in the circuit diagram: 990000 Unknown/Not applicable 990001 Cabine* r rack (text plate, emblem, grip, rail, graticule, etc.) 990002 Knob (incl. dial knob, cap, etc.) 990003 Probe (only if attached to instrument) 990004 Leads and associated plugs 990005 Holder (valve, transistor, fuse, board, etc.) 990006 Complete unit (p.w. board, h.t. unit, etc.) 990007 Accessory (only those without type number) 990008 Documentation (manual, supplement, etc.) 990009 Foreign object 990099 Miscellaneous</p>							<p>Category</p> <table border="1" style="width: 100%; height: 100%; border-collapse: collapse;"> <tr><td> </td></tr> </table> <p>0 Unknown, not applicable (fault not present, intermittent or disappeared) 1 Software error 2 Readjustment 3 Electrical repair (wiring, solder joint, etc.) 4 Mechanical repair (polishing, filing, remachining, etc.) 5 Replacement (of transistor, resistor, etc.) 6 Cleaning and/or lubrication 7 Operator error 8 Missing items (on pre-sale test) 9 Environmental requirements are not met</p>	

⑦ Job completed: Enter a cross when the job has been completed.

⑧ Working time: Enter the total number of working hours spent in connection with the job (excluding travelling, waiting time, etc.), using the last box for tenths of hours.

1 2 = 1,2 working hours (1 h 12 min.)

Sales and service all over the world

Alger: Bureau de Liaison Philips,
24 bis Rue Bougainville,
El Mouradia, Alger; tel.: 565672

Argentina: Philips Argentina S.A.,
Casilla de Correo 3479, (Central), 1430 Buenos Aires;
tel. (1) 70-12421/70-2325/2905/6488

Australia: Philips Scientific & Industrial
Equipment Division, Centre Court,
25 - 27 Paul Street, P.O. Box 119,
North Ryde/NSW 2113; tel. (2) 888-8222

Bangla Desh: Philips Bangla Desh Ltd.,
P.O. Box 62; Ramna, Dacca; tel. 283332

België/Belgique: Philips and MBE associates,
Philips Scientific and Industrial Equipment Division;
80 Rue des Deux Gares, 1070 Bruxelles,
tel. (2) 523.00.00

Bolivia: Industrias Bolivianas Philips S.A.,
Cajón Postal 2964, La Paz;
tel.: 50029/55270/55604

Brazil: Philips Do Brasil Ltda,
Avenida 9 de Julho 5229, Caixa Postal 8681;
CEP 01407 - Sao Paulo (S.P.);
tel. 2825722

Service Centre:
Sistemas Profissionais
Rua Amador Bueno, 474,
Caixa Postal 3159 - S. Amaro
CEP 04752 - Sto Amara (S.P.);
tel. (11) 2476522

Canada: Philips Test and Measuring Instruments Inc.,
6 Leswyn Road,
Toronto (Ontario) M6A-1K2;
tel. (416) 789-7188

Chile: Philips Chilena S.A.,
Division Profesional, Avda. Santa Maria 0760;
Casilla Postal 2687, Santiago de Chile; tel. 770038

Colombia: Industrias Philips de Columbia S.A.,
Calle 13 no. 51-39, Apartado Aereo 4282,
Bogota; tel. 2600600

Danmark: Philips Elektronik-Systemer A/S,
Afd. for Industri og Forskning, Strandlodsvej 4,
P.O. Box 1919, 2300 København S,
tel. (1) 572222

Deutschland (Bundesrepublik): Philips GmbH,
Unternehmensbereich Elektronik für
Wissenschaft und Industrie, Miramstrasse 87,
Postfach 310 320; 35 Kassel-Bettenhausen;
tel. (561) 5010

Ecuador: Philips Ecuador S.A.,
Casilla 343, Quito; tel. 239080

Egypt: Resident Delegate Office of Philips Industries,
5 Sherif Street, Corner Eloui, P.O. Box 1687, Cairo;
tel. 754118/754259/754077.

Eire: Philips Electrical (Ireland) Ltd.
Newstead, Clonskeagh, Dublin 14; tel. (1) 693355

España: Philips Ibérica S.A.E.,
Dpto Aparatos de Medida, Martinez Villergas 2,
Apartado 2065, Madrid 27;
tel (1) 4042200
Service Centre:
Dpto Tco. de Instrumentación,
Calle de Albasanz 75, Madrid 17;
tel. (1) 2047100

Ethiopia: Philips Ethiopia (Priv. Ltd. Co.),
Ras Abebe Areguay Avenue,
P.O.B. 2565,
Addis Ababa; tel. 448300

Finland: See Suomi

France: S.A. Philips Industrielle et Commerciale,
Division S&I,
105 Rue de Paris, 93 002 Bobigny;
tel. (1) 8301111

Great Britain: Pye Unicam Ltd., York Street,
Cambridge CB1-2PX, tel. (223) 358866
Service Centre:
Beddington Lane, Croydon, Surrey CR9-4EN;
tel. (1) 6843670

Greece: See Hellas

Hellas: Philips S.A. Hellénique,
54 Avenue Syngrou, P.O. Box 153,
Athens 403; tel. (1) 9215311

Hong Kong: Philips Hong Kong Ltd.,
P.O.B. 2108, St. George's Building, 21st floor,
Hong Kong city; tel. (5) 249246
Service Centre:
Hopewell Centre, 16th floor,
No. 17, Kennedy Road,
Wanchai, Hong Kong;
tel. (5) 283575

India: Peico Electronics & Electricals Ltd.,
S&I Equipment, Shivasagar Estate,
Block "A", Dr. Annie Besant Road,
P.O.B. 6598, Worli, Bombay 4000 18 (WB);
tel. 391431

Indonesia: P.T. Philips Development Corporation,
Jalan Let. Jen Haryone M.T. Kav. 17,
P.O.B. 2287, Jakarta-Selatan; tel. (21) 820808

Iran: Philips Iran Ltd., P.O.B. 1297, Teheran;
tel. 662281/5

Iraq: Philips Iraq W.L.L., Munir Abbas Building,
4th floor; South Gate, P.O. box 5749, Baghdad;
tel. 8880409

Island: Heimilisteaki SF, Sættún 8, Reykjavik;
tel. 24000

Islas Canarias: Philips Ibérica S.A.E.,
Triana 132, Las Palmas, Casilla 39 41,
Santa Cruz de Tenerife

Italia: Philips S.p.A., Sezione S&I/T&M;
Viale Eivezia 2, 20052 Monza; tel. (39) 36351

Japan: See Nippon

Jordan: Philips Delegate Office,
P.O. Box 35268, Amman; tel. 43998

Kenya: Philips (Kenya) Ltd.,
01 Kalou Road, Industrial Area,
P.O.B. 30554, Nairobi; tel. 557999

Kuwait: Delegate Office of Philips Industries,
P.O. Box 3801, Safat, Kuwait; tel. 428678

Lebanon: Philips Middle East S.A.R.L.,
P.O. Box 11670, Beirut, tel. 382300

Malaysia: Philips Malaysia Sdn Bhd.,
Lot 2, Jalan 222, Section 14,
P.O. Box 2163, Petaling Jaya,
Selangor; tel. 574411

México: Philips Mexicana S.A. de C.V.,
Div. Científico Industrial, Calle Durango 167,
Apartado Postal 24-328, Mexico 7 (D.F.);
tel. 544-91-99

Morocco: S.A.M.T.E.L., Casa Bandoeng,
B.P. 10896, Casablanca; tel. 303192

Nederland: Philips Nederland B.V.,
Hoofdgroep PPS, Boschdijk 525, Gebouw VB,
5600 VB Eindhoven; tel. 793333

Service Centre:
Technische Service Prof. Aktiviteiten
Hurksestraat 42, Gebouw HBK,
5600 MC Eindhoven; tel. 723094
Ned. Antillen: Philips Antillana N.V.,
Postbus 523, Willemstad, Curaçao;
tel. 37575/37475

New Zealand: Philips Electrical Industries of N.Z. Ltd.,
Scientific and Industrial Equipment Division;
Horlor Street, P.O. Box 2097,
Naenae, Wellington; tel. 678639

Nigeria: Associated Electronic Products (Nigeria) Ltd.,
Ikoro Road, P.O.B. 1921, Lagos; tel. 900160/61

Nippon: NF Trading Co. Ltd.,
Kirimoto Bldg. 11-2,
Tsunashima Higashi 1 - Chome, Kohoku-ku,
Yokohama

Norge: Norsk A.S. Philips,
Industri og Forskning, Essendrops gate 5,
Postboks 5040, Oslo 3; tel. (2) 463890

Service Centre:
Postboks 1 Manglerud, Oslo 6; tel. (2) 336270

Oesterreich: Oesterreichische Philips Industrie GmbH,
Abteilung Industrie Elektronik,
Breitenfurterstrasse 219, A-1230 Wien;
tel. (222)-841611/15.

Pakistan: Philips Electrical Co. of Pakistan Ltd.,
El-Markz, M.A. Jinnach Road, P.O.B. 7101,
Karachi 3; tel. 70071

Paraguay: Philips del Paraguay S.A.,
Casilla de Correo 605, Asunción;
tel. 48045/46919

Perú: Philips Peruana S.A.,
Av. Alfonso Ugarte 1268
Apartado Aereo 1841, Lima 100, tel. 326070

Philippines: Philips Industrial Development Inc.,
2246 Pasong Tamo, P.O.B. 911,
Makati Rizal, 3116, Manila; tel. 868951/868959

Portugal: Philips Portuguesa S.A.R.L.,
Av. Eng. Duarte Pacheco 6, Apartado 1331, Lisboa 1000;
tel. (19) 683121/9
Service Centre:
Serviços Técnicos Profissionais, Outurela,
2795 Linda-a-Velha; tel. (19) 2180071

Saudi Arabia: Delegate Office Philips Industries,
Sabreen Bldg., Airport Road, P.O. Box 9844,
Riyadh; tel. 4777808/4778463

Schweiz-Suisse/Svizzera: Philips A.G.,
Allmendstrasse 140, Postfach, CH-8027 Zurich;
tel. (1) 4882211/4882629

Singapore: Philips Singapore Private Ltd.,
Lorong 1, Tao Payoh, 1st floor,
P.O. Box 340, Toa Payoh Central Post Office,
Singapore 1231; tel. (2) 538811
Service Centre:
403 Delta House, 4th floor,
No. 2 Alexandra Road,
Singapore 0315; tel. 2712555

South Africa: South African Philips (Pty) Ltd.,
2 Herb Street, New Doornfontein, P.O.B. 7703,
Johannesburg 2000; tel. (11) 6140411

South-Korea: Philips Electronics (Korea) Ltd.,
P.O. Box 3680, Seoul; tel. 794 4202

Suomi: Oy Philips Ab.,
Kaivokatu 8,
P.O. Box 10255,
00101 Helsinki 10; tel. 17271
Service Centre:
P.O. Box 11, SF-02631 Espoo 63;
tel. (0) 523122

Sverige: Svenska A.B. Philips,
Philips Industrietelefon, Lidingsgövägen 50,
Fack, S11584 Stockholm; tel. (8) 635000

Syria: Philips Moyen-Orient S.A., Rue Fardoss 79,
Immeuble Kassas and Sadate, B.P. 2442, Damas,
tel. 118605/221650/228003

Taiwan: Philips Taiwan Ltd.,
San Min Building, P.O. Box 22978, Taipei;
tel. (2) 5631717

Tanzania: Philips (Tanzania) Ltd.,
Box. 20104, Dar es Salaam; tel. 29571/4

Thailand: Philips Electrical Co. of Thailand Ltd.,
283 Silom Road, P.O. Box 961, Bangkok 5;
tel. 233-6330/9

Tunisia: S.T.I.E.T., 32 bis, Rue Ben Ghedhahem,
Tunis; tel. 244268/243025

Türkiye: Türk Philips Ticaret A.S.,
Posta Kutusu 504, Bevoğlu,
Istanbul 1; tel. 435910

United Arab Emirates: Philips Delegate Office,
P.O. Box 2567, Dubai; tel. 220641/220642

Uruguay: Industrias Philips del Uruguay S.A.,
Avda Uruguay 1287, Casilla de Correo 294,
Montevideo; tel. 915641/44

U.S.A.:
Philips Test and Measuring Instruments Inc.,
California, Garden Grove 92645
12882 Valley View Street, Suite 9;
tel. : (213) 594-8741/ (714) 898-5000
California, Milpitas 95035
489 Valley Way;
tel. (408) 946-6722
Florida, Orlando 32805
750 S Orange Blossom Trail, Suite 206;
tel. (305) 422-8131
Georgia, Norcross 30071
7094 Peachtree Industrial Blvd., Suite 220;
tel. (404) 586-0238
Illinois, Elk Grove Village 60007
175 Scott Street;
tel. (312) 640-7860
Massachusetts, Woburn 01801
21 Olympia Avenue;
tel. (617) 935-3972
Minnesota, Minneapolis 55420
7801 Metro Parkway, Suite 109;
tel. (612) 854-2426
New Jersey, Mahwah 07430
85 McKee Drive;
tel. (201) 529-3800, Toll-free (800) 631-7172

Venezuela: Industrias Venezolanas Philips S.A.,
Apartado Aereo 1167, Caracas 107;
tel. (2) 393811/353533

Zaire: S.A.M.E./S.Z.A.R.L., B.P. 16636, Kinshasa,
tel. 31887/8

Zambia: Philips Electrical Zambia Ltd.,
Mweneshi Road, P.O.B. 31878, Lusaka;
tel. 218511/218701

Zimbabwe: Philips Electrical (PVT) Ltd.,
62, Umtali Road, P.O. Box 994, Beverley/Saisbury;
tel. 47211

For information on change of address:
N.V. Philips' Gloeilampenfabrieken,
Test and Measuring Instruments, Building TQ III-4,
5600 MD Eindhoven - The Netherlands

For countries not listed:
N.V. Philips' Gloeilampenfabrieken, S&I Export;
Test and Measuring Instruments, Building TQIII-3,
5600 MD Eindhoven - The Netherlands